

2024

POWER

TRANSMISSION



BEA INGRANAGGI S.P.A.



BEA INGRANAGGI S.p.A.

EDIZIONE 2024

21044 CAVARIA CON PREMEZZO (VA) ITALY
VIA TITO MINNITI, 158
TEL. +39 0331 214.111 - FAX +39 0331 214.222
bea@beaingranaggi.com - www.beaingranaggi.com

DEPOSITO DI PADOVA
35010 Villafranca Padovana (PD) - Viale delle Industrie, 9
Tel. +39 049 907.0422 - +39 049 761.699
Fax +39 049 761.997
padova@beaingranaggi.com

LUFRA S.A.
26740 Montboucher Sur Jabron - FRANCE
Z.A Fontgrave - 50 Rue Denis Papin
Tel. +33 475 468.811 - Fax +33 475 468.606
commercial@lufra.fr - www.lufra.fr

BEA ANTRIEBSTECHNIK GmbH
Neckarstraße, 14 - 72666 Neckartailfingen - GERMANY
Tel. +49 7127 980.120 - Fax +49 7127 980.1222
info@bea-antriebstechnik.de - www.bea-antriebstechnik.de

BEA TRANSMISION 98 S.L.
20829 Itziar - Deba (Guipúzcoa) - SPAIN
Parque Empresarial Itziar, Parcela 4, Sector F-2, Naves 2-3
Tel. +34 943 199.464 - Fax +34 943 199.458
comercial@beatransmision.com - www.beatransmision.com

DAN-BELT TRANSMISION INDUSTRIAL S.L.
08980 Sant Feliu De Llobregat (Barcelona) - SPAIN
Calle Agricultura 17, Poligono El Pla, Naves 6-8-10
Tel. +34 936 327 300
danbelt@danbelt.com - www.danbelt.com















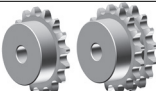

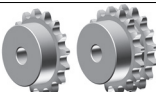
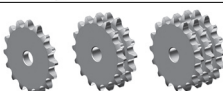

Marchi depositati
Registered Trade Mark





INDICE INDEX



















DA PAGINA

	PIGNONI SEMPLICI PER CATENA A RULLI "SYSTEM BEA" SIMPLEX SPROCKETS FOR ROLLER CHAINS "SYSTEM BEA"	8
	PIGNONI DOPPI PER CATENA A RULLI "SYSTEM BEA" DUPLEX SPROCKETS FOR ROLLER CHAINS "SYSTEM BEA"	18
	PIGNONI PER CATENA A RULLI SPROCKETS FOR ROLLER CHAINS	25
	PIGNONI PER CATENA A RULLI CON TEMPERA INDUZIONE SUI DENTI SPROCKETS FOR ROLLER CHAINS WITH HARDENED TEETH	39
	PIGNONI PER PER BUSSOLA CONICA SPROCKETS FOR TAPER BUSHES	42
	PIGNONI PER PER BUSSOLA CONICA TEMPERATI AD INDUZIONE SPROCKETS FOR TAPER BUSHES WITH HARDENED TEETH	50
	PIGNONI SEMPLICI PER CATENE A RULLI IN ACCIAIO INOX SIMPLEX SPROCKETS IN STAINLESS STEEL FOR ROLLER CHAINS	52
	PIGNONI IN GHISA PER CATENE A RULLI CAST IRON SPROCKETS FOR ROLLER CHAINS	54
	PIGNONI PER CATENE A RULLI "ASA" SPROCKETS FOR ROLLER CHAINS "ASA"	58
	CORONE PER CATENE A RULLI PLATE WHEELS FOR ROLLER CHAINS	69
	CORONE DOPPIE PER DUE CATENE SEMPLICI DOUBLE SIMPLE SPROCKETS	91
	PIGNONI TENDICATENA COMPLETI DI CUSCINETTO A SFERE - ELEMENTI DI FISSAGGIO CHAIN-STRETCHER SPROCKETS WITH BALL BEARING - LOCKING PARTS	95
	PIGNONI TENDICATENA COMPLETI DI CUSCINETTO A SFERE IN ACCIAIO INOX CHAIN-STRETCHER SPROCKETS WITH BALL BEARING IN STAINLESS STEEL	96
	RUOTE PER CATENE A CERNIERA WHEELS FOR TABLE TOP CHAINS	96
	PIGNONI TENDICATENA CON SFERE E VITE DI FISSAGGIO CHAIN-STRETCHER SPROCKETS WITH BALLS AND FASTENING BOLT	97
	RUOTE LIBERE SEMPLICI SIMPLEX FREE WHEELS	97
	MOZZI SALDABILI CON PREFORO WELDING HUBS WITH PILOT BORE	98
	MOZZI SMONTABILI PER BUSSOLA CONICA "MSM" DEMOUNTABLE HUBS FOR TAPER BUSHES	99
	MOZZI SALDABILI PER BUSSOLA CONICA "MSC" WELD - ON HUBS FOR TAPER BUSHES	99



INDICE INDEX

DA PAGINA

	CORONE PER CATENE A RULLI "ASA" PLATE WHEELS FOR ROLLER CHAINS "ASA"	101
	CORONE PER CATENE TRASPORTO PLATE WHEELS FOR CONVEYOR CHAINS	111
	PIGNONI PER CATENE TRASPORTO SPROCKETS FOR CONVEYOR CHAINS	114
	CATENE A RULLI SERIE EUROPEA "BEA" ROLLER CHAINS EUROPEAN STANDARD "BEA"	120
	CATENE A RULLI SERIE AMERICANA "BEA" ROLLER CHAINS AMERICAN STANDARD "BEA"	121
	CATENE A RULLI CON PIATRE A PROFILO DIRITTO "BEA" ROLLER CHAINS WITH STRAIGHT PLATES "BEA"	122
	CATENE A PERNI FORATI "BEA" HOLLOW PINS CHAINS "BEA"	122
	CATENE A RULLI AUTOLUBRIFICATI "BEA" SINTERED BUSH CHAINS "BEA"	123
	CATENE A RULLI "O-RING" - "BEA" "O-RING" CHAINS "BEA"	123
	CATENE A RULLI CON ATTACCHI "BEA" ROLLER CHAINS WITH ATTACHMENTS "BEA"	124
	CATENE A RULLI CON PERNI SPORGENTI "BEA" EXTENDED PIN CHAINS "BEA"	128
	CATENE PER ACCUMULO "BEA" ACCUMULATOR CHAINS "BEA"	128
	CATENE A RULLI NICHELATA "BEA" NICKEL PLATED ROLLER CHAINS "BEA"	129
	CATENE A RULLI IN ACCIAIO INOX "BEA" ROLLER CHAINS IN STAINLESS STEEL "BEA"	130
	CATENE A RULLI CON PIASTRE A PROFILO DIRITTO IN ACCIAIO INOX "BEA" ROLLER CHAINS IN STAINLESS STEEL WITH STRAIGHT PLATES "BEA"	131
	CATENE A PERNI FORATI IN ACCIAIO INOX "BEA" ROLLER CHAINS IN STAINLESS STEEL WITH HOLLOW PINS "BEA"	131
	CATENE A RULLI SERIE EUROPEA "SATURN" ROLLER CHAINS EUROPEAN STANDARD "SATURN"	138
	CATENE A RULLI CON PIASTRE A PROFILO DIRITTO "SATURN" ROLLER CHAINS WITH STRAIGHT PLATES "SATURN"	139
	CATENE A RULLI IN ACCIAIO INOX "SATURN" ROLLER CHAINS IN STAINLESS STEEL "SATURN"	140



INDICE INDEX

DA PAGINA

	GUIDACATENE IN POLIETILENE CHAIN GUIDE RAILS IN POLYETHYLENE	143
	SMONTACATENA E TENDITORE PER MONTAGGIO CATENA DETACHER & CONNECTING TOOL FOR CHAIN	146
	TENDICATENA - ELEMENTI ELASTICI CHAIN TENSIONERS - RUBBER SUSPENSION UNIT	150
	RUOTE DENTATE CILINDRICHE CYLINDRICAL GEARS	160
	RUOTE DENTATE CILINDRICHE TEMPERATE AD INDUZIONE CYLINDRICAL GEARS WITH HARDENED TEETH	169
	RUOTE DENTATE CILINDRICHE IN ACCIAIO INOX CYLINDRICAL GEARS IN STAINLESS STEEL	172
	CREMAGLIERE INTESTATE PER IL MONTAGGIO CONTINUO RACKS FOR CONTINUOUS MOUNTING	175
	CREMAGLIERE INTESTATE PER IL MONTAGGIO CONTINUO TEMPRATE AD INDUZIONE RACKS FOR CONTINUOUS MOUNTING HARDENED TEETH	176
	CREMAGLIERE INTESTATE PER IL MONTAGGIO CONTINUO - INOX RACKS FOR CONTINUOUS MOUNTING IN STAINLESS STEEL	176
	RUOTE DENTATE CONICHE DENTI DIRITTI TIPO - A - B CONICAL STRAIGHT TOOTHED GEARS TYPE - A - B	177
	RUOTE DENTATE CONICHE DENTI SPIROIDALI CONICAL SPIRAL TOOTHED GEARS	183
	PULEGGE DENTATE PER CINGHIE POSITIVE TIMING BELT PULLEYS	188
	PULEGGE DENTATE A BUSSOLA CONICA PER CINGHIE POSITIVE TIMING BELT PULLEYS FOR TAPER BUSHES	200
	PULEGGE DENTATE PER CINGHIE HTD® HTD® TIMING BELT PULLEYS	207
	PULEGGE DENTATE A BUSSOLA CONICA PER CINGHIE HTD® HTD® TIMING BELT PULLEYS FOR TAPER BUSHES	221
	PULEGGE DENTATE "PCB" A BUSSOLA CONICA PER CINGHIE SYNCHROCHAIN "PCB" SYNCHROCHAIN TIMING BELT PULLEYS FOR TAPER BUSHES	231
	PULEGGE DENTATE PASSO METRICO METRIC PULLEYS	241
	BARRE PER CINGHIE DENTATE TIMING BELT BARS	256
	FLANGE ZINCATE PER PULEGGE DENTATE ZINC PLATED FLANGES FOR PULLEYS	263



INDICE INDEX







DA PAGINA

	PIASTRE DI BLOCCAGGIO PER CINGHIE DENTATE CLAMPING BELT PLATES	267
	PULEGGE A GOLE TRAPEZOIDALI PER BUSSOLA CONICA V-BELT PULLEYS FOR TAPER BUSH	271
	PULEGGE SCANALATE POLY-V PER BUSSOLA CONICA POLY-V PULLEYS FOR TAPER BUSH	301
	BUSSOLE CONICHE DI SERRAGGIO TAPER BUSHES	310
	VITI DI SERRAGGIO PER BUSSOLE CONICHE SCREW FOR TAPER BUSHES	314
	CALETTATORI LOCKING ASSEMBLIES	317
	CALETTATORI IN ACCIAIO INOX LOCKING ASSEMBLIES IN STAINLEES STEEL	331
	SLITTE TENDICINGHIA PER MOTORI ELETTRICI ADJUSTABLE MOTOR MOUNTING	339
	GIUNTI ELASTICI TORSIONALI "GEB" TORSIONAL FLEXIBLE COUPLINGS "GEB"	342
	GIUNTI ELASTICI SENZA GIOCO "GEB-SG" FLEXIBLE COUPLINGS BACKLASH "GEB-SG"	347
	GIUNTI ELASTICI TORSIONALI "GEB-HRC" TORSIONAL FLEXIBLE COUPLINGS "GEB-HRC"	350
	GIUNTI DENTATI "GFB" GEAR COUPLINGS "GFB"	352
	GIUNTI RIGIDI RIGID COUPLINGS	354
	GIUNTI RIGIDI IN ACCIAIO INOX RIGID COUPLINGS IN STAINLESS STEEL	356
	GIUNTI FLESSIBILI A CATENA CHAIN COUPLINGS	358
	ANELLI DI BLOCCAGGIO - BRUNITI SHAFT COLLARS - BLACK OXIDE	360
	ANELLI DI BLOCCAGGIO IN ACCIAIO INOX SHAFT COLLARS IN STAINLESS STEEL	364
	TESTE A SNODO DIN 648 - LUBRIFICABILI ROD ENDS DIN 648 - WITH LUBRICATION	368
	SUPPORTI PER CUSCINETTI IN LAMIERA - ZINCATI BALL FLANGE BEARING IN STEEL - ZINC PLATED	370



INDICE INDEX

DA PAGINA

	SUPPORTI PER CUSCINETTI IN GHISA BALL FLANGE BEARING IN CAST IRON	372
	SUPPORTI PER CUSCINETTI IN ACCIAIO INOX BALL FLANGE BEARING IN STAINLESS STEEL	379
	CUSCINETTI RADIALI AD UNA CORONA DI SFERE SEALED RADIAL DEEP GROOVE BALL BEARINGS	382
	PIGNONI TENDICTENA - MATERIALE TERMOPLASTICO ADJUSTABLE MOTOR MOUNTING	389
	RUOTE DENTATE CILINDRICHE- MATERIALE TERMOPLASTICO CYLINDRICAL GEARS - THERMOPLASTIC MATERIAL	390
	RUOTE DENTATE CONICHE DENTI DIRTTI - MATERIALE TERMOPLASTICO CONICAL STRAIGHT TOOTHED GEARS - THERMOPLASTIC MATERIAL	395
	PULEGGE DENTATE - MATERIALE TERMOPLASTICO TIMING BELTS PULLEYS - THERMOPLASTIC MATERIAL	396

--	--	--

--	--	--

--	--	--

--	--	--

--	--	--

--	--	--

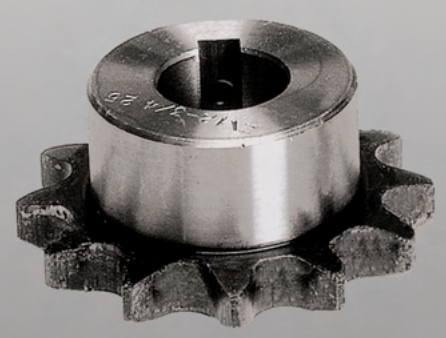
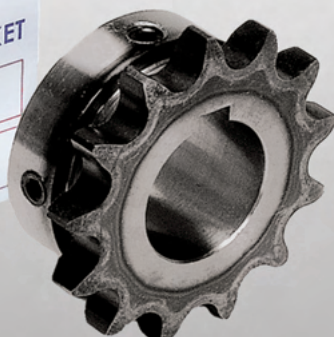



3/8" x 7/32"
9,525 x 5,72 mm
Rullo 6,35 mm
06B-1

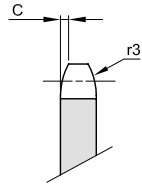

B1	C	r3
5,3	1	10

Materiale: Acciaio C45 - tipo ^ eseguiti con cava e un foro a 90°

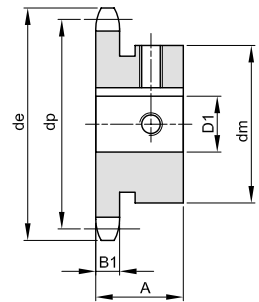
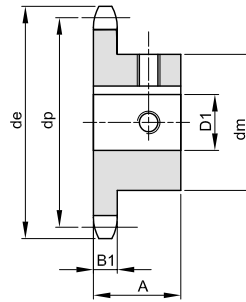

TIPO *

Z	de	dp	codice	dm	D1	A	Kg.
10	34,5	30,82	SB101330010010	24*	10^	20	0,06
10	34,5	30,82	SB101330010012	26*	12	20	0,07
10	34,5	30,82	SB101330010014	29*	14	20	0,07
11	37,5	33,80	SB101330011010	24*	10^	25	0,09
11	37,5	33,80	SB101330011012	26*	12	25	0,09
11	37,5	33,80	SB101330011014	29*	14	25	0,10
11	37,5	33,80	SB101330011015	30*	15	25	0,10
11	37,5	33,80	SB101330011016	31*	16	25	0,11
12	40,5	36,80	SB101330012010	25	10^	25	0,10
12	40,5	36,80	SB101330012012	26*	12	25	0,10
12	40,5	36,80	SB101330012014	29*	14	25	0,11
12	40,5	36,80	SB101330012015	30*	15	25	0,11
12	40,5	36,80	SB101330012016	31*	16	25	0,11
13	43,5	39,80	SB101330013010	28	10^	25	0,13
13	43,5	39,80	SB101330013012	28	12	25	0,12
13	43,5	39,80	SB101330013014	28	14	25	0,11
13	43,5	39,80	SB101330013015	28	15	25	0,11
13	43,5	39,80	SB101330013016	31*	16	25	0,12
13	43,5	39,80	SB101330013018	34*	18	25	0,13
14	46,5	42,80	SB101330014010	31	10^	25	0,16
14	46,5	42,80	SB101330014012	31	12	25	0,15
14	46,5	42,80	SB101330014014	31	14	25	0,17
14	46,5	42,80	SB101330014015	31	15	25	0,14
14	46,5	42,80	SB101330014016	31	16	25	0,13
14	46,5	42,80	SB101330014018	31	18	25	0,12
14	46,5	42,80	SB101330014019	35*	19	25	0,14
15	49,5	45,81	SB101330015012	34	12	25	0,18
15	49,5	45,81	SB101330015014	34	14	25	0,18
15	49,5	45,81	SB101330015015	34	15	25	0,17
15	49,5	45,81	SB101330015016	34	16	25	0,17
15	49,5	45,81	SB101330015018	34	18	25	0,15
15	49,5	45,81	SB101330015019	34	19	25	0,15
15	49,5	45,81	SB101330015020	34	20	25	0,14
15	49,5	45,81	SB101330015022	42*	22	25	0,19
15	49,5	45,81	SB101330015024	42*	24	25	0,17
15	49,5	45,81	SB101330015025	42*	25	25	0,16
16	52,5	48,82	SB101330016012	37	12	28	0,24
16	52,5	48,82	SB101330016014	37	14	28	0,23
16	52,5	48,82	SB101330016015	37	15	28	0,23
16	52,5	48,82	SB101330016016	37	16	28	0,22
16	52,5	48,82	SB101330016018	37	18	28	0,21
16	52,5	48,82	SB101330016019	37	19	28	0,20
16	52,5	48,82	SB101330016020	37	20	28	0,20

Z	de	dp	codice	dm	D1	A	Kg.
16	52,5	48,82	SB101330016022	37	22	28	0,18
16	52,5	48,82	SB101330016024	42*	24	28	0,21
16	52,5	48,82	SB101330016025	42*	25	28	0,20
17	55,5	51,83	SB101330017012	40	12	28	0,28
17	55,5	51,83	SB101330017014	40	14	28	0,28
17	55,5	51,83	SB101330017015	40	15	28	0,27
17	55,5	51,83	SB101330017016	40	16	28	0,26
17	55,5	51,83	SB101330017018	40	18	28	0,25
17	55,5	51,83	SB101330017019	40	19	28	0,24
17	55,5	51,83	SB101330017020	40	20	28	0,24
17	55,5	51,83	SB101330017022	40	22	28	0,23
17	55,5	51,83	SB101330017024	46*	24	28	0,26
17	55,5	51,83	SB101330017025	46*	25	28	0,26
18	58,6	54,85	SB101330018012	40	12	28	0,30
18	58,6	54,85	SB101330018014	40	14	28	0,28
18	58,6	54,85	SB101330018015	43	15	28	0,31
18	58,6	54,85	SB101330018016	43	16	28	0,31
18	58,6	54,85	SB101330018018	43	18	28	0,29
18	58,6	54,85	SB101330018019	43	19	28	0,29
18	58,6	54,85	SB101330018020	43	20	28	0,28
18	58,6	54,85	SB101330018022	43	22	28	0,27
18	58,6	54,85	SB101330018024	43	24	28	0,25
18	58,6	54,85	SB101330018025	43	25	28	0,24
19	61,6	57,87	SB101330019012	40	12	28	0,31
19	61,6	57,87	SB101330019014	40	14	28	0,30
19	61,6	57,87	SB101330019015	45	15	28	0,35
19	61,6	57,87	SB101330019016	45	16	28	0,35
19	61,6	57,87	SB101330019018	45	18	28	0,33
19	61,6	57,87	SB101330019019	45	19	28	0,33
19	61,6	57,87	SB101330019020	45	20	28	0,32
19	61,6	57,87	SB101330019022	45	22	28	0,31
19	61,6	57,87	SB101330019024	45	24	28	0,29
19	61,6	57,87	SB101330019025	45	25	28	0,28
20	64,6	60,89	SB101330020012	40	12	28	0,32
20	64,6	60,89	SB101330020014	40	14	28	0,31
20	64,6	60,89	SB101330020015	46	15	28	0,38
20	64,6	60,89	SB101330020016	46	16	28	0,37
20	64,6	60,89	SB101330020018	46	18	28	0,36
20	64,6	60,89	SB101330020019	46	19	28	0,35
20	64,6	60,89	SB101330020020	46	20	28	0,34
20	64,6	60,89	SB101330020022	46	22	28	0,33
20	64,6	60,89	SB101330020024	46	24	28	0,31
20	64,6	60,89	SB101330020025	46	25	28	0,30



1/2" x 5/16"
12,7 x 7,75 mm
Rullo 8,51 mm
08B-1

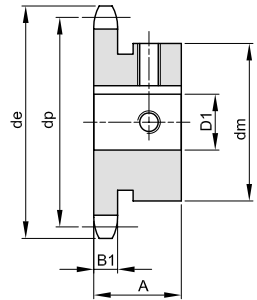
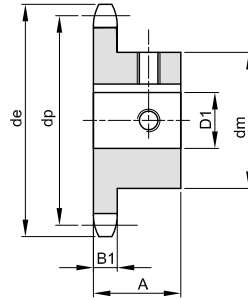
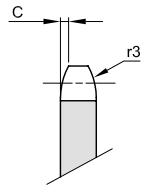

TIPO *

Materiale: Acciaio C45

Z	de	dp	codice	dm	D1	A	Kg.
10	45,9	41,10	SB101340010012	26	12	25	0,12
10	45,9	41,10	SB101340010014	26	14	25	0,11
10	45,9	41,10	SB101340010015	31*	15	25	0,12
10	45,9	41,10	SB101340010016	31*	16	25	0,12
11	49,9	45,07	SB101340011012	29	12	25	0,15
11	49,9	45,07	SB101340011014	29	14	25	0,14
11	49,9	45,07	SB101340011015	31*	15	25	0,14
11	49,9	45,07	SB101340011016	31*	16	25	0,14
11	49,9	45,07	SB101340011018	37*	18	25	0,16
11	49,9	45,07	SB101340011019	37*	19	25	0,16
12	53,9	49,07	SB101340012012	33	12	28	0,21
12	53,9	49,07	SB101340012014	33	14	28	0,20
12	53,9	49,07	SB101340012015	33	15	28	0,19
12	53,9	49,07	SB101340012016	33	16	28	0,19
12	53,9	49,07	SB101340012018	33	18	28	0,18
12	53,9	49,07	SB101340012019	33	19	28	0,17
12	53,9	49,07	SB101340012020	33	20	28	0,17
12	53,9	49,07	SB101340012022	40*	22	28	0,20
12	53,9	49,07	SB101340012024	41*	24	28	0,19
12	53,9	49,07	SB101340012025	42*	25	28	0,19
13	57,9	56,06	SB101340013012	33	12	28	0,27
13	57,9	56,06	SB101340013014	33	14	28	0,26
13	57,9	56,06	SB101340013015	37	15	28	0,26
13	57,9	56,06	SB101340013016	37	16	28	0,25
13	57,9	56,06	SB101340013018	37	18	28	0,24
13	57,9	56,06	SB101340013019	37	19	28	0,23
13	57,9	56,06	SB101340013020	37	20	28	0,22
13	57,9	56,06	SB101340013022	37	22	28	0,21
13	57,9	56,06	SB101340013024	42*	24	28	0,22
13	57,9	56,06	SB101340013025	42*	25	28	0,21
13	57,9	56,06	SB101340013028	45*	28	28	0,21
14	61,9	57,07	SB101340014012	37	12	28	0,32
14	61,9	57,07	SB101340014014	37	14	28	0,31
14	61,9	57,07	SB101340014015	41	15	28	0,31
14	61,9	57,07	SB101340014016	41	16	28	0,30
14	61,9	57,07	SB101340014018	41	18	28	0,29
14	61,9	57,07	SB101340014019	41	19	28	0,28
14	61,9	57,07	SB101340014020	41	20	28	0,28
14	61,9	57,07	SB101340014022	41	22	28	0,27
14	61,9	57,07	SB101340014024	41	24	28	0,25
14	61,9	57,07	SB101340014025	41	25	28	0,24
14	61,9	57,07	SB101340014028	48*	28	28	0,27
15	65,9	61,09	SB101340015012	37	12	28	0,37
15	65,9	61,09	SB101340015014	37	14	28	0,36
15	65,9	61,09	SB101340015015	45	15	28	0,37

Z	de	dp	codice	dm	D1	A	Kg.
15	65,9	61,09	SB101340015016	45	16	28	0,37
15	65,9	61,09	SB101340015018	45	18	28	0,36
15	65,9	61,09	SB101340015019	45	19	28	0,35
15	65,9	61,09	SB101340015020	45	20	28	0,34
15	65,9	61,09	SB101340015022	45	22	28	0,32
15	65,9	61,09	SB101340015024	45	24	28	0,31
15	65,9	61,09	SB101340015025	45	25	28	0,30
15	65,9	61,09	SB101340015028	45	28	28	0,27
15	65,9	61,09	SB101340015030	52*	30	28	0,32
15	65,9	61,09	SB101340015032	52*	32	28	0,30
16	69,9	65,10	SB101340016015	50	15	28	0,47
16	69,9	65,10	SB101340016016	50	16	28	0,46
16	69,9	65,10	SB101340016018	50	18	28	0,44
16	69,9	65,10	SB101340016019	50	19	28	0,43
16	69,9	65,10	SB101340016020	50	20	28	0,43
16	69,9	65,10	SB101340016022	50	22	28	0,40
16	69,9	65,10	SB101340016024	50	24	28	0,39
16	69,9	65,10	SB101340016025	50	25	28	0,38
16	69,9	65,10	SB101340016028	50	28	28	0,35
16	69,9	65,10	SB101340016030	50	30	28	0,34
16	69,9	65,10	SB101340016032	57*	32	28	0,40
17	74,0	69,11	SB101340017015	52	15	28	0,51
17	74,0	69,11	SB101340017016	52	16	28	0,51
17	74,0	69,11	SB101340017018	52	18	28	0,49
17	74,0	69,11	SB101340017019	52	19	28	0,48
17	74,0	69,11	SB101340017020	52	20	28	0,47
17	74,0	69,11	SB101340017022	52	22	28	0,45
17	74,0	69,11	SB101340017024	52	24	28	0,44
17	74,0	69,11	SB101340017025	52	25	28	0,43
17	74,0	69,11	SB101340017028	52	28	28	0,40
17	74,0	69,11	SB101340017030	52	30	28	0,39
17	74,0	69,11	SB101340017032	52	32	28	0,38
18	78,0	73,14	SB101340018016	52	16	28	0,53
18	78,0	73,14	SB101340018018	52	18	28	0,51
18	78,0	73,14	SB101340018019	52	19	28	0,50
18	78,0	73,14	SB101340018020	52	20	28	0,55
18	78,0	73,14	SB101340018022	56	22	28	0,53
18	78,0	73,14	SB101340018024	56	24	28	0,52
18	78,0	73,14	SB101340018025	56	25	28	0,51
18	78,0	73,14	SB101340018028	56	28	28	0,48
18	78,0	73,14	SB101340018030	56	30	28	0,46
18	78,0	73,14	SB101340018032	56	32	28	0,43
18	78,0	73,14	SB101340018035	56	35	28	0,41
18	78,0	73,14	SB101340018038	56	38	28	0,39
19	82,0	77,16	SB101340019016	52	16	28	0,55



1/2" x 5/16"
12,7 x 7,75 mm
Rullo 8,51 mm
08B-1

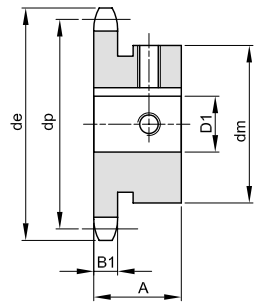
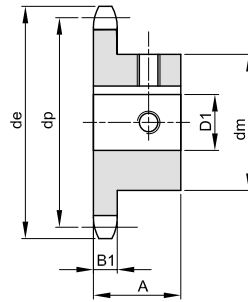
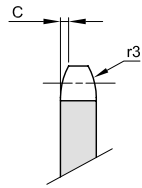

TIPO *

B1	C	r3
7,2	1,3	13

Materiale: Acciaio C45

Z	de	dp	codice	dm	D1	A	Kg.
19	82,0	77,16	SB101340019018	52	18	28	0,53
19	82,0	77,16	SB101340019019	52	19	28	0,5
19	82,0	77,16	SB101340019020	60	20	28	0,64
19	82,0	77,16	SB101340019022	60	22	28	0,62
19	82,0	77,16	SB101340019024	60	24	28	0,60
19	82,0	77,16	SB101340019025	60	25	28	0,59
19	82,0	77,16	SB101340019028	60	28	28	0,57
19	82,0	77,16	SB101340019030	60	30	28	0,55
19	82,0	77,16	SB101340019032	60	32	28	0,53
19	82,0	77,16	SB101340019035	60	35	28	0,49
19	82,0	77,16	SB101340019038	60	38	28	0,46
20	86,0	81,19	SB101340020016	55	16	28	0,64
20	86,0	81,19	SB101340020018	55	18	28	0,61
20	86,0	81,19	SB101340020019	55	19	28	0,59
20	86,0	81,19	SB101340020020	64	20	28	0,74
20	86,0	81,19	SB101340020022	64	22	28	0,72
20	86,0	81,19	SB101340020024	64	24	28	0,71
20	86,0	81,19	SB101340020025	64	25	28	0,70
20	86,0	81,19	SB101340020028	64	28	28	0,67
20	86,0	81,19	SB101340020030	64	30	28	0,65
20	86,0	81,19	SB101340020032	64	32	28	0,63
20	86,0	81,19	SB101340020035	64	35	28	0,61
20	86,0	81,19	SB101340020038	64	38	28	0,59
21	90,1	85,22	SB101340021016	55	16	28	0,74
21	90,1	85,22	SB101340021018	55	18	28	0,72
21	90,1	85,22	SB101340021019	55	19	28	0,71
21	90,1	85,22	SB101340021020	60	20	28	0,70
21	90,1	85,22	SB101340021022	60	22	28	0,68
21	90,1	85,22	SB101340021024	68	24	28	0,80
21	90,1	85,22	SB101340021025	68	25	28	0,79
21	90,1	85,22	SB101340021028	68	28	28	0,77
21	90,1	85,22	SB101340021030	68	30	28	0,75
21	90,1	85,22	SB101340021032	68	32	28	0,72
21	90,1	85,22	SB101340021035	68	35	28	0,69
21	90,1	85,22	SB101340021038	68	38	28	0,65
22	94,1	89,24	SB101340022016	55	16	28	0,84
22	94,1	89,24	SB101340022018	55	18	28	0,81
22	94,1	89,24	SB101340022019	55	19	28	0,80
22	94,1	89,24	SB101340022020	65	20	28	0,82
22	94,1	89,24	SB101340022022	65	22	28	0,80
22	94,1	89,24	SB101340022024	70	24	28	0,87
22	94,1	89,24	SB101340022025	70	25	28	0,86
22	94,1	89,24	SB101340022028	70	28	28	0,83
22	94,1	89,24	SB101340022030	70	30	28	0,81
22	94,1	89,24	SB101340022032	70	32	28	0,78

Z	de	dp	codice	dm	D1	A	Kg.
22	94,1	89,24	SB101340022035	70	35	28	0,75
22	94,1	89,24	SB101340022038	70	38	28	0,71
23	98,1	93,27	SB101340023019	65	19	28	0,86
23	98,1	93,27	SB101340023020	65	20	28	0,85
23	98,1	93,27	SB101340023022	70	22	28	0,93
23	98,1	93,27	SB101340023024	70	24	28	0,90
23	98,1	93,27	SB101340023025	70	25	28	0,89
23	98,1	93,27	SB101340023028	70	28	28	0,86
23	98,1	93,27	SB101340023030	70	30	28	0,84
23	98,1	93,27	SB101340023032	70	32	28	0,82
23	98,1	93,27	SB101340023035	70	35	28	0,79
23	98,1	93,27	SB101340023038	70	38	28	0,76
24	102,1	97,29	SB101340024019	65	19	28	0,91
24	102,1	97,29	SB101340024020	65	20	28	0,89
24	102,1	97,29	SB101340024022	70	22	28	0,92
24	102,1	97,29	SB101340024024	70	24	28	0,94
24	102,1	97,29	SB101340024025	70	25	28	0,93
24	102,1	97,29	SB101340024028	70	28	28	0,90
24	102,1	97,29	SB101340024030	70	30	28	0,88
24	102,1	97,29	SB101340024032	70	32	28	0,85
24	102,1	97,29	SB101340024035	70	35	28	0,82
24	102,1	97,29	SB101340024038	70	38	28	0,79
25	106,2	101,33	SB101340025019	65	19	28	0,94
25	106,2	101,33	SB101340025020	65	20	28	0,92
25	106,2	101,33	SB101340025022	70	22	28	0,99
25	106,2	101,33	SB101340025024	70	24	28	0,97
25	106,2	101,33	SB101340025025	70	25	28	0,97
25	106,2	101,33	SB101340025028	70	28	28	0,94
25	106,2	101,33	SB101340025030	70	30	28	0,92
25	106,2	101,33	SB101340025032	70	32	28	0,90
25	106,2	101,33	SB101340025035	70	35	28	0,86
25	106,2	101,33	SB101340025038	70	38	28	0,80
30	126,3	121,50	SB101340030025	75	25	30	1,31
30	126,3	121,50	SB101340030028	75	28	30	1,28
30	126,3	121,50	SB101340030030	80	30	30	1,37
30	126,3	121,50	SB101340030032	80	32	30	1,34
30	126,3	121,50	SB101340030035	80	35	30	1,31
30	126,3	121,50	SB101340030038	80	38	30	1,28



PIGNONI SEMPLICI PER CATENE A RULLI "SYSTEM BEA" - DIN 8187 - ISO 606

SIMPLEX SPROCKETS FOR ROLLER CHAINS "SYSTEM BEA" - DIN 8187 - ISO 606

5/8" x 3/8"
15,875 x 9,65 mm
 Rullo 10,16 mm
10B-1

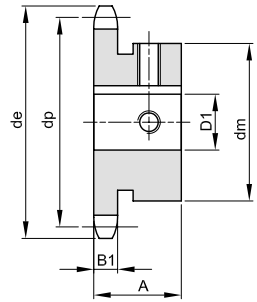
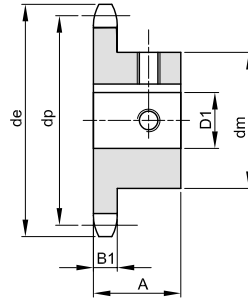
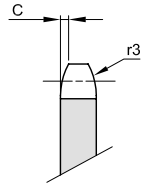

TIPO *

B1	C	r3
9,1	1,6	16

Materiale: Acciaio C45

Z	de	dp	codice	dm	D1	A	Kg.
10	58,3	51,37	SB101350010015	35	15	25	0,21
10	58,3	51,37	SB101350010016	35	16	25	0,21
10	58,3	51,37	SB101350010018	35	18	25	0,20
10	58,3	51,37	SB101350010019	35	19	25	0,20
10	58,3	51,37	SB101350010020	35	20	25	0,18
10	58,3	51,37	SB101350010024	42*	24	25	0,21
11	63,2	56,34	SB101350011015	37	15	30	0,30
11	63,2	56,34	SB101350011016	37	16	30	0,30
11	63,2	56,34	SB101350011018	37	18	30	0,28
11	63,2	56,34	SB101350011019	37	19	30	0,27
11	63,2	56,34	SB101350011020	37	20	30	0,26
11	63,2	56,34	SB101350011024	47*	24	30	0,30
11	63,2	56,34	SB101350011025	47*	25	30	0,29
11	63,2	56,34	SB101350011028	47*	28	30	0,27
12	68,2	61,34	SB101350012015	42	15	30	0,38
12	68,2	61,34	SB101350012016	42	16	30	0,37
12	68,2	61,34	SB101350012018	42	18	30	0,35
12	68,2	61,34	SB101350012019	42	19	30	0,34
12	68,2	61,34	SB101350012020	42	20	30	0,34
12	68,2	61,34	SB101350012022	42	22	30	0,33
12	68,2	61,34	SB101350012024	42	24	30	0,31
12	68,2	61,34	SB101350012025	42	25	30	0,30
12	68,2	61,34	SB101350012028	51*	28	30	0,34
12	68,2	61,34	SB101350012030	51*	30	30	0,32
12	68,2	61,34	SB101350012032	55*	32	30	0,34
13	73,2	66,32	SB101350013015	47	15	30	0,48
13	73,2	66,32	SB101350013016	47	16	30	0,47
13	73,2	66,32	SB101350013018	47	18	30	0,45
13	73,2	66,32	SB101350013019	47	19	30	0,44
13	73,2	66,32	SB101350013020	47	20	30	0,44
13	73,2	66,32	SB101350013022	47	22	30	0,42
13	73,2	66,32	SB101350013024	47	24	30	0,40
13	73,2	66,32	SB101350013025	47	25	30	0,39
13	73,2	66,32	SB101350013028	47	28	30	0,36
13	73,2	66,32	SB101350013030	47	30	30	0,34
13	73,2	66,32	SB101350013032	57*	32	30	0,40
14	78,2	71,34	SB101350014015	52	15	30	0,57
14	78,2	71,34	SB101350014016	52	16	30	0,56
14	78,2	71,34	SB101350014018	52	18	30	0,54
14	78,2	71,34	SB101350014019	52	19	30	0,54
14	78,2	71,34	SB101350014020	52	20	30	0,53
14	78,2	71,34	SB101350014022	52	22	30	0,51
14	78,2	71,34	SB101350014024	52	24	30	0,50

Z	de	dp	codice	dm	D1	A	Kg.
14	78,2	71,34	SB101350014025	52	25	30	0,49
14	78,2	71,34	SB101350014028	52	28	30	0,46
14	78,2	71,34	SB101350014030	52	30	30	0,44
14	78,2	71,34	SB101350014032	52	32	30	0,42
15	83,2	76,36	SB101350015019	57	19	30	0,67
15	83,2	76,36	SB101350015020	57	20	30	0,65
15	83,2	76,36	SB101350015022	57	22	30	0,63
15	83,2	76,36	SB101350015024	57	24	30	0,61
15	83,2	76,36	SB101350015025	57	25	30	0,60
15	83,2	76,36	SB101350015028	57	28	30	0,57
15	83,2	76,36	SB101350015030	57	30	30	0,55
15	83,2	76,36	SB101350015032	57	32	30	0,52
15	83,2	76,36	SB101350015035	57	35	30	0,49
16	88,3	81,37	SB101350016019	60	19	30	0,76
16	88,3	81,37	SB101350016020	60	20	30	0,74
16	88,3	81,37	SB101350016022	60	22	30	0,73
16	88,3	81,37	SB101350016024	60	24	30	0,71
16	88,3	81,37	SB101350016025	60	25	30	0,70
16	88,3	81,37	SB101350016028	60	28	30	0,68
16	88,3	81,37	SB101350016030	60	30	30	0,65
16	88,3	81,37	SB101350016032	60	32	30	0,62
16	88,3	81,37	SB101350016035	60	35	30	0,58
16	88,3	81,37	SB101350016038	60	38	30	0,54
17	93,3	86,39	SB101350017019	60	19	30	0,80
17	93,3	86,39	SB101350017020	60	20	30	0,78
17	93,3	86,39	SB101350017022	60	22	30	0,76
17	93,3	86,39	SB101350017024	60	24	30	0,75
17	93,3	86,39	SB101350017025	60	25	30	0,74
17	93,3	86,39	SB101350017028	60	28	30	0,71
17	93,3	86,39	SB101350017030	60	30	30	0,69
17	93,3	86,39	SB101350017032	60	32	30	0,65
17	93,3	86,39	SB101350017035	60	35	30	0,63
17	93,3	86,39	SB101350017038	60	38	30	0,60
18	98,3	91,42	SB101350018019	60	19	30	0,85
18	98,3	91,42	SB101350018020	60	20	30	0,83
18	98,3	91,42	SB101350018022	70	22	30	0,97
18	98,3	91,42	SB101350018024	70	24	30	0,96
18	98,3	91,42	SB101350018025	70	25	30	0,95
18	98,3	91,42	SB101350018028	70	28	30	0,93
18	98,3	91,42	SB101350018030	70	30	30	0,91
18	98,3	91,42	SB101350018032	70	32	30	0,87
18	98,3	91,42	SB101350018035	70	35	30	0,84
18	98,3	91,42	SB101350018038	70	38	30	0,80



5/8" x 3/8"
15,875 x 9,65 mm
Rullo 10,16 mm
10B-1

B1	C	r3
9,1	1,6	16

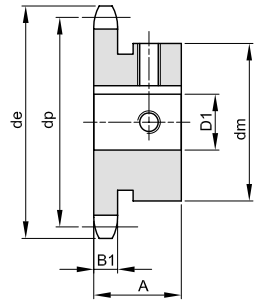
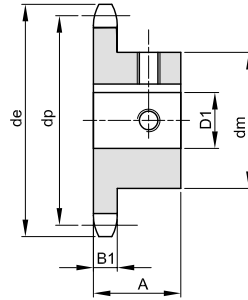
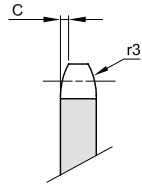

TIPO *

Materiale: Acciaio C45

Z	de	dp	codice	dm	D1	A	Kg.
18	98,3	91,42	SB101350018040	70	40	30	0,77
18	98,3	91,42	SB101350018042	70	42	30	0,74
19	103,3	96,45	SB101350019019	60	19	30	0,91
19	103,3	96,45	SB101350019020	60	20	30	0,90
19	103,3	96,45	SB101350019022	70	22	30	1,07
19	103,3	96,45	SB101350019024	70	24	30	1,02
19	103,3	96,45	SB101350019025	70	25	30	1,02
19	103,3	96,45	SB101350019028	70	28	30	1,00
19	103,3	96,45	SB101350019030	70	30	30	0,97
19	103,3	96,45	SB101350019032	70	32	30	0,94
19	103,3	96,45	SB101350019035	70	35	30	0,91
19	103,3	96,45	SB101350019038	70	38	30	0,86
19	103,3	96,45	SB101350019040	70	40	30	0,83
19	103,3	96,45	SB101350019042	70	42	30	0,80
20	108,4	101,49	SB101350020019	65	19	30	1,06
20	108,4	101,49	SB101350020020	65	20	30	1,04
20	108,4	101,49	SB101350020022	65	22	30	1,01
20	108,4	101,49	SB101350020024	70	24	30	1,08
20	108,4	101,49	SB101350020025	70	25	30	1,07
20	108,4	101,49	SB101350020028	75	28	30	1,13
20	108,4	101,49	SB101350020030	75	30	30	1,11
20	108,4	101,49	SB101350020032	75	32	30	1,08
20	108,4	101,49	SB101350020035	75	35	30	1,05
20	108,4	101,49	SB101350020038	75	38	30	1,01
20	108,4	101,49	SB101350020040	75	40	30	0,98
20	108,4	101,49	SB101350020042	75	42	30	0,95
21	113,4	106,52	SB101350021019	65	19	30	1,10
21	113,4	106,52	SB101350021020	65	20	30	1,08
21	113,4	106,52	SB101350021022	65	22	30	1,06
21	113,4	106,52	SB101350021024	70	24	30	1,13
21	113,4	106,52	SB101350021025	70	25	30	1,12
21	113,4	106,52	SB101350021028	75	28	30	1,15
21	113,4	106,52	SB101350021030	75	30	30	1,17
21	113,4	106,52	SB101350021032	75	32	30	1,14
21	113,4	106,52	SB101350021035	75	35	30	1,11
21	113,4	106,52	SB101350021038	75	38	30	1,08
21	113,4	106,52	SB101350021040	75	40	30	1,03
21	113,4	106,52	SB101350021042	75	42	30	0,99
22	118,4	111,55	SB101350022019	65	19	30	1,16
22	118,4	111,55	SB101350022020	65	20	30	1,14
22	118,4	111,55	SB101350022022	65	22	30	1,11
22	118,4	111,55	SB101350022024	70	24	30	1,20
22	118,4	111,55	SB101350022025	70	25	30	1,19

Z	de	dp	codice	dm	D1	A	Kg.
22	118,4	111,55	SB101350022028	80	28	30	1,35
22	118,4	111,55	SB101350022030	80	30	30	1,32
22	118,4	111,55	SB101350022032	80	32	30	1,29
22	118,4	111,55	SB101350022035	80	35	30	1,26
22	118,4	111,55	SB101350022038	80	38	30	1,23
22	118,4	111,55	SB101350022040	80	40	30	1,19
22	118,4	111,55	SB101350022042	80	42	30	1,17
23	123,5	116,58	SB101350023019	65	19	30	1,25
23	123,5	116,58	SB101350023020	65	20	30	1,22
23	123,5	116,58	SB101350023022	65	22	30	1,20
23	123,5	116,58	SB101350023024	70	24	30	1,27
23	123,5	116,58	SB101350023025	70	25	30	1,25
23	123,5	116,58	SB101350023028	80	28	30	1,36
23	123,5	116,58	SB101350023030	80	30	30	1,39
23	123,5	116,58	SB101350023032	80	32	30	1,36
23	123,5	116,58	SB101350023035	80	35	30	1,33
23	123,5	116,58	SB101350023038	80	38	30	1,30
23	123,5	116,58	SB101350023040	80	40	30	1,26
23	123,5	116,58	SB101350023042	80	42	30	1,20
24	128,5	121,62	SB101350024019	65	19	30	1,30
24	128,5	121,62	SB101350024020	65	20	30	1,28
24	128,5	121,62	SB101350024022	65	22	30	1,25
24	128,5	121,62	SB101350024024	70	24	30	1,34
24	128,5	121,62	SB101350024025	70	25	30	1,33
24	128,5	121,62	SB101350024028	80	28	30	1,48
24	128,5	121,62	SB101350024030	80	30	30	1,45
24	128,5	121,62	SB101350024032	80	32	30	1,42
24	128,5	121,62	SB101350024035	80	35	30	1,40
24	128,5	121,62	SB101350024038	80	38	30	1,35
24	128,5	121,62	SB101350024040	80	40	30	1,33
24	128,5	121,62	SB101350024042	80	42	30	1,30
25	133,6	126,66	SB101350025019	65	19	30	1,37
25	133,6	126,66	SB101350025020	65	20	30	1,35
25	133,6	126,66	SB101350025022	65	22	30	1,32
25	133,6	126,66	SB101350025024	70	24	30	1,41
25	133,6	126,66	SB101350025025	70	25	30	1,39
25	133,6	126,66	SB101350025028	80	28	30	1,56
25	133,6	126,66	SB101350025030	80	30	30	1,53
25	133,6	126,66	SB101350025032	80	32	30	1,50
25	133,6	126,66	SB101350025035	80	35	30	1,47
25	133,6	126,66	SB101350025038	80	38	30	1,43
25	133,6	126,66	SB101350025040	80	40	30	1,40
25	133,6	126,66	SB101350025042	80	42	30	1,38



3/4" x 7/16"
19,05 x 11,68 mm
Rullo 12,07 mm
12B-1

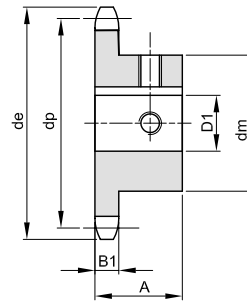
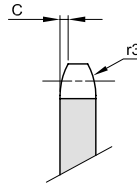

B1	C	r3
11,1	2	19

Materiale: Acciaio C45

Z	de	dp	codice	dm	D1	A	Kg.
10	69,8	61,64	SB101360010019	42	19	30	0,37
10	69,8	61,64	SB101360010020	42	20	30	0,36
10	69,8	61,64	SB101360010024	42	24	30	0,33
10	69,8	61,64	SB101360010025	42	25	30	0,32
11	75,8	67,61	SB101360011019	46	19	35	0,51
11	75,8	67,61	SB101360011020	46	20	35	0,50
11	75,8	67,61	SB101360011024	46	24	35	0,46
11	75,8	67,61	SB101360011025	46	25	35	0,45
12	81,8	73,60	SB101360012019	52	19	35	0,67
12	81,8	73,60	SB101360012020	52	20	35	0,66
12	81,8	73,60	SB101360012022	52	22	35	0,64
12	81,8	73,60	SB101360012024	52	24	35	0,61
12	81,8	73,60	SB101360012025	52	25	35	0,60
12	81,8	73,60	SB101360012028	52	28	35	0,57
12	81,8	73,60	SB101360012030	52	30	35	0,55
12	81,8	73,60	SB101360012032	56	32	35	0,59
12	81,8	73,60	SB101360012035	56	35	35	0,54
13	87,8	79,59	SB101360013019	58	19	35	0,82
13	87,8	79,59	SB101360013020	58	20	35	0,81
13	87,8	79,59	SB101360013022	58	22	35	0,80
13	87,8	79,59	SB101360013024	58	24	35	0,77
13	87,8	79,59	SB101360013025	58	25	35	0,76
13	87,8	79,59	SB101360013028	58	28	35	0,73
13	87,8	79,59	SB101360013030	58	30	35	0,70
13	87,8	79,59	SB101360013032	58	32	35	0,66
13	87,8	79,59	SB101360013035	58	35	35	0,62
13	87,8	79,59	SB101360013038	61	38	35	0,67
14	93,8	85,61	SB101360014019	60	19	35	0,92
14	93,8	85,61	SB101360014020	60	20	35	0,91
14	93,8	85,61	SB101360014022	60	22	35	0,88
14	93,8	85,61	SB101360014024	64	24	35	0,94
14	93,8	85,61	SB101360014025	64	25	35	0,93
14	93,8	85,61	SB101360014028	64	28	35	0,90
14	93,8	85,61	SB101360014030	64	30	35	0,87
14	93,8	85,61	SB101360014032	64	32	35	0,84
14	93,8	85,61	SB101360014035	64	35	35	0,80
14	93,8	85,61	SB101360014038	64	38	35	0,75
14	93,8	85,61	SB101360014040	67	40	35	0,85
15	99,8	91,63	SB101360015019	65	19	35	1,10
15	99,8	91,63	SB101360015020	65	20	35	1,08
15	99,8	91,63	SB101360015022	65	22	35	1,03
15	99,8	91,63	SB101360015024	70	24	35	1,13
15	99,8	91,63	SB101360015025	70	25	35	1,11

Z	de	dp	codice	dm	D1	A	Kg.
15	99,8	91,63	SB101360015028	70	28	35	1,09
15	99,8	91,63	SB101360015030	70	30	35	1,06
15	99,8	91,63	SB101360015032	70	32	35	1,03
15	99,8	91,63	SB101360015035	70	35	35	0,99
15	99,8	91,63	SB101360015038	70	38	35	0,95
15	99,8	91,63	SB101360015040	70	40	35	0,91
16	105,8	97,65	SB101360016019	65	19	35	1,17
16	105,8	97,65	SB101360016020	65	20	35	1,15
16	105,8	97,65	SB101360016022	65	22	35	1,12
16	105,8	97,65	SB101360016024	70	24	35	1,22
16	105,8	97,65	SB101360016025	70	25	35	1,20
16	105,8	97,65	SB101360016028	75	28	35	1,30
16	105,8	97,65	SB101360016030	75	30	35	1,25
16	105,8	97,65	SB101360016032	75	32	35	1,20
16	105,8	97,65	SB101360016035	75	35	35	1,16
16	105,8	97,65	SB101360016038	75	38	35	1,12
16	105,8	97,65	SB101360016040	75	40	35	1,08
17	111,9	103,67	SB101360017025	70	25	35	1,28
17	111,9	103,67	SB101360017028	80	28	35	1,35
17	111,9	103,67	SB101360017030	80	30	35	1,43
17	111,9	103,67	SB101360017032	80	32	35	1,40
17	111,9	103,67	SB101360017035	80	35	35	1,37
17	111,9	103,67	SB101360017038	80	38	35	1,33
17	111,9	103,67	SB101360017040	80	40	35	1,28
17	111,9	103,67	SB101360017042	80	42	35	1,23
18	117,9	109,71	SB101360018025	70	25	35	1,37
18	117,9	109,71	SB101360018028	80	28	35	1,55
18	117,9	109,71	SB101360018030	80	30	35	1,52
18	117,9	109,71	SB101360018032	80	32	35	1,49
18	117,9	109,71	SB101360018035	80	35	35	1,45
18	117,9	109,71	SB101360018038	80	38	35	1,40
18	117,9	109,71	SB101360018040	80	40	35	1,36
18	117,9	109,71	SB101360018042	80	42	35	1,32
19	123,9	115,75	SB101360019025	70	25	35	1,45
19	123,9	115,75	SB101360019028	80	28	35	1,65
19	123,9	115,75	SB101360019030	80	30	35	1,62
19	123,9	115,75	SB101360019032	80	32	35	1,57
19	123,9	115,75	SB101360019035	80	35	35	1,53
19	123,9	115,75	SB101360019038	80	38	35	1,49
19	123,9	115,75	SB101360019040	80	40	35	1,46
19	123,9	115,75	SB101360019042	80	42	35	1,42
19	123,9	115,75	SB101360019045	80	45	35	1,37
19	123,9	115,75	SB101360019048	80	48	35	1,32



PIGNONI SEMPLICI PER CATENE A RULLI "SYSTEM BEA" - DIN 8187 - ISO 606
SIMPLEX SPROCKETS FOR ROLLER CHAINS "SYSTEM BEA" - DIN 8187 - ISO 606

3/4" x 7/16"
19,05 x 11,68 mm
Rullo 12,07 mm
12B-1

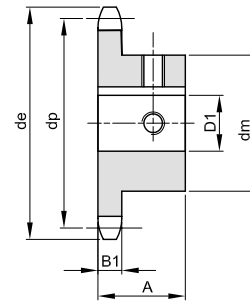
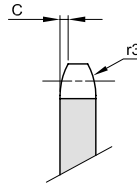

B1	C	r3
11,1	2	19

Materiale: Acciaio C45

Z	de	dp	codice	dm	D1	A	Kg.
19	123,9	115,75	SB101360019050	80	50	35	1,25
20	130,0	121,78	SB101360020025	70	25	35	1,54
20	130,0	121,78	SB101360020028	80	28	35	1,77
20	130,0	121,78	SB101360020030	80	30	35	1,72
20	130,0	121,78	SB101360020032	80	32	35	1,67
20	130,0	121,78	SB101360020035	80	35	35	1,63
20	130,0	121,78	SB101360020038	80	38	35	1,58
20	130,0	121,78	SB101360020040	80	40	35	1,55
20	130,0	121,78	SB101360020042	80	42	35	1,50
20	130,0	121,78	SB101360020045	80	45	35	1,45
20	130,0	121,78	SB101360020048	80	48	35	1,40
20	130,0	121,78	SB101360020050	80	50	35	1,36
21	136,0	127,82	SB101360021025	70	25	40	1,78
21	136,0	127,82	SB101360021028	80	28	40	2,02
21	136,0	127,82	SB101360021030	80	30	40	1,97
21	136,0	127,82	SB101360021032	90	32	40	2,23
21	136,0	127,82	SB101360021035	90	35	40	2,19
21	136,0	127,82	SB101360021038	90	38	40	2,14
21	136,0	127,82	SB101360021040	90	40	40	2,09
21	136,0	127,82	SB101360021042	90	42	40	2,04
21	136,0	127,82	SB101360021045	90	45	40	1,98
21	136,0	127,82	SB101360021048	90	48	40	1,93
21	136,0	127,82	SB101360021050	90	50	40	1,87
22	142,0	133,86	SB101360022025	70	25	40	1,90
22	142,0	133,86	SB101360022028	80	28	40	1,16
22	142,0	133,86	SB101360022030	80	30	40	1,10
22	142,0	133,86	SB101360022032	90	32	40	2,37
22	142,0	133,86	SB101360022035	90	35	40	2,31
22	142,0	133,86	SB101360022038	90	38	40	2,26
22	142,0	133,86	SB101360022040	90	40	40	2,21
22	142,0	133,86	SB101360022042	90	42	40	2,18
22	142,0	133,86	SB101360022045	90	45	40	2,13
22	142,0	133,86	SB101360022048	90	48	40	2,06
22	142,0	133,86	SB101360022050	90	50	40	1,99
23	148,1	139,90	SB101360023025	70	25	40	2,02
23	148,1	139,90	SB101360023028	80	28	40	2,28
23	148,1	139,90	SB101360023030	80	30	40	2,21
23	148,1	139,90	SB101360023032	90	32	40	2,47
23	148,1	139,90	SB101360023035	90	35	40	2,41
23	148,1	139,90	SB101360023038	90	38	40	2,36
23	148,1	139,90	SB101360023040	90	40	40	2,32
23	148,1	139,90	SB101360023042	90	42	40	2,27
23	148,1	139,90	SB101360023045	90	45	40	2,21

Z	de	dp	codice	dm	D1	A	Kg.
23	148,1	139,90	SB101360023048	90	48	40	2,15
23	148,1	139,90	SB101360023050	90	50	40	2,10
24	154,1	145,94	SB101360024025	70	25	40	2,14
24	154,1	145,94	SB101360024028	80	28	40	2,37
24	154,1	145,94	SB101360024030	80	30	40	2,32
24	154,1	145,94	SB101360024032	90	32	40	2,60
24	154,1	145,94	SB101360024035	90	35	40	2,54
24	154,1	145,94	SB101360024038	90	38	40	2,49
24	154,1	145,94	SB101360024040	90	40	40	2,44
24	154,1	145,94	SB101360024042	90	42	40	2,39
24	154,1	145,94	SB101360024045	90	45	40	2,34
24	154,1	145,94	SB101360024048	90	48	40	2,28
24	154,1	145,94	SB101360024050	90	50	40	2,23
25	160,2	152,00	SB101360025025	70	25	40	2,25
25	160,2	152,00	SB101360025028	80	28	40	2,51
25	160,2	152,00	SB101360025030	80	30	40	2,45
25	160,2	152,00	SB101360025032	90	32	40	2,71
25	160,2	152,00	SB101360025035	90	35	40	2,67
25	160,2	152,00	SB101360025038	90	38	40	2,62
25	160,2	152,00	SB101360025040	90	40	40	2,58
25	160,2	152,00	SB101360025042	90	42	40	2,52
25	160,2	152,00	SB101360025045	90	45	40	2,46
25	160,2	152,00	SB101360025048	90	48	40	2,41
25	160,2	152,00	SB101360025050	90	50	40	2,36



1" x 17,02 mm
25,4 x 17,02 mm
Rullo 15,88 mm
16B-1

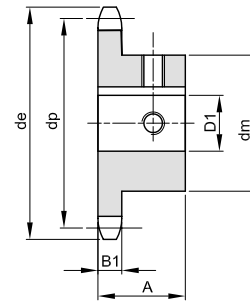
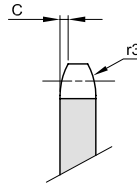

B1	C	r3
16,2	2,5	26

Materiale: Acciaio C45

Z	de	dp	codice	dm	D1	A	Kg.
11	101,7	90,14	SB101380011025	61	25	40	1,12
11	101,7	90,14	SB101380011028	61	28	40	1,09
11	101,7	90,14	SB101380011030	61	30	40	1,06
11	101,7	90,14	SB101380011032	61	32	40	1,02
11	101,7	90,14	SB101380011035	61	35	40	0,98
11	101,7	90,14	SB101380011038	65	38	40	0,97
11	101,7	90,14	SB101380011040	67	40	40	0,99
11	101,7	90,14	SB101380011042	67	42	40	0,97
12	109,7	98,14	SB101380012025	69	25	40	1,42
12	109,7	98,14	SB101380012028	69	28	40	1,39
12	109,7	98,14	SB101380012030	69	30	40	1,35
12	109,7	98,14	SB101380012032	69	32	40	1,31
12	109,7	98,14	SB101380012035	69	35	40	1,27
12	109,7	98,14	SB101380012038	69	38	40	1,22
12	109,7	98,14	SB101380012040	69	40	40	1,17
12	109,7	98,14	SB101380012042	69	42	40	1,13
13	117,7	106,12	SB101380013025	70	25	40	1,59
13	117,7	106,12	SB101380013028	78	28	40	1,61
13	117,7	106,12	SB101380013030	78	30	40	1,63
13	117,7	106,12	SB101380013032	78	32	40	1,62
13	117,7	106,12	SB101380013035	78	35	40	1,61
13	117,7	106,12	SB101380013038	78	38	40	1,56
13	117,7	106,12	SB101380013040	78	40	40	1,51
13	117,7	106,12	SB101380013042	78	42	40	1,48
13	117,7	106,12	SB101380013045	78	45	40	1,45
13	117,7	106,12	SB101380013048	78	48	40	1,41
13	117,7	106,12	SB101380013050	78	50	40	1,37
14	125,7	114,15	SB101380014025	70	25	40	1,83
14	125,7	114,15	SB101380014028	80	28	40	1,95
14	125,7	114,15	SB101380014030	80	30	40	1,92
14	125,7	114,15	SB101380014032	80	32	40	1,89
14	125,7	114,15	SB101380014035	84	35	40	1,91
14	125,7	114,15	SB101380014038	84	38	40	1,86
14	125,7	114,15	SB101380014040	84	40	40	1,83
14	125,7	114,15	SB101380014042	84	42	40	1,75
14	125,7	114,15	SB101380014045	84	45	40	1,71
14	125,7	114,15	SB101380014048	84	48	40	1,66
14	125,7	114,15	SB101380014050	84	50	40	1,61
15	133,7	122,17	SB101380015025	70	25	40	1,94
15	133,7	122,17	SB101380015028	80	28	40	2,12
15	133,7	122,17	SB101380015030	80	30	40	2,09
15	133,7	122,17	SB101380015032	80	32	40	2,03
15	133,7	122,17	SB101380015035	92	35	40	2,30

Z	de	dp	codice	dm	D1	A	Kg.
15	133,7	122,17	SB101380015038	92	38	40	2,25
15	133,7	122,17	SB101380015040	92	40	40	2,21
15	133,7	122,17	SB101380015042	92	42	40	2,15
15	133,7	122,17	SB101380015045	92	45	40	2,08
15	133,7	122,17	SB101380015048	92	48	40	2,03
15	133,7	122,17	SB101380015050	92	50	40	1,99
16	141,8	130,20	SB101380016025	80	25	45	2,59
16	141,8	130,20	SB101380016028	80	28	45	2,50
16	141,8	130,20	SB101380016030	80	30	45	2,47
16	141,8	130,20	SB101380016032	100	32	45	3,09
16	141,8	130,20	SB101380016035	100	35	45	3,01
16	141,8	130,20	SB101380016038	100	38	45	2,94
16	141,8	130,20	SB101380016040	100	40	45	2,89
16	141,8	130,20	SB101380016042	100	42	45	2,84
16	141,8	130,20	SB101380016045	100	45	45	2,78
16	141,8	130,20	SB101380016048	100	48	45	2,70
16	141,8	130,20	SB101380016050	100	50	45	2,65
17	149,8	138,22	SB101380017025	80	25	45	2,75
17	149,8	138,22	SB101380017028	80	28	45	2,70
17	149,8	138,22	SB101380017030	80	30	45	2,67
17	149,8	138,22	SB101380017032	100	32	45	3,30
17	149,8	138,22	SB101380017035	100	35	45	3,21
17	149,8	138,22	SB101380017038	100	38	45	3,15
17	149,8	138,22	SB101380017040	100	40	45	3,09
17	149,8	138,22	SB101380017042	100	42	45	3,02
17	149,8	138,22	SB101380017045	100	45	45	2,97
17	149,8	138,22	SB101380017048	100	48	45	2,91
17	149,8	138,22	SB101380017050	100	50	45	2,84
18	157,8	146,28	SB101380018025	80	25	45	2,97
18	157,8	146,28	SB101380018028	80	28	45	2,92
18	157,8	146,28	SB101380018030	80	30	45	2,89
18	157,8	146,28	SB101380018032	100	32	45	3,47
18	157,8	146,28	SB101380018035	100	35	45	3,42
18	157,8	146,28	SB101380018038	100	38	45	3,37
18	157,8	146,28	SB101380018040	100	40	45	3,32
18	157,8	146,28	SB101380018042	100	42	45	3,25
18	157,8	146,28	SB101380018045	100	45	45	3,19
18	157,8	146,28	SB101380018048	100	48	45	3,12
18	157,8	146,28	SB101380018050	100	50	45	3,06
19	165,9	154,33	SB101380019025	80	25	45	3,21
19	165,9	154,33	SB101380019028	80	28	45	3,18
19	165,9	154,33	SB101380019030	80	30	45	3,12
19	165,9	154,33	SB101380019032	100	32	45	3,71



1" x 17,02 mm
25,4 x 17,02 mm
Rullo 15,88 mm
16B-1

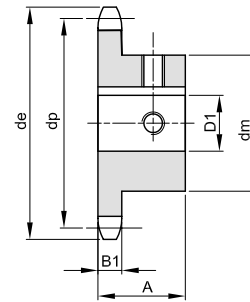
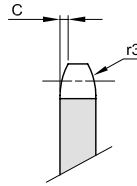

B1	C	r3
16,2	2,5	26

Materiale: Acciaio C45

Z	de	dp	codice	dm	D1	A	Kg.
19	165,9	154,33	SB101380019035	100	35	45	3,67
19	165,9	154,33	SB101380019038	100	38	45	3,61
19	165,9	154,33	SB101380019040	100	40	45	3,56
19	165,9	154,33	SB101380019042	100	42	45	3,51
19	165,9	154,33	SB101380019045	100	45	45	3,46
19	165,9	154,33	SB101380019048	100	48	45	3,38
19	165,9	154,33	SB101380019050	100	50	45	3,30
20	173,9	162,38	SB101380020025	80	25	45	3,46
20	173,9	162,38	SB101380020028	80	28	45	3,41
20	173,9	162,38	SB101380020030	80	30	45	3,37
20	173,9	162,38	SB101380020032	100	32	45	3,95
20	173,9	162,38	SB101380020035	100	35	45	3,90
20	173,9	162,38	SB101380020038	100	38	45	3,84
20	173,9	162,38	SB101380020040	100	40	45	3,79
20	173,9	162,38	SB101380020042	100	42	45	3,72
20	173,9	162,38	SB101380020045	100	45	45	3,65
20	173,9	162,38	SB101380020048	100	48	45	3,60
20	173,9	162,38	SB101380020050	100	50	45	3,55
21	182,0	170,43	SB101380021025	80	25	50	3,92
21	182,0	170,43	SB101380021028	80	28	50	3,86
21	182,0	170,43	SB101380021030	80	30	50	3,81
21	182,0	170,43	SB101380021032	100	32	50	4,52
21	182,0	170,43	SB101380021035	100	35	50	4,45
21	182,0	170,43	SB101380021038	100	38	50	4,38
21	182,0	170,43	SB101380021040	110	40	50	4,75
21	182,0	170,43	SB101380021042	110	42	50	4,70
21	182,0	170,43	SB101380021045	110	45	50	4,63
21	182,0	170,43	SB101380021048	110	48	50	4,54
21	182,0	170,43	SB101380021050	110	50	50	4,48
22	190,1	178,48	SB101380022025	80	25	50	4,19
22	190,1	178,48	SB101380022028	80	28	50	4,13
22	190,1	178,48	SB101380022030	80	30	50	4,08
22	190,1	178,48	SB101380022032	100	32	50	4,79
22	190,1	178,48	SB101380022035	100	35	50	4,72
22	190,1	178,48	SB101380022038	100	38	50	4,66
22	190,1	178,48	SB101380022040	110	40	50	5,04
22	190,1	178,48	SB101380022042	110	42	50	5,00
22	190,1	178,48	SB101380022045	110	45	50	4,94
22	190,1	178,48	SB101380022048	110	48	50	4,88
22	190,1	178,48	SB101380022050	110	50	50	4,82
23	198,1	186,53	SB101380023025	80	25	50	4,48
23	198,1	186,53	SB101380023028	80	28	50	4,42
23	198,1	186,53	SB101380023030	80	30	50	4,35

Z	de	dp	codice	dm	D1	A	Kg.
23	198,1	186,53	SB101380023032	100	32	50	5,08
23	198,1	186,53	SB101380023035	100	35	50	5,01
23	198,1	186,53	SB101380023038	100	38	50	4,93
23	198,1	186,53	SB101380023040	110	40	50	5,32
23	198,1	186,53	SB101380023042	110	42	50	5,28
23	198,1	186,53	SB101380023045	110	45	50	5,22
23	198,1	186,53	SB101380023048	110	48	50	5,17
23	198,1	186,53	SB101380023050	110	50	50	5,11
24	206,2	194,59	SB101380024025	80	25	50	4,79
24	206,2	194,59	SB101380024028	80	28	50	4,73
24	206,2	194,59	SB101380024030	80	30	50	4,68
24	206,2	194,59	SB101380024032	100	32	50	5,37
24	206,2	194,59	SB101380024035	100	35	50	5,31
24	206,2	194,59	SB101380024038	100	38	50	5,26
24	206,2	194,59	SB101380024040	110	40	50	5,63
24	206,2	194,59	SB101380024042	110	42	50	5,54
24	206,2	194,59	SB101380024045	110	45	50	5,46
24	206,2	194,59	SB101380024048	110	48	50	5,39
24	206,2	194,59	SB101380024050	110	50	50	5,32
25	214,2	202,66	SB101380025025	80	25	50	5,11
25	214,2	202,66	SB101380025028	80	28	50	5,04
25	214,2	202,66	SB101380025030	80	30	50	4,97
25	214,2	202,66	SB101380025032	100	32	50	5,67
25	214,2	202,66	SB101380025035	100	35	50	5,60
25	214,2	202,66	SB101380025038	100	38	50	5,53
25	214,2	202,66	SB101380025040	110	40	50	5,92
25	214,2	202,66	SB101380025042	110	42	50	5,84
25	214,2	202,66	SB101380025045	110	45	50	5,77
25	214,2	202,66	SB101380025048	110	48	50	5,70
25	214,2	202,66	SB101380025050	110	50	50	5,64



PIGNONI DOPPI PER CATENE A RULLI "SYSTEM BEA" - DIN 8187 - ISO 606
DUPLEX SPROCKETS FOR ROLLER CHAINS "SYSTEM BEA" - DIN 8187 - ISO 606

3/8" x 7/32"
9,525 x 5,72 mm
Rullo 6,35 mm
06B-2

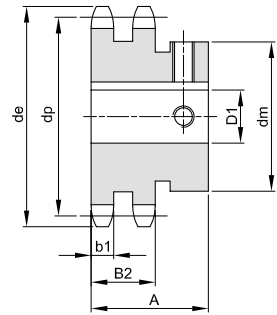
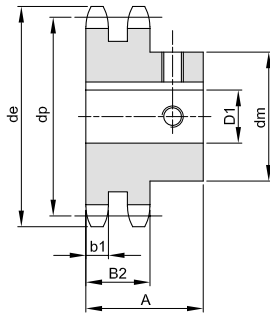
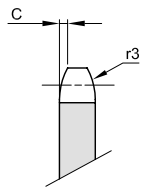

TIPO *

B1	B2	B3	b1	C	r3
15,4	5,2	1	10		

Materiale: Acciaio C45

Z	de	dp	codice	dm	D1	A	Kg.
11	37,5	33,80	SB102330011010	24	10	35	0,12
11	37,5	33,80	SB102330011012	26*	12	35	0,12
11	37,5	33,80	SB102330011014	29*	14	35	0,12
11	37,5	33,80	SB102330011015	30*	15	35	0,12
12	40,5	36,80	SB102330012010	25	10	35	0,14
12	40,5	36,80	SB102330012012	26	12	35	0,14
12	40,5	36,80	SB102330012014	29*	14	35	0,14
12	40,5	36,80	SB102330012015	30*	15	35	0,14
12	40,5	36,80	SB102330012016	31*	16	35	0,14
13	43,5	39,80	SB102330013010	28	10	35	0,18
13	43,5	39,80	SB102330013012	28	12	35	0,17
13	43,5	39,80	SB102330013014	29	14	35	0,17
13	43,5	39,80	SB102330013015	30	15	35	0,17
14	46,5	42,80	SB102330014014	31	14	35	0,20
14	46,5	42,80	SB102330014015	31	15	35	0,20
14	46,5	42,80	SB102330014016	31	16	35	0,19
14	46,5	42,80	SB102330014019	35*	19	35	0,19
15	49,5	45,81	SB102330015014	34	14	35	0,25
15	49,5	45,81	SB102330015015	34	15	35	0,24
15	49,5	45,81	SB102330015016	34	16	35	0,24
15	49,5	45,81	SB102330015020	36	20	35	0,22
15	49,5	45,81	SB102330015025	42*	25	35	0,20
16	52,5	48,82	SB102330016012	37	12	38	0,33
16	52,5	48,82	SB102330016015	37	15	38	0,31
16	52,5	48,82	SB102330016020	37	20	38	0,27
16	52,5	48,82	SB102330016025	42*	25	38	0,25
17	55,5	51,83	SB102330017012	40	12	38	0,39
17	55,5	51,83	SB102330017015	40	15	38	0,37
17	55,5	51,83	SB102330017020	40	20	38	0,33
17	55,5	51,83	SB102330017025	42	25	38	0,29
18	58,6	54,85	SB102330018012	43	12	38	0,45
18	58,6	54,85	SB102330018015	43	15	38	0,43
18	58,6	54,85	SB102330018020	43	20	38	0,39
18	58,6	54,85	SB102330018025	43	25	38	0,33
19	61,6	57,87	SB102330019012	45	12	38	0,50
19	61,6	57,87	SB102330019015	45	15	38	0,48
19	61,6	57,87	SB102330019016	45	16	38	0,48
19	61,6	57,87	SB102330019020	45	20	38	0,44
19	61,6	57,87	SB102330019025	45	25	38	0,38
20	64,6	60,89	SB102330020012	46	12	38	0,55
20	64,6	60,89	SB102330020015	46	15	38	0,53
20	64,6	60,89	SB102330020016	46	16	38	0,52
20	64,6	60,89	SB102330020020	46	20	38	0,48

Z	de	dp	codice	dm	D1	A	Kg.
20	64,6	60,89	SB102330020025	46	25	38	0,43
21	67,6	63,91	SB102330021015	48	15	38	0,59
21	67,6	63,91	SB102330021016	48	16	38	0,58
21	67,6	63,91	SB102330021020	48	20	38	0,54
21	67,6	63,91	SB102330021025	48	25	38	0,49
22	70,6	66,93	SB102330022020	50	20	38	0,60
22	70,6	66,93	SB102330022025	50	25	38	0,55
23	73,7	69,95	SB102330023015	52	15	38	0,71
23	73,7	69,95	SB102330023016	52	16	38	0,70
23	73,7	69,95	SB102330023020	52	20	38	0,67
23	73,7	69,95	SB102330023025	52	25	38	0,61
24	76,7	72,97	SB102330024020	54	20	38	0,73
24	76,7	72,97	SB102330024025	54	25	38	0,68
25	79,7	76,00	SB102330025016	57	16	38	0,86
25	79,7	76,00	SB102330025020	57	20	38	0,82
25	79,7	76,00	SB102330025025	57	25	38	0,76
25	79,7	76,00	SB102330025030	57	30	38	0,70
30	94,8	91,12	SB102330030020	60	20	40	1,13
30	94,8	91,12	SB102330030025	60	25	40	1,07
30	94,8	91,12	SB102330030030	60	30	40	1,01



PIGNONI DOPPI PER CATENE A RULLI "SYSTEM BEA" - DIN 8187 - ISO 606

DUPLEX SPROCKETS FOR ROLLER CHAINS "SYSTEM BEA" - DIN 8187 - ISO 606

5/8" x 3/8"
15,875 x 9,65 mm
 Rullo 10,16 mm
10B-2

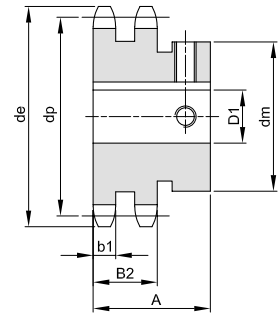
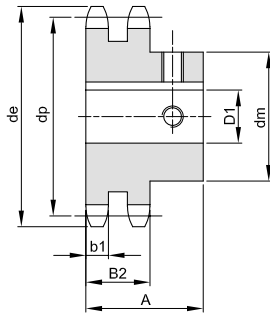
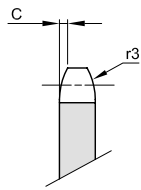

TIPO *

B1	B2	B3	b1	C	r3
25,5			9	1,6	16

Materiale: Acciaio C45

Z	de	dp	codice	dm	D1	A	Kg.
11	63,2	56,34	SB102350011020	37	20	45	0,43
11	63,2	56,34	SB102350011025	42*	25	45	0,40
11	63,2	56,34	SB102350011030	45*	30	45	0,35
12	68,2	61,34	SB102350012020	42	20	45	0,56
12	68,2	61,34	SB102350012025	44	25	45	0,51
12	68,2	61,34	SB102350012030	49*	30	45	0,47
13	73,2	66,32	SB102350013020	47	20	45	0,70
13	73,2	66,32	SB102350013025	47	25	45	0,63
13	73,2	66,32	SB102350013030	49	30	45	0,58
14	78,2	71,34	SB102350014020	52	20	45	0,85
14	78,2	71,34	SB102350014025	52	25	45	0,78
14	78,2	71,34	SB102350014030	52	30	45	0,71
15	83,2	76,36	SB102350015020	57	20	45	1,02
15	83,2	76,36	SB102350015025	57	25	45	0,95
15	83,2	76,36	SB102350015030	57	30	45	0,88
15	83,2	76,36	SB102350015035	57	35	45	0,78
16	88,3	81,37	SB102350016020	60	20	45	1,17
16	88,3	81,37	SB102350016025	60	25	45	1,11
16	88,3	81,37	SB102350016030	60	30	45	1,03
16	88,3	81,37	SB102350016035	60	35	45	0,94
17	93,3	86,39	SB102350017020	60	20	45	1,29
17	93,3	86,39	SB102350017025	60	25	45	1,23
17	93,3	86,39	SB102350017030	60	30	45	1,15
17	93,3	86,39	SB102350017035	60	35	45	1,06
18	98,3	91,42	SB102350018020	70	20	45	1,58
18	98,3	91,42	SB102350018025	70	25	45	1,51
18	98,3	91,42	SB102350018030	70	30	45	1,44
18	98,3	91,42	SB102350018035	70	35	45	1,34
18	98,3	91,42	SB102350018040	70	40	45	1,23
19	103,3	96,45	SB102350019020	70	20	45	1,71
19	103,3	96,45	SB102350019025	70	25	45	1,65
19	103,3	96,45	SB102350019030	70	30	45	1,57
19	103,3	96,45	SB102350019035	70	35	45	1,48
19	103,3	96,45	SB102350019040	70	40	45	1,37
20	108,4	101,49	SB102350020020	75	20	45	1,94
20	108,4	101,49	SB102350020025	75	25	45	1,88
20	108,4	101,49	SB102350020030	75	30	45	1,80
20	108,4	101,49	SB102350020035	75	35	45	1,71
20	108,4	101,49	SB102350020040	75	40	45	1,60
21	113,4	106,52	SB102350021020	75	20	45	2,10
21	113,4	106,52	SB102350021025	75	25	45	2,03
21	113,4	106,52	SB102350021030	75	30	45	1,95
21	113,4	106,52	SB102350021035	75	35	45	1,86

Z	de	dp	codice	dm	D1	A	Kg.
21	113,4	106,52	SB102350021040	75	40	45	1,75
22	118,4	111,55	SB102350022020	80	20	45	2,35
22	118,4	111,55	SB102350022025	80	25	45	2,28
22	118,4	111,55	SB102350022030	80	30	45	2,21
23	123,5	116,58	SB102350023020	80	20	45	2,52
23	123,5	116,58	SB102350023025	80	25	45	2,45
23	123,5	116,58	SB102350023030	80	30	45	2,37
23	123,5	116,58	SB102350023035	80	35	45	2,28
23	123,5	116,58	SB102350023040	80	40	45	2,17
24	128,5	121,62	SB102350024020	80	20	45	2,69
24	128,5	121,62	SB102350024025	80	25	45	2,63
24	128,5	121,62	SB102350024030	80	30	45	2,55
25	133,6	126,66	SB102350025025	80	25	45	2,81
25	133,6	126,66	SB102350025030	80	30	45	2,74
25	133,6	126,66	SB102350025035	80	35	45	2,64
25	133,6	126,66	SB102350025040	80	40	45	2,53



PIGNONI DOPPI PER CATENE A RULLI "SYSTEM BEA" - DIN 8187 - ISO 606
DUPLEX SPROCKETS FOR ROLLER CHAINS "SYSTEM BEA" - DIN 8187 - ISO 606

3/4" x 7/16"
19,05 x 11,68 mm
Rullo 12,07 mm
12B-2

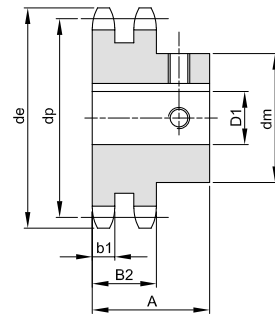
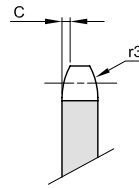

B1	B2	B3	b1	C	r3
30,3	10,8	2	19		

Materiale: Acciaio C45

Z	de	dp	codice	dm	D1	A	Kg.
11	75,8	67,61	SB102360011020	46	20	54	0,82
11	75,8	67,61	SB102360011025	46	25	54	0,74
11	75,8	67,61	SB102360011030	51	30	54	0,72
12	81,8	73,60	SB102360012020	52	20	54	1,04
12	81,8	73,60	SB102360012025	52	25	54	0,96
12	81,8	73,60	SB102360012030	52	30	54	0,87
12	81,8	73,60	SB102360012035	56	35	54	0,82
13	87,8	79,59	SB102360013020	58	20	54	1,28
13	87,8	79,59	SB102360013025	58	25	54	1,20
13	87,8	79,59	SB102360013030	58	30	54	1,11
13	87,8	79,59	SB102360013035	58	35	54	1,00
14	93,8	85,61	SB102360014020	64	20	54	1,56
14	93,8	85,61	SB102360014025	64	25	54	1,47
14	93,8	85,61	SB102360014030	64	30	54	1,38
14	93,8	85,61	SB102360014035	64	35	54	1,27
15	99,8	91,63	SB102360015020	70	20	54	1,85
15	99,8	91,63	SB102360015025	70	25	54	1,77
15	99,8	91,63	SB102360015030	70	30	54	1,68
15	99,8	91,63	SB102360015035	70	35	54	1,57
16	105,8	97,65	SB102360016025	75	25	54	2,07
16	105,8	97,65	SB102360016030	75	30	54	1,98
16	105,8	97,65	SB102360016035	75	35	54	1,87
16	105,8	97,65	SB102360016040	75	40	54	1,73
17	111,9	103,67	SB102360017025	80	25	54	2,39
17	111,9	103,67	SB102360017030	80	30	54	2,30
17	111,9	103,67	SB102360017035	80	35	54	2,18
17	111,9	103,67	SB102360017040	80	40	54	2,05
18	117,9	109,71	SB102360018025	80	25	54	2,61
18	117,9	109,71	SB102360018030	80	30	54	2,52
18	117,9	109,71	SB102360018035	80	35	54	2,40
18	117,9	109,71	SB102360018040	80	40	54	2,27
19	123,9	115,75	SB102360019025	80	25	54	2,84
19	123,9	115,75	SB102360019030	80	30	54	2,75
19	123,9	115,75	SB102360019035	80	35	54	2,64
19	123,9	115,75	SB102360019040	80	40	54	2,51
20	130,0	121,78	SB102360020025	80	25	54	3,09
20	130,0	121,78	SB102360020030	80	30	54	3,00
20	130,0	121,78	SB102360020035	80	35	54	2,88
20	130,0	121,78	SB102360020040	80	40	54	2,75
21	136,0	127,82	SB102360021025	90	25	59	3,82
21	136,0	127,82	SB102360021030	90	30	59	3,72
21	136,0	127,82	SB102360021035	90	35	59	3,59
21	136,0	127,82	SB102360021040	90	40	59	3,45

Z	de	dp	codice	dm	D1	A	Kg.
21	136,0	127,82	SB102360021045	90	45	59	3,29
22	142,0	133,86	SB102360022025	90	25	59	4,09
22	142,0	133,86	SB102360022030	90	30	59	3,99
22	142,0	133,86	SB102360022035	90	35	59	3,87
22	142,0	133,86	SB102360022040	90	40	59	3,72
23	148,1	139,90	SB102360023025	90	25	59	4,38
23	148,1	139,90	SB102360023030	90	30	59	4,29
23	148,1	139,90	SB102360023035	90	35	59	4,16
23	148,1	139,90	SB102360023040	90	40	59	4,02
23	148,1	139,90	SB102360023045	90	45	59	3,85
24	154,1	145,94	SB102360024025	90	25	59	4,68
24	154,1	145,94	SB102360024030	90	30	59	4,59
24	154,1	145,94	SB102360024035	90	35	59	4,46
24	154,1	145,94	SB102360024040	90	40	59	4,32
25	160,2	152,00	SB102360025025	90	25	59	5,00
25	160,2	152,00	SB102360025030	90	30	59	4,90
25	160,2	152,00	SB102360025035	90	35	59	4,77
25	160,2	152,00	SB102360025040	90	40	59	4,63



DATI TECNICI - TECHNICAL DATA

Temperati ad induzione sui denti (HRc 50)
Diametro fori in tolleranza H7 - Rugosità RA 1,6
Cave Linguette secondo DIN 6885 / UNI 6604 in asse al dente
N° 2 fori per viti di fissaggio

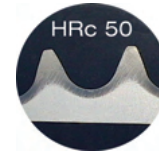

Teeth: inductioned hardness (HRc 50)
 Final bore tolerance H7 - Roughness value RA 1,6
 Keyway to DIN 6885 / BS 4235 is located on the center line of tooth
 Two grub screw holes

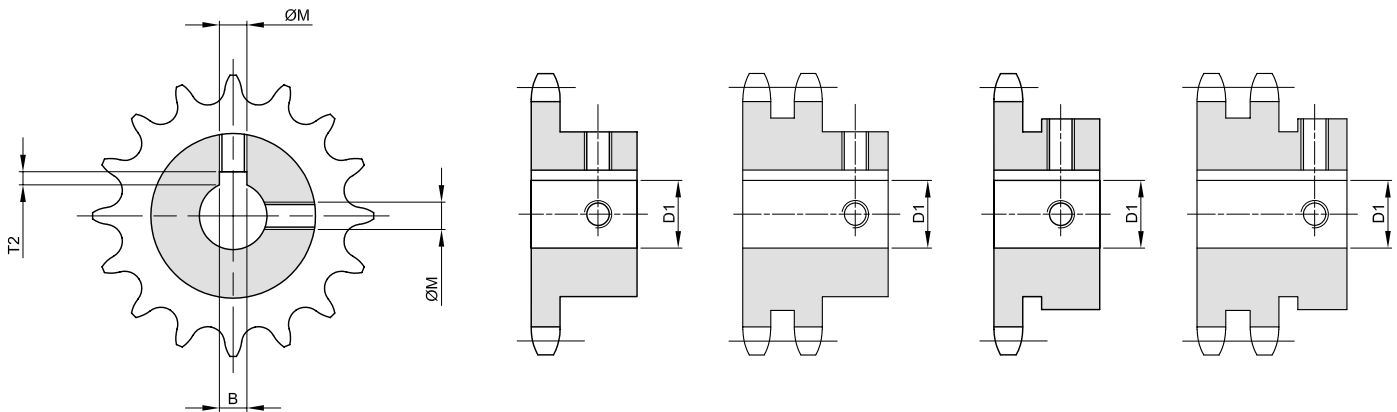

diametro fori D1		larghezza cava B		profondità cava T2		diametro vite Ø M
Ø10	H7 +0,015 -0	3	H9 +0,025 -0	1,4	+0,10 -0	M3
Ø12	H7 +0,018 -0	4	H9 +0,030 -0	1,8	+0,10 -0	M3
Ø14	H7 +0,018 -0	5	H9 +0,030 -0	2,3	+0,10 -0	M4
Ø15	H7 +0,018 -0	5	H9 +0,030 -0	2,3	+0,10 -0	M4
Ø16	H7 +0,018 -0	5	H9 +0,030 -0	2,3	+0,10 -0	M4
Ø18	H7 +0,018 -0	6	H9 +0,030 -0	2,8	+0,10 -0	M5
Ø19	H7 +0,021 -0	6	H9 +0,030 -0	2,8	+0,10 -0	M5
Ø20	H7 +0,021 -0	6	H9 +0,030 -0	2,8	+0,10 -0	M5
Ø22	H7 +0,021 -0	6	H9 +0,030 -0	2,8	+0,10 -0	M5
Ø24	H7 +0,021 -0	8	H9 +0,036 -0	3,3	+0,20 -0	M6
Ø25	H7 +0,021 -0	8	H9 +0,036 -0	3,3	+0,20 -0	M6
Ø28	H7 +0,021 -0	8	H9 +0,036 -0	3,3	+0,20 -0	M6
Ø30	H7 +0,021 -0	8	H9 +0,036 -0	3,3	+0,20 -0	M6
Ø32	H7 +0,025 -0	10	H9 +0,036 -0	3,3	+0,20 -0	M8
Ø35	H7 +0,025 -0	10	H9 +0,036 -0	3,3	+0,20 -0	M8
Ø38	H7 +0,025 -0	10	H9 +0,036 -0	3,3	+0,20 -0	M8
Ø40	H7 +0,025 -0	12	H9 +0,043 -0	3,3	+0,20 -0	M10
Ø42	H7 +0,025 -0	12	H9 +0,043 -0	3,3	+0,20 -0	M10
Ø45	H7 +0,025 -0	14	H9 +0,043 -0	3,8	+0,20 -0	M12
Ø48	H7 +0,025 -0	14	H9 +0,043 -0	3,8	+0,20 -0	M12
Ø50	H7 +0,025 -0	14	H9 +0,043 -0	3,8	+0,20 -0	M12





PIGNONI PER CATENE A RULLI - DIN 8187 - ISO 606

SPROCKETS FOR ROLLER CHAINS - DIN 8187 - ISO 606

6 x 2,8 mm

Rullo 4 mm

04 - 1

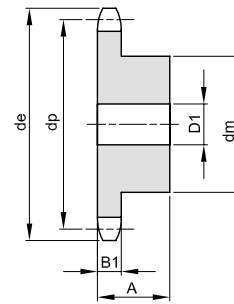
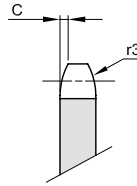

B1	B2	B3	b1	C	r3
2,6				0,6	6

Materiale: Acciaio C45 / *Materiale: Fe - con mozzo saldato

Z	de	dp	semplici					doppi				tripli						
			codice	dm	D1	A	Kg.	codice	dm	D2	A	Kg.	codice	dm	D3	A	Kg.	
8	18,0	15,67	101306008	9,8	5	10	0,01											
9	19,9	17,54	101306009	11,5	5	10	0,01											
10	21,7	19,42	101306010	13	6	10	0,01											
11	23,6	21,30	101306011	14	6	10	0,01											
12	25,4	23,18	101306012	16	6	10	0,02											
13	27,3	25,05	101306013	18	6	10	0,02											
14	29,2	26,96	101306014	20	6	10	0,03											
15	31,1	28,86	101306015	20	6	10	0,03											
16	33,0	30,76	101306016	20	8	13	0,03											
17	35,0	32,65	101306017	20	8	13	0,04											
18	36,9	34,55	101306018	20	8	13	0,04											
19	38,8	36,44	101306019	20	8	13	0,04											
20	40,7	38,34	101306020	20	8	13	0,04											
21	42,6	40,25	101306021	25	8	13	0,06											
22	44,5	42,16	101306022	25	8	13	0,06											
23	46,4	44,06	101306023	25	8	13	0,06											
24	48,3	45,96	101306024	25	8	13	0,07											
25	50,2	47,87	101306025	25	8	13	0,07											
26	52,1	49,77	101306026	30	8	15	0,10											
27	54,0	51,67	101306027	30	8	15	0,10											
28	55,9	53,58	101306028	30	8	15	0,11											
29	57,8	55,50	101306029	30	8	15	0,11											
30	59,8	57,42	101306030	30	8	15	0,11											
31	61,7	59,31	101306031	30	10	15	0,11											
32	63,6	61,21	101306032	30	10	15	0,12											
33	65,5	63,11	101306033	30	10	15	0,12											
34	67,4	65,02	101306034	30	10	15	0,12											
35	69,3	66,93	101306035	30	10	15	0,13											
36	71,2	68,84	101306036	30	10	15	0,13											
37	73,1	70,75	101306037	30	10	15	0,14											
38	75,0	72,66	101306038	30	10	15	0,14											
39	76,9	74,56	101306039	30	10	15	0,14											
40	78,9	76,47	101306040	30	10	15	0,15											
45	88,5	86,01	101306045	62	12	18	0,46											
48	94,2	91,74	101306048	62	12	18	0,48											
50	98,0	95,55	101306050	62	12	18	0,49											
57	111,4	108,93	101306057	62	12	18	0,53											
60	117,5	114,62	101306060	*62	12	20	0,68											
76	148,1	145,19	101306076	*80	16	34	1,58											



PIGNONI PER CATENE A RULLI - DIN 8187 - ISO 606

SPROCKETS FOR ROLLER CHAINS - DIN 8187 - ISO 606

8 x 3,0 mm

Rullo 5 mm

05B - 1 - 2

B1	B2	B3	b1	C	r3
2,8	8,3		2,7	0,8	8

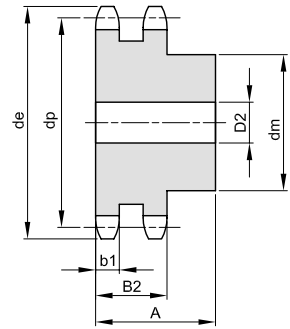
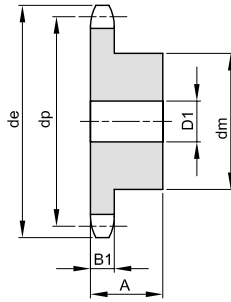
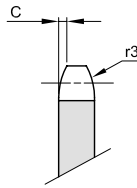

Materiale: Acciaio C45 / *Materiale: Fe - con mozzo saldato

Z	de	dp	semplici					doppi				tripli						
			codice	dm	D1	A	Kg.	codice	dm	D2	A	Kg.	codice	dm	D3	A	Kg.	
8	23,4	20,90	101308008	13	6	12	0,01	102308008	12	6	18	0,02						
9	25,9	23,39	101308009	15	6	12	0,02	102308009	15	6	18	0,03						
10	28,4	25,89	101308010	17	6	12	0,02	102308010	17	8	18	0,03						
11	31,0	28,39	101308011	18	7	13	0,03	102308011	19	8	18	0,04						
12	33,7	30,91	101308012	20	7	13	0,04	102308012	21	8	18	0,05						
13	36,7	33,42	101308013	23	7	13	0,05	102308013	24	8	18	0,07						
14	39,2	35,95	101308014	25	7	13	0,05	102308014	26	8	18	0,08						
15	41,7	38,48	101308015	28	7	13	0,07	102308015	29	8	18	0,10						
16	44,2	41,01	101308016	30	8	14	0,08	102308016	32	10	20	0,13						
17	46,7	43,53	101308017	30	8	14	0,09	102308017	34	10	20	0,15						
18	49,2	46,07	101308018	30	8	14	0,09	102308018	37	10	20	0,17						
19	51,7	48,61	101308019	30	8	14	0,09	102308019	39	10	20	0,20						
20	54,2	51,14	101308020	30	8	14	0,10	102308020	40	10	20	0,21						
21	57,2	53,67	101308021	35	8	14	0,12	102308021	45	12	20	0,25						
22	59,4	56,21	101308022	35	8	14	0,13	102308022	45	12	20	0,26						
23	62,2	58,75	101308023	35	8	14	0,13	102308023	45	12	20	0,28						
24	64,7	61,29	101308024	35	8	14	0,14	102308024	45	12	20	0,23						
25	67,2	63,83	101308025	35	8	14	0,15	102308025	45	12	20	0,31						
26	69,7	66,37	101308026	40	10	16	0,19	102308026	50	12	22	0,38						
27	72,3	68,91	101308027	40	10	16	0,20	102308027	50	12	22	0,40						
28	74,7	71,45	101308028	40	10	16	0,20											
29	77,2	73,99	101308029	40	10	16	0,21											
30	80,2	76,53	101308030	40	10	16	0,22	102308030	50	12	22	0,45						
31	82,7	79,08	101308031	40	12	16	0,22											
32	85,2	81,61	101308032	40	12	16	0,22	102308032	60	12	22	0,59						
33	87,7	84,16	101308033	40	12	16	0,23											
34	90,2	86,70	101308034	40	12	16	0,24											
35	92,7	89,24	101308035	40	12	16	0,25	102308035	60	12	22	0,65						
36	95,2	91,79	101308036	40	12	16	0,25	102308036	60	12	22	0,67						
37	97,7	94,33	101308037	40	12	16	0,26											
38	100,2	96,88	101308038	40	12	16	0,27	102308038	60	12	22	0,72						
39	102,7	99,42	101308039	40	12	16	0,28											
40	105,7	101,97	101308040	40	12	16	0,29	102308040	60	12	22	0,77						
45	118,6	114,69	101308045	60	12	20	0,58											
48	125,5	122,32	101308048	*62	12	20	0,67											
50	131,5	127,41	101308050	*62	12	20	0,63											
57	149,3	145,22	101308057	*80	14	20	1,00											
60	156,0	152,85	101308060	*80	16	34	1,53											
76	196,7	193,59	101308076	*80	20	34	1,94											



PIGNONI PER CATENE A RULLI - DIN 8187 - ISO 606

SPROCKETS FOR ROLLER CHAINS - DIN 8187 - ISO 606

3/8" x 7/32"
9,525 x 5,72 mm
Rullo 6,35 mm
06B - 1 - 2 - 3

B1	B2	B3	b1	C	r3
5,3	15,4	25,6	5,2	1	10

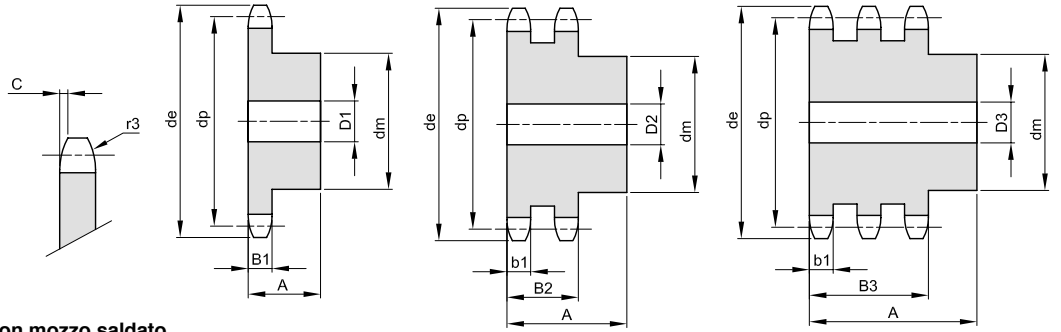

Materiale: Acciaio C45 / *Materiale: Fe - con mozzo saldato

Z	de	dp	semplici					doppi					tripli				
			codice	dm	D1	A	Kg.	codice	dm	D2	A	Kg.	codice	dm	D3	A	Kg.
8	28,6	24,89	101330008	15	8	20	0,03	102330008	15	8	25	0,04	103330008	15	8	32	0,05
9	31,5	27,85	101330009	18	8	20	0,04	102330009	18	8	25	0,05	103330009	18	8	32	0,07
10	34,5	30,82	101330010	20	8	20	0,05	102330010	20	8	25	0,07	103330010	20	10	32	0,09
11	37,5	33,80	101330011	22	8	25	0,08	102330011	22	10	30	0,10	103330011	22	12	35	0,11
12	40,5	36,80	101330012	25	8	25	0,10	102330012	25	10	30	0,13	103330012	25	12	35	0,15
13	43,5	39,80	101330013	28	8	25	0,13	102330013	28	10	30	0,16	103330013	28	12	35	0,19
14	46,5	42,80	101330014	31	8	25	0,16	102330014	31	10	30	0,20	103330014	31	12	35	0,23
15	49,5	45,81	101330015	34	8	25	0,19	102330015	34	10	30	0,24	103330015	34	12	35	0,28
16	52,5	48,82	101330016	37	10	28	0,24	102330016	37	12	30	0,27	103330016	37	12	35	0,33
17	55,5	51,83	101330017	40	10	28	0,28	102330017	40	12	30	0,32	103330017	40	12	35	0,39
18	58,6	54,85	101330018	43	10	28	0,33	102330018	43	12	30	0,38	103330018	43	12	35	0,45
19	61,6	57,87	101330019	45	10	28	0,36	102330019	46	12	30	0,42	103330019	46	12	35	0,51
20	64,6	60,89	101330020	46	10	28	0,39	102330020	49	12	30	0,48	103330020	49	12	35	0,58
21	67,6	63,91	101330021	48	12	28	0,42	102330021	52	16	30	0,52	103330021	52	16	40	0,70
22	70,6	66,93	101330022	50	12	28	0,46	102330022	55	16	30	0,58	103330022	55	16	40	0,78
23	73,7	69,95	101330023	52	12	28	0,50	102330023	58	16	30	0,64	103330023	58	16	40	0,87
24	76,7	72,97	101330024	54	12	28	0,54	102330024	61	16	30	0,71	103330024	61	16	40	0,97
25	79,7	76,00	101330025	57	12	28	0,60	102330025	64	16	30	0,79	103330025	64	16	40	1,06
26	82,7	79,02	101330026	60	12	28	0,66	102330026	67	16	30	0,87	103330026	67	16	40	1,17
27	85,7	82,04	101330027	60	12	28	0,67	102330027	70	16	30	0,94	103330027	70	16	40	1,27
28	88,8	85,07	101330028	60	12	28	0,69	102330028	73	16	30	1,03	103330028	73	16	40	1,39
29	91,8	88,09	101330029	60	12	28	0,70	102330029	76	16	30	1,11	103330029	76	16	40	1,50
30	94,8	91,12	101330030	60	12	30	0,72	102330030	79	16	30	1,20	103330030	79	16	40	1,62
31	97,9	94,15	101330031	65	14	30	0,87	102330031	80	16	30	1,27	103330031	80	16	40	1,72
32	100,9	97,17	101330032	65	14	30	0,89	102330032	80	16	30	1,32	103330032	80	16	40	1,80
33	103,9	100,20	101330033	65	14	30	0,91	102330033	80	16	30	1,37	103330033	80	16	40	1,89
34	106,9	103,23	101330034	65	14	30	0,92	102330034	80	16	30	1,43	103330034	85	16	40	2,06
35	110,0	106,26	101330035	65	14	30	0,95	102330035	80	16	30	1,49	103330035	85	16	40	2,15
36	113,0	109,29	101330036	70	16	30	1,05	102330036	90	16	30	1,70	103330036	90	16	40	2,33
37	116,0	112,32	101330037	70	16	30	1,09	102330037	90	16	30	1,76	103330037	90	16	40	2,43
38	119,0	115,34	101330038	70	16	30	1,10	102330038	90	16	30	1,81	103330038	90	16	40	2,53
39	122,1	118,37	101330039	70	16	30	1,12	102330039	90	16	30	1,88	103330039	90	16	40	2,63
40	125,1	121,40	101330040	70	16	30	1,14	102330040	90	16	30	1,95	103330040	90	16	40	2,74
42	132,1	127,46	101330042	*78	16	35	1,56	102330042	*88	20	50	2,44					
45	141,1	136,54	101330045	*78	16	35	1,66	102330045	*88	20	50	3,15	103330045	*88	20	60	4,15
46	144,2	139,58	101330046	*78	16	35	1,67										
48	150,2	145,64	101330048	*78	16	35	1,75	102330048	*88	20	50	3,43					
50	156,3	151,69	101330050	*78	20	35	1,80	102330050	*88	20	50	3,53	103330050	*88	20	60	4,80
55	171,4	166,85	101330055	*78	20	35	1,89										
57	177,5	172,91	101330057	*78	20	35	1,96	102330057	*88	20	50	4,16	103330057	*88	25	60	5,80
60	186,6	181,99	101330060	*78	20	35	2,03	102330060	*88	20	50	4,45	103330060	*88	25	60	6,21
76	235,1	230,49	101330076	*78	20	35	2,67	102330076	*88	25	50	6,23	103330076	*88	25	60	9,26
95	292,7	288,08	101330095	*88	25	40	4,06	102330095	*108	25	50	9,76	103330095	*120	25	60	15,18



PIGNONI PER CATENE A RULLI - DIN 8187 - ISO 606

SPROCKETS FOR ROLLER CHAINS - DIN 8187 - ISO 606

1/2" x 1/8"
12,7 x 3,3 mm
Rullo 7,75 mm
081 - 1

B1	B2	B3	b1	C	r3
3				0,8	13

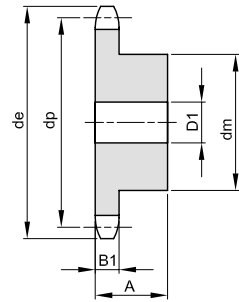
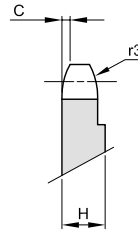
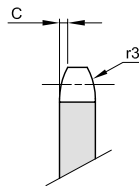

Da Z 31 H=4 mm

Materiale: Acciaio C45

Z	de	dp	semplici					doppi				tripli						
			codice	dm	D1	A	Kg.	codice	dm	D2	A	Kg.	codice	dm	D3	A	Kg.	
8	39,5	33,18	101341008	21	8	14	0,04											
9	43,4	37,13	101341009	25	8	14	0,06											
10	47,4	41,10	101341010	28	8	14	0,07											
11	51,4	45,07	101341011	31	8	16	0,10											
12	55,4	49,07	101341012	35	8	16	0,13											
13	59,4	53,06	101341013	39	8	16	0,16											
14	63,4	57,07	101341014	43	8	16	0,19											
15	67,4	61,09	101341015	47	8	16	0,23											
16	71,4	65,10	101341016	50	10	18	0,29											
17	75,4	69,11	101341017	50	10	18	0,30											
18	79,4	73,14	101341018	50	10	18	0,31											
19	83,5	77,16	101341019	50	10	18	0,32											
20	87,5	81,19	101341020	50	10	18	0,33											
21	91,5	85,22	101341021	60	12	20	0,48											
22	95,5	89,24	101341022	60	12	20	0,49											
23	99,6	93,27	101341023	60	12	20	0,51											
24	103,6	97,29	101341024	60	12	20	0,52											
25	107,6	101,33	101341025	60	12	20	0,53											
26	111,7	105,36	101341026	70	16	20	0,67											
27	115,7	109,40	101341027	70	16	20	0,69											
28	119,7	113,42	101341028	70	16	20	0,70											
29	123,8	117,46	101341029	70	16	20	0,72											
30	127,8	121,50	101341030	70	16	20	0,74											
31	131,8	125,54																
32	135,9	129,56	101341032	70	16	20	0,77											
33	139,9	133,60																
34	143,9	137,64	101341034	70	16	20	0,81											
35	148,0	141,68	101341035	70	16	20	0,83											
36	152,0	145,72	101341036	70	16	25	1,00											
37	156,1	149,76	101341037	70	16	25	1,02											
38	160,1	153,80	101341038	70	16	25	1,04											
39	164,1	157,83	101341039	70	16	25	1,06											
40	168,2	161,87	101341040	70	16	25	1,09											



PIGNONI PER CATENE A RULLI - DIN 8187 - ISO 606

SPROCKETS FOR ROLLER CHAINS - DIN 8187 - ISO 606

1/2" x 3/16"
12,7 x 4,88 mm
 Rullo 7,75 mm
083 - 1 / 084 - 1

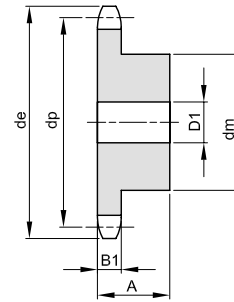
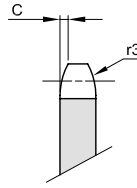

B1	B2	B3	b1	C	r3
4,5				1,3	13

Materiale: Acciaio C45

Z	de	dp	semplici					doppi				tripli					
			codice	dm	D1	A	Kg.	codice	dm	D2	A	Kg.	codice	dm	D3	A	Kg.
8	39,5	33,18	101342008	21	8	14	0,04										
9	43,4	37,13	101342009	25	8	14	0,06										
10	47,4	41,10	101342010	28	8	14	0,08										
11	51,4	45,07	101342011	31	8	16	0,11										
12	55,4	49,07	101342012	35	8	16	0,14										
13	59,4	53,06	101342013	39	8	16	0,17										
14	63,4	57,07	101342014	43	8	16	0,20										
15	67,4	61,09	101342015	47	8	16	0,24										
16	71,4	65,10	101342016	50	10	18	0,30										
17	75,4	69,11	101342017	50	10	18	0,31										
18	79,4	73,14	101342018	50	10	18	0,33										
19	83,5	77,16	101342019	50	10	18	0,34										
20	87,5	81,19	101342020	50	10	18	0,36										
21	91,5	85,22	101342021	60	12	20	0,51										
22	95,5	89,24	101342022	60	12	20	0,53										
23	99,6	93,27	101342023	60	12	20	0,55										
24	103,6	97,29	101342024	60	12	20	0,57										
25	107,6	101,33	101342025	60	12	20	0,59										
26	111,7	105,36	101342026	70	16	20	0,72										
27	115,7	109,40	101342027	70	16	20	0,74										
28	119,7	113,42	101342028	70	16	20	0,77										
29	123,8	117,46	101342029	70	16	20	0,79										
30	127,8	121,50	101342030	70	16	20	0,82										
31	131,8	125,54	101342031	70	16	20	0,85										
32	135,9	129,56	101342032	70	16	20	0,87										
33	139,9	133,60	101342033	70	16	20	0,90										
34	143,9	137,64	101342034	70	16	20	0,93										
35	148,0	141,68	101342035	70	16	20	0,96										
36	152,0	145,72	101342036	70	16	25	1,14										
37	156,1	149,76	101342037	70	16	25	1,17										
38	160,1	153,80	101342038	70	16	25	1,20										
39	164,1	157,83	101342039	70	16	25	1,24										
40	168,2	161,87	101342040	70	16	25	1,27										



PIGNONI PER CATENE A RULLI - DIN 8187 - ISO 606

SPROCKETS FOR ROLLER CHAINS - DIN 8187 - ISO 606

1/2" x 5/16"
12,7 x 7,75 mm
Rullo 8,51 mm
08B - 1 - 2 - 3

B1	B2	B3	b1	C	r3
7,2	21	34,9	7	1,3	13

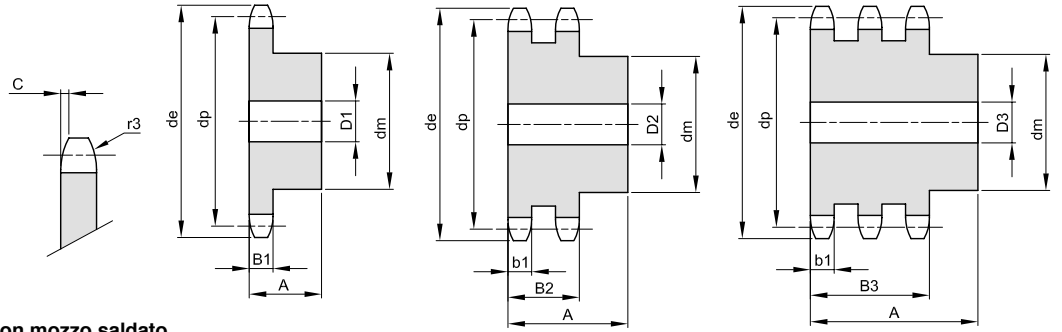

Materiale: Acciaio C45 / *Materiale: Fe - con mozzo saldato

Z	de	dp	semplici					doppi				tripli					
			codice	dm	D1	A	Kg.	codice	dm	D2	A	Kg.	codice	dm	D3	A	Kg.
8	38,0	33,18	101340008	20	10	25	0,06	102340008	20	10	32	0,09	103340008	20	10	46	0,13
9	42,0	37,13	101340009	24	10	25	0,09	102340009	24	10	32	0,13	103340009	24	12	46	0,18
10	45,9	41,10	101340010	26	10	25	0,12	102340010	28	10	32	0,18	103340010	28	12	46	0,24
11	49,9	45,07	101340011	29	10	25	0,15	102340011	32	12	35	0,24	103340011	32	16	50	0,31
12	53,9	49,07	101340012	33	10	28	0,21	102340012	35	12	35	0,30	103340012	35	16	50	0,39
13	57,9	53,06	101340013	37	10	28	0,26	102340013	38	12	35	0,36	103340013	38	16	50	0,49
14	61,9	57,07	101340014	41	10	28	0,32	102340014	42	12	35	0,44	103340014	42	16	50	0,60
15	65,9	61,09	101340015	45	10	28	0,38	102340015	46	12	35	0,52	103340015	46	16	50	0,72
16	69,9	65,10	101340016	50	12	28	0,46	102340016	50	16	38	0,63	103340016	50	16	50	0,85
17	74,0	69,11	101340017	52	12	28	0,51	102340017	54	16	38	0,73	103340017	54	16	50	0,99
18	78,0	73,14	101340018	56	12	28	0,59	102340018	58	16	38	0,85	103340018	58	16	50	1,14
19	82,0	77,16	101340019	60	12	28	0,67	102340019	62	16	38	0,97	103340019	62	16	50	1,30
20	86,0	81,19	101340020	64	12	28	0,76	102340020	66	16	38	1,10	103340020	66	16	50	1,47
21	90,1	85,22	101340021	68	14	28	0,85	102340021	70	16	40	1,29	103340021	70	16	55	1,79
22	94,1	89,24	101340022	70	14	28	0,91	102340022	70	16	40	1,37	103340022	70	16	55	1,93
23	98,1	93,27	101340023	70	14	28	0,95	102340023	70	16	40	1,46	103340023	70	16	55	2,08
24	102,1	97,29	101340024	70	14	28	0,98	102340024	75	16	40	1,64	103340024	75	16	55	2,32
25	106,2	101,33	101340025	70	14	28	1,01	102340025	80	16	40	1,82	103340025	80	16	55	2,57
26	110,2	105,36	101340026	70	16	30	1,09	102340026	85	16	40	2,02	103340026	85	20	55	2,79
27	114,2	109,40	101340027	70	16	30	1,13	102340027	85	16	40	2,12	103340027	85	20	55	2,96
28	118,3	113,42	101340028	70	16	30	1,17	102340028	90	16	40	2,34	103340028	90	20	55	3,25
29	122,3	117,46	101340029	80	16	30	1,42	102340029	95	16	40	2,56	103340029	95	20	55	3,55
30	126,3	121,50	101340030	80	16	30	1,46	102340030	100	16	40	2,79	103340030	100	20	55	3,86
31	130,4	125,54	101340031	90	16	30	1,74	102340031	100	20	40	2,87	103340031	110	20	55	4,32
32	134,4	129,56	101340032	90	16	30	1,78	102340032	100	20	40	3,00	103340032	110	20	55	4,53
33	138,4	133,60	101340033	90	16	30	1,83	102340033	100	20	40	3,13	103340033	110	20	55	4,74
34	142,5	137,64	101340034	90	16	30	1,88	102340034	100	20	40	3,26	103340034	110	20	55	4,97
35	146,5	141,68	101340035	90	16	30	1,93	102340035	100	20	40	3,40	103340035	110	20	55	5,20
36	150,6	145,72	101340036	90	16	35	2,22	102340036	100	20	40	3,54	103340036	120	25	55	5,64
37	154,6	149,76	101340037	90	16	35	2,27	102340037	100	20	40	3,69	103340037	120	25	55	5,88
38	158,6	153,80	101340038	90	16	35	2,32	102340038	100	20	40	3,84	103340038	120	25	55	6,14
39	162,7	157,83	101340039	90	16	35	2,38	102340039	100	20	40	4,00	103340039	120	25	55	6,40
40	166,7	161,87	101340040	90	16	35	2,43	102340040	100	20	40	4,15	103340040	120	25	55	6,66
42	176,5	169,95	101340042	*88	20	42	2,77	102340042	*108	20	55	5,67					
45	188,6	182,07	101340045	*88	20	42	3,00	102340045	*108	20	55	6,26	103340045	*120	25	68	9,12
46	192,6	186,10	101340046	*88	20	42	3,06	102340046	*108	20	55	6,39					
48	200,7	194,18	101340048	*88	20	42	3,16	102340048	*108	20	55	6,75					
50	208,8	202,26	101340050	*88	20	42	3,30	102340050	*108	20	55	7,17	103340050	*120	25	68	10,74
55	229,0	222,46	101340055	*88	20	42	3,62										
57	237,1	230,54	101340057	*88	20	42	3,85	102340057	*108	25	55	8,65	103340057	*120	25	68	13,26
60	249,2	242,66	101340060	*88	20	42	4,08	102340060	*108	25	55	9,35	103340060	*120	25	68	14,47
76	313,9	307,33	101340076	*88	25	42	5,56	102340076	*108	25	55	13,30	103340076	*120	25	68	21,78
95	390,7	384,11	101340095	*108	25	42	8,56	102340095	*120	25	55	21,13	103340095	*136	25	68	34,00



PIGNONI PER CATENE A RULLI - DIN 8187 - ISO 606

SPROCKETS FOR ROLLER CHAINS - DIN 8187 - ISO 606

5/8" x 3/8"
15,875 x 9,65 mm
 Rullo 10,16 mm
10B - 1 - 2 - 3

B1	B2	B3	b1	C	r3
9,1	25,5	42,1	9	1,6	16

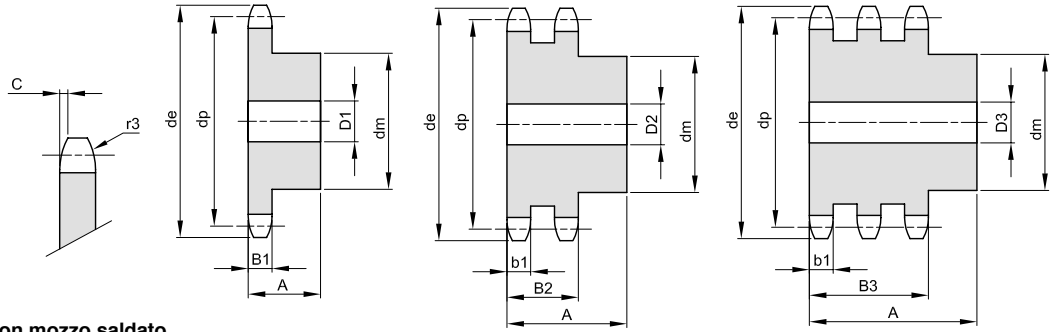

Materiale: Acciaio C45 / *Materiale: Fe - con mozzo saldato

Z	de	dp	semplici					doppi					tripli				
			codice	dm	D1	A	Kg.	codice	dm	D2	A	Kg.	codice	dm	D3	A	Kg.
8	48,4	41,48	101350008	25	10	25	0,12	102350008	25	12	40	0,19	103350008	25	12	55	0,27
9	53,3	46,42	101350009	30	10	25	0,16	102350009	30	12	40	0,27	103350009	30	12	55	0,38
10	58,3	51,37	101350010	35	10	25	0,22	102350010	35	12	40	0,36	103350010	35	16	55	0,47
11	63,2	56,34	101350011	37	12	30	0,29	102350011	39	16	40	0,43	103350011	39	16	55	0,61
12	68,2	61,34	101350012	42	12	30	0,37	102350012	44	16	40	0,55	103350012	44	16	55	0,78
13	73,2	66,32	101350013	47	12	30	0,46	102350013	49	16	40	0,68	103350013	49	16	55	0,96
14	78,2	71,34	101350014	52	12	30	0,56	102350014	54	16	40	0,82	103350014	54	16	55	1,15
15	83,2	76,36	101350015	57	12	30	0,67	102350015	59	16	40	0,97	103350015	59	16	55	1,37
16	88,3	81,37	101350016	60	12	30	0,76	102350016	64	16	45	1,26	103350016	64	16	60	1,72
17	93,3	86,39	101350017	60	12	30	0,88	102350017	69	16	45	1,46	103350017	69	16	60	1,99
18	98,3	91,42	101350018	70	14	30	1,01	102350018	74	16	45	1,67	103350018	74	16	60	2,27
19	103,3	96,45	101350019	70	14	30	1,15	102350019	79	16	45	1,90	103350019	79	16	60	2,58
20	108,4	101,49	101350020	75	14	30	1,21	102350020	84	16	45	2,14	103350020	84	16	60	2,91
21	113,4	106,52	101350021	75	16	30	1,35	102350021	85	16	45	2,27	103350021	85	20	60	3,12
22	118,4	111,55	101350022	80	16	30	1,41	102350022	90	16	45	2,54	103350022	90	20	60	3,48
23	123,5	116,58	101350023	80	16	30	1,47	102350023	95	16	45	2,82	103350023	95	20	60	3,86
24	128,5	121,62	101350024	80	16	30	1,54	102350024	100	16	45	3,11	103350024	100	20	60	4,25
25	133,6	126,66	101350025	80	16	30	1,60	102350025	105	16	45	3,15	103350025	105	20	60	4,67
26	138,6	131,70	101350026	85	20	35	1,96	102350026	110	20	45	3,74	103350026	110	20	60	5,10
27	143,6	136,75	101350027	85	20	35	2,04	102350027	110	20	45	3,94	103350027	110	20	60	5,43
28	148,7	141,78	101350028	90	20	35	2,25	102350028	115	20	45	4,28	103350028	115	20	60	5,90
29	153,7	146,83	101350029	90	20	35	2,33	102350029	115	20	45	4,50	103350029	115	20	60	6,25
30	158,8	151,87	101350030	90	20	35	2,41	102350030	120	20	45	4,87	103350030	120	20	60	6,65
31	163,8	156,92	101350031	95	20	35	2,64	102350031	120	20	45	5,10	103350031	120	20	60	7,18
32	168,9	161,95	101350032	95	20	35	2,73	102350032	120	20	45	5,34	103350032	120	20	60	7,56
33	173,9	167,00	101350033	95	20	35	2,82	102350033	120	20	45	5,59	103350033	120	20	60	7,97
34	178,9	172,05	101350034	95	20	35	2,92	102350034	120	20	45	5,84	103350034	120	20	60	8,36
35	184,0	177,10	101350035	95	20	35	3,01	102350035	120	20	45	6,11	103350035	120	20	60	8,74
36	189,0	182,15	101350036	100	20	35	3,27	102350036	120	20	45	6,38	103350036	120	25	60	9,15
37	194,1	187,20	101350037	100	20	35	3,37	102350037	120	20	45	6,66	103350037	120	25	60	9,61
38	199,1	192,24	101350038	100	20	35	3,47	102350038	120	20	45	6,95	103350038	120	25	60	10,08
39	204,2	197,29	101350039	100	20	35	3,58	102350039	120	20	45	7,25	103350039	120	25	60	10,57
40	209,2	202,34	101350040	100	20	35	3,69	102350040	120	20	45	7,55	103350040	120	25	60	11,07
42	220,8	212,44	101350042	*108	20	43	4,73	102350042	*120	25	59	9,35					
45	236,0	227,58	101350045	*108	20	43	5,09	102350045	*120	25	59	10,32	103350045	*136	25	74	15,70
46	241,0	236,63	101350046	*108	20	43	5,19	102350046	*120	25	59	10,67					
48	251,1	242,73	101350048	*108	20	43	5,43	102350048	*120	25	59	11,40					
50	261,2	252,82	101350050	*108	20	43	5,70	102350050	*120	25	59	12,11	103350050	*136	25	74	18,83
55	286,5	278,08	101350055	*108	20	43	6,40										
57	296,6	288,18	101350057	*108	25	43	6,66	102350057	*120	25	59	15,74	103350057	*136	25	74	23,40
60	311,7	303,32	101350060	*108	25	43	7,15	102350060	*120	25	59	16,40	103350060	*136	25	74	25,80
76	392,5	384,16	101350076	*108	25	43	10,28	102350076	*120	25	59	24,93	103350076	*145	30	75	40,25
95	488,5	480,14	101350095	*118	30	59	16,36	102350095	*145	30	58	38,90	103350095	*145	30	75	55,35



PIGNONI PER CATENE A RULLI - DIN 8187 - ISO 606

SPROCKETS FOR ROLLER CHAINS - DIN 8187 - ISO 606

3/4" x 7/16"
19,05 x 11,68 mm
 Rullo 12,07 mm
12B - 1 - 2 - 3

B1	B2	B3	b1	C	r3
11,1	30,3	49,8	10,8	2	19

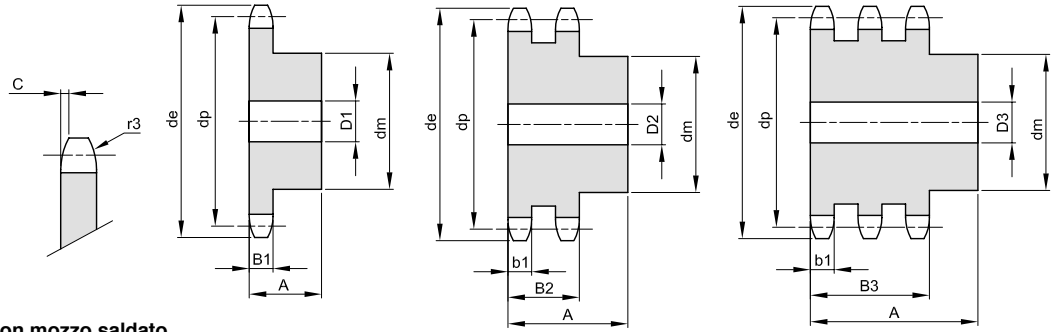

Materiale: Acciaio C45 / *Materiale: Fe - con mozzo saldato

Z	de	dp	semplici					doppi					tripli				
			codice	dm	D1	A	Kg.	codice	dm	D2	A	Kg.	codice	dm	D3	A	Kg.
8	58,0	49,78	101360008	31	12	30	0,21	102360008	31	12	45	0,31	103360008	31	16	65	0,45
9	63,9	55,70	101360009	37	12	30	0,29	102360009	37	12	45	0,44	103360009	37	16	65	0,64
10	69,8	61,64	101360010	42	12	30	0,38	102360010	42	12	45	0,59	103360010	42	16	65	0,86
11	75,8	67,61	101360011	46	16	35	0,51	102360011	47	16	50	0,81	103360011	47	20	70	1,09
12	81,8	73,60	101360012	52	16	35	0,65	102360012	53	16	50	1,02	103360012	53	20	70	1,39
13	87,8	79,59	101360013	58	16	35	0,80	102360013	59	16	50	1,25	103360013	59	20	70	1,72
14	93,8	85,61	101360014	64	16	35	0,97	102360014	65	16	50	1,46	103360014	65	20	70	2,08
15	99,8	91,63	101360015	70	16	35	1,16	102360015	71	16	50	1,74	103360015	71	20	70	2,47
16	105,8	97,65	101360016	75	16	35	1,34	102360016	77	20	50	2,03	103360016	77	20	70	2,89
17	111,9	103,67	101360017	80	16	35	1,53	102360017	83	20	50	2,36	103360017	83	20	70	3,34
18	117,9	109,71	101360018	80	16	35	1,62	102360018	89	20	50	2,70	103360018	89	20	70	3,83
19	123,9	115,75	101360019	80	16	35	1,70	102360019	95	20	50	3,07	103360019	95	20	70	4,35
20	130,0	121,78	101360020	80	16	35	1,80	102360020	100	20	50	3,43	103360020	100	20	70	4,87
21	136,0	127,82	101360021	90	20	40	2,35	102360021	100	20	50	3,69	103360021	100	20	70	5,20
22	142,0	133,86	101360022	90	20	40	2,46	102360022	100	20	50	3,97	103360022	100	20	70	5,65
23	148,1	139,90	101360023	90	20	40	2,56	102360023	110	20	50	4,51	103360023	110	20	70	6,38
24	154,1	145,94	101360024	90	20	40	2,68	102360024	110	20	50	4,81	103360024	110	20	70	6,87
25	160,2	152,00	101360025	90	20	40	2,80	102360025	120	20	50	5,41	103360025	120	20	70	7,77
26	166,2	158,04	101360026	95	20	40	3,08	102360026	120	20	50	5,73	103360026	120	20	70	8,21
27	172,3	164,09	101360027	95	20	40	3,21	102360027	120	20	50	6,08	103360027	120	20	70	8,77
28	178,3	170,13	101360028	95	20	40	3,34	102360028	120	20	50	6,43	103360028	120	20	70	9,35
29	184,4	176,19	101360029	95	20	40	3,48	102360029	120	20	50	6,80	103360029	120	20	70	9,96
30	190,4	182,25	101360030	95	20	40	3,63	102360030	120	20	50	7,19	103360030	120	20	70	10,59
31	196,5	188,31	101360031	95	20	40	3,78	102360031	120	20	50	7,59	103360031	130	25	70	11,55
32	202,5	194,35	101360032	95	20	40	3,93	102360032	120	20	50	8,00	103360032	130	25	70	12,22
33	208,6	200,40	101360033	95	20	40	4,09	102360033	120	20	50	8,42	103360033	130	25	70	12,92
34	214,6	206,46	101360034	95	20	40	4,25	102360034	120	20	50	8,86	103360034	130	25	70	13,64
35	220,7	212,52	101360035	95	20	40	4,42	102360035	120	20	50	9,31	103360035	130	25	70	14,38
36	226,8	218,58	101360036	100	20	40	4,71	102360036	120	25	50	9,71	103360036	130	25	70	15,14
37	232,8	224,64	101360037	100	20	40	4,89	102360037	120	25	50	10,19	103360037	130	25	70	15,93
38	238,9	230,69	101360038	100	20	40	5,07	102360038	120	25	50	10,78	103360038	130	25	70	16,73
39	244,9	236,75	101360039	100	20	40	5,26	102360039	120	25	50	11,19	103360039	130	25	70	17,57
40	251,0	242,81	101360040	100	20	40	5,46	102360040	120	25	50	11,71	103360040	130	25	70	18,42
42	265,0	254,93	101360042	*118	25	61	8,14	102360042	*136	25	62	14,51					
45	283,2	273,10	101360045	*118	25	61	8,85	102360045	*136	25	62	16,35	103360045	*140	25	72	23,55
46	289,2	279,16	101360046	*118	25	61	9,22	102360046	*136	25	62	16,80					
48	301,4	291,27	101360048	*118	25	61	9,67	102360048	*136	25	62	18,18					
50	313,5	303,39	101360050	*118	25	61	10,15	102360050	*136	25	62	19,44	103360050	*140	25	72	28,73
55	343,8	333,70	101360055	*118	25	61	11,29										
57	355,9	345,81	101360057	*118	25	61	11,85	102360057	*136	25	62	24,43	103360057	*140	30	75	37,16
60	374,1	363,99	101360060	*118	25	61	12,71	102360060	*136	25	62	26,77	103360060	*140	30	75	41,01
76	471,1	460,99	101360076	*118	30	61	18,02	102360076	*145	30	63	41,88	103360076	*150	30	75	65,41
95	586,2	576,17	101360095	*133	30	62	27,45	102360095	*145	30	63	63,79	103360095	*150	30	75	101,37



PIGNONI PER CATENE A RULLI - DIN 8187 - ISO 606

SPROCKETS FOR ROLLER CHAINS - DIN 8187 - ISO 606

1" x 17,02 mm
25,4 x 17,02 mm
Rullo 15,88 mm
16B - 1 - 2 - 3

B1	B2	B3	b1	C	r3
16,2	47,7	79,6	15,8	2,5	26

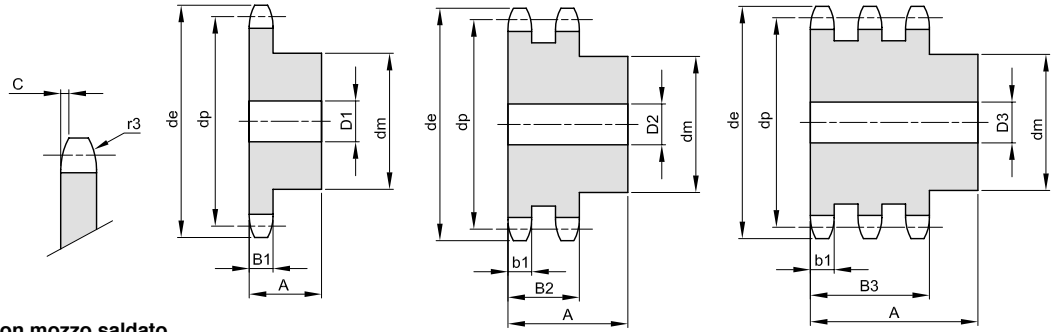

Materiale: Acciaio C45 / *Materiale: Fe - con mozzo saldato

Z	de	dp	semplici					doppi					tripli				
			codice	dm	D1	A	Kg.	codice	dm	D2	A	Kg.	codice	dm	D3	A	Kg.
8	77,9	66,37	101380008	42	16	35	0,47	102380008	42	20	65	0,81	103380008	42	20	95	1,19
9	85,8	74,27	101380009	50	16	35	0,66	102380009	50	20	65	1,15	103380009	50	20	95	1,68
10	93,8	82,19	101380010	55	16	35	0,83	102380010	56	20	65	1,52	103380010	56	20	95	2,24
11	101,7	90,14	101380011	61	16	40	1,14	102380011	64	20	70	2,08	103380011	64	25	100	2,86
12	109,7	98,14	101380012	69	16	40	1,43	102380012	72	20	70	2,60	103380012	72	25	100	3,62
13	117,7	106,12	101380013	78	16	40	1,77	102380013	80	20	70	3,18	103380013	80	25	100	4,45
14	125,7	114,15	101380014	84	16	40	2,08	102380014	88	20	70	3,82	103380014	88	25	100	5,37
15	133,7	122,17	101380015	92	16	40	2,46	102380015	96	20	70	4,51	103380015	96	25	100	6,37
16	141,8	130,20	101380016	100	20	45	3,14	102380016	104	20	70	5,17	103380016	104	25	100	7,45
17	149,8	138,22	101380017	100	20	45	3,33	102380017	112	20	70	5,98	103380017	112	25	100	8,60
18	157,8	146,28	101380018	100	20	45	3,56	102380018	120	20	70	6,84	103380018	120	25	100	9,84
19	165,9	154,33	101380019	100	20	45	3,78	102380019	128	20	70	7,76	103380019	128	25	100	11,16
20	173,9	162,38	101380020	100	20	45	4,03	102380020	130	20	70	8,52	103380020	130	25	100	12,36
21	182,0	170,43	101380021	110	20	50	5,01	102380021	130	25	70	9,24	103380021	130	25	100	13,56
22	190,1	178,48	101380022	110	20	50	5,28	102380022	130	25	70	10,00	103380022	130	25	100	14,82
23	198,1	186,53	101380023	110	20	50	5,56	102380023	130	25	70	10,80	103380023	130	25	100	16,15
24	206,2	194,59	101380024	110	20	50	5,86	102380024	130	25	70	11,64	103380024	130	25	100	17,53
25	214,2	202,66	101380025	110	20	50	6,16	102380025	130	25	70	12,52	103380025	130	25	100	18,99
26	222,3	210,72	101380026	120	20	50	6,96	102380026	130	25	70	13,43	103380026	130	30	100	20,34
27	230,4	218,79	101380027	120	20	50	7,30	102380027	130	25	70	14,38	103380027	130	30	100	21,92
28	238,4	226,85	101380028	120	20	50	7,64	102380028	130	25	70	15,38	103380028	130	30	100	23,57
29	246,5	234,92	101380029	120	20	50	8,00	102380029	130	25	70	16,41	103380029	130	30	100	25,27
30	254,6	243,00	101380030	120	20	50	8,38	102380030	130	25	70	17,48	103380030	130	30	100	27,05
31	262,6	251,08	101380031	120	25	50	8,69	102380031	140	25	70	18,96	103380031	140	30	100	29,23
32	270,7	259,13	101380032	120	25	50	9,09	102380032	140	25	70	20,10	103380032	140	30	100	31,13
33	278,8	267,21	101380033	120	25	50	9,50	102380033	140	25	70	21,29	103380033	140	30	100	33,10
34	286,9	275,28	101380034	120	25	50	9,93	102380034	140	25	70	22,21	103380034	140	30	100	35,13
35	294,9	283,36	101380035	120	25	50	10,36	102380035	140	25	70	23,77	103380035	140	30	100	37,23
36	303,0	291,44	101380036	120	25	50	10,81	102380036	140	25	70	25,07	103380036	140	30	100	39,39
37	311,1	299,51	101380037	120	25	50	11,28	102380037	140	25	70	26,41					
38	319,2	307,59	101380038	120	25	50	11,76	102380038	140	25	70	27,79	103380038	140	30	100	43,90
39	327,2	315,67	101380039	120	25	50	12,25	102380039	140	25	70	29,20					
40	335,3	323,73	101380040	120	25	50	12,75	102380040	140	25	70	30,65	103380040	140	30	100	48,67
42	353,7	339,90	101380042	*133	25	68	16,54	102380042	*140	25	70	33,63					
45	377,9	364,12	101380045	*133	25	68	18,15	102380045	*140	25	70	38,44	103380045	*160	30	110	63,94
46	386,0	372,21	101380046	*133	25	68	18,69	102380046	*140	25	70	40,13					
48	402,1	388,36	101380048	*133	25	68	19,86	102380048	*140	25	70	43,61					
50	418,3	404,52	101380050	*133	25	68	20,89	102380050	*140	25	70	47,25	103380050	*160	30	110	78,58
57	474,9	461,07	101380057	*133	30	68	25,52	102380057	*160	40	82	63,45	103380057	*180	40	112	103,03
60	499,1	485,32	101380060	*133	30	68	27,76	102380060	*160	40	82	70,00					
76	628,4	614,65	101380076	*145	30	68	42,97	102380076	*180	40	109	110,79	103380076	*180	40	112	181,86
95	782,0	768,22	101380095	*160	30	78	63,92	102380095	*180	40	109	178,48	103380095	*180	40	112	283,85



PIGNONI PER CATENE A RULLI - DIN 8187 - ISO 606

SPROCKETS FOR ROLLER CHAINS - DIN 8187 - ISO 606

1"1/4 x 3/4"
31,75 x 19,56 mm
 Rullo 19,05 mm
20B - 1 - 2 - 3

B1	B2	B3	b1	C	r3
18,5	54,6	91	18,2	3,5	32

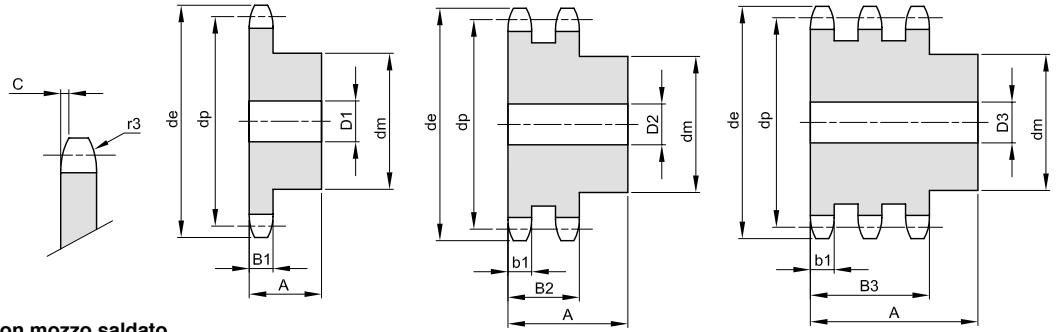

Materiale: Acciaio C45 / *Materiale: Fe - con mozzo saldato

Z	de	dp	semplici					doppi				tripli					
			codice	dm	D1	A	Kg.	codice	dm	D2	A	Kg.	codice	dm	D3	A	Kg.
8	96,0	82,96	101400008	53	20	40	0,85	102400008	53	20	75	1,58	103400008	53	25	110	2,15
9	106,5	92,84	101400009	63	20	40	1,19	102400009	63	20	75	2,19	103400009	63	25	110	3,05
10	117,0	102,74	101400010	70	20	40	1,51	102400010	70	20	75	2,85	103400010	70	25	110	4,04
11	127,0	112,68	101400011	77	20	45	2,04	102400011	80	25	80	3,72	103400011	80	30	115	5,19
12	137,0	122,68	101400012	88	20	45	2,58	102400012	90	25	80	4,66	103400012	90	30	115	6,55
13	147,5	132,65	101400013	98	20	45	3,15	102400013	100	25	80	5,70	103400013	100	30	115	8,06
14	157,6	142,68	101400014	108	20	45	3,78	102400014	110	25	80	6,84	103400014	110	30	115	9,71
15	167,7	152,72	101400015	118	20	45	4,47	102400015	120	25	80	8,08	103400015	120	30	115	11,50
16	177,7	162,75	101400016	120	25	50	5,25	102400016	120	30	80	8,90	103400016	120	30	115	13,06
17	187,7	172,78	101400017	120	25	50	5,61	102400017	120	30	80	9,92	103400017	120	30	115	14,65
18	197,8	182,85	101400018	120	25	50	6,00	102400018	120	30	80	11,00	103400018	120	30	115	17,07
19	207,9	192,91	101400019	120	25	50	6,40	102400019	120	30	80	12,16	103400019	120	30	115	18,45
20	217,9	202,98	101400020	120	25	50	6,84	102400020	120	30	80	13,38	103400020	120	30	115	20,48
21	228,0	213,04	101400021	140	25	55	8,79	102400021	140	30	80	15,49	103400021	140	30	115	23,38
22	238,1	223,11	101400022	140	25	55	9,27	102400022	140	30	80	16,86	103400022	140	30	115	25,64
23	248,2	233,17	101400023	140	25	55	9,77	102400023	140	30	80	18,29	103400023	140	30	115	28,00
24	258,3	243,23	101400024	140	25	55	10,30	102400024	140	30	80	19,79	103400024	140	30	115	30,49
25	268,4	253,33	101400025	140	25	55	10,85	102400025	140	30	80	21,36	103400025	140	30	115	33,09
26	278,4	263,40	101400026	150	30	55	12,07	102400026	150	30	80	23,45	103400026	150	30	115	36,23
27	288,5	273,48	101400027	150	30	55	12,67	102400027	150	30	80	25,15	103400027	150	30	115	39,06
28	298,5	283,56	101400028	150	30	55	13,29	102400028	150	30	80	26,93	103400028	150	30	115	42,00
29	308,6	293,65	101400029	150	30	55	13,93	102400029	150	30	80	28,77					
30	318,7	303,75	101400030	150	30	55	14,60	102400030	150	30	80	30,69	103400030	150	30	115	48,23
31	328,8	313,85	101400031	*150	30	55	15,28	102400031	*150	30	80	32,67					
32	338,9	323,91	101400032	*150	30	55	16,00	102400032	*150	30	80	34,72	103400032	*150	30	115	54,91
33	349,0	334,01	101400033	*150	30	55	16,73										
34	359,1	344,10	101400034	*150	30	55	17,49	102400034	*150	30	80	39,03	103400034	*150	30	115	62,35
35	369,2	354,20	101400035	*150	30	55	18,27	102400035	*150	30	80	41,28	103400035	*150	30	115	65,80
36	379,2	364,30	101400036	*150	30	55	19,08	102400036	*150	30	80	43,61	103400036	*150	30	115	69,66
37	389,3	374,39	101400037	*150	30	55	19,91										
38	399,4	384,49	101400038	*150	30	55	20,76	102400038	*150	30	80	48,46	103400038	*150	30	115	77,72
39	409,5	394,59	101400039	*150	30	55	21,73										
40	419,6	404,66	101400040	*150	30	55	22,53	102400040	*150	30	80	53,60	103400040	*150	30	115	86,24
42	440,8	424,88	101400042	*160	30	80	28,84										
45	471,1	455,17	101400045	*160	30	80	31,79	102400045	*160	30	101	71,32	103400045	*160	40	121	110,41
46	481,2	465,26	101400046	*160	30	80	32,83	102400046	*160	30	101	74,34					
48	501,4	485,46	101400048	*160	30	80	35,00										
50	521,6	505,65	101400050	*160	30	80	37,21	102400050	*160	30	101	87,08	103400050	*160	40	121	136,59
57	592,3	576,36	101400057	*160	30	80	45,79	102400057	*180	40	116	116,28	103400057	*200	40	123	181,21
60	622,6	606,65	101400060	*160	30	80	49,83										
76	784,3	768,32	101400076	*160	30	80	75,81	102400076	*180	40	116	200,96	103400076	*200	40	123	322,03
95	976,2	960,28	101400095	*168	30	93	114,96	102400095	*200	40	116	313,59					



PIGNONI PER CATENE A RULLI - DIN 8187 - ISO 606

SPROCKETS FOR ROLLER CHAINS - DIN 8187 - ISO 606

1"1/2 x 1"
38,1 x 25,4 mm
 Rullo 25,4 mm
24B - 1 - 2 - 3

B1	B2	B3	b1	C	r3
24,1	72	120,3	23,6	4	38

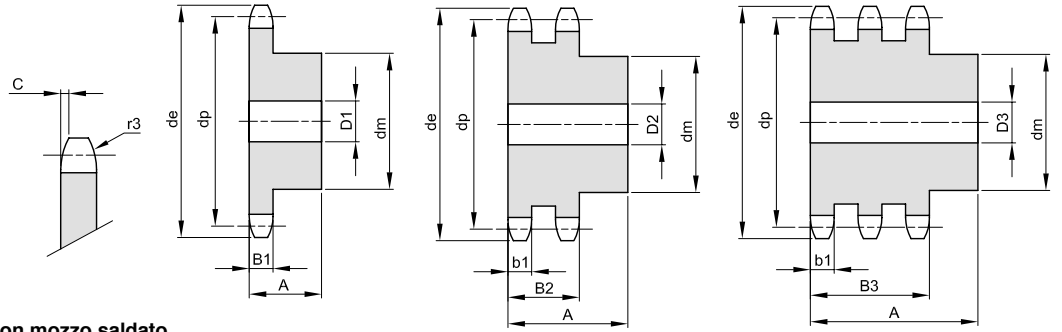

Materiale: Acciaio C45 / *Materiale: Fe - con mozzo saldato

Z	de	dp	semplici					doppi				tripli					
			codice	dm	D1	A	Kg.	codice	dm	D2	A	Kg.	codice	dm	D3	A	Kg.
8	113,0	99,55	101420008	58	20	45	1,38	102420008	58	25	95	2,70	103420008	58	25	140	4,00
9	125,0	111,40	101420009	70	20	45	1,90	102420009	70	25	95	3,79	103420009	70	25	140	5,62
10	137,0	123,29	101420010	80	20	45	2,47	102420010	80	25	95	5,01	103420010	80	25	140	7,45
11	149,0	135,21	101420011	90	25	50	3,27	102420011	90	25	100	6,62	103420011	90	30	150	9,73
12	161,0	147,22	101420012	102	25	50	4,09	102420012	102	25	100	8,28	103420012	102	30	150	12,24
13	173,0	159,18	101420013	114	25	50	5,00	102420013	114	25	100	10,13	103420013	114	30	150	15,02
14	185,0	171,22	101420014	128	25	50	6,09	102420014	128	25	100	12,24	103420014	128	30	150	18,16
15	197,0	183,26	101420015	132	25	50	6,84	102420015	132	25	100	14,08	103420015	132	30	150	21,09
16	209,0	195,30	101420016	136	25	55	8,20	102420016	136	30	100	15,88	103420016	136	30	150	24,25
17	221,0	207,34	101420017	136	25	55	8,87	102420017	136	30	100	17,80	103420017	136	30	150	27,42
18	233,0	219,42	101420018	136	25	55	9,59	102420018	160	30	100	21,08	103420018	160	30	150	32,12
19	245,5	231,49	101420019	136	25	55	10,36	102420019	160	30	100	23,26	103420019	160	30	150	35,74
20	257,5	243,57	101420020	136	25	55	11,16	102420020	160	30	100	25,57	103420020	160	30	150	39,57
21	270,5	255,65	101420021	150	30	60	13,35	102420021	160	30	100	28,01	103420021	160	40	150	42,98
22	282,5	267,73	101420022	150	30	60	14,24	102420022	160	30	100	30,59	103420022	160	40	150	47,25
23	294,5	279,80	101420023	150	30	60	15,18	102420023	160	30	100	33,29	103420023	160	40	150	51,74
24	307,0	291,88	101420024	150	30	60	16,16	102420024	160	30	100	36,13	103420024	160	40	150	56,44
25	319,0	304,00	101420025	150	30	60	17,19	102420025	160	30	100	39,09	103420025	160	40	150	61,37
26	331,0	316,08	101420026	*150	30	60	18,25	102420026	*160	30	100	42,19	103420026	*160	40	150	66,52
27	343,0	328,19	101420027	*150	30	60	19,37	102420027	*160	30	100	45,41	103420027	*160	40	150	71,88
28	355,0	340,27	101420028	*150	30	60	20,52	102420028	*160	30	100	48,77	103420028	*160	40	150	77,46
29	367,5	352,38	101420029	*150	30	60	21,72	102420029	*160	30	100	52,26					
30	379,5	364,50	101420030	*150	30	60	22,97	102420030	*160	30	100	55,88	103420030	*160	40	150	89,28
31	391,5	376,62	101420031	*150	30	60	24,25	102420031	*160	40	100	59,19					
32	403,5	388,69	101420032	*150	30	60	25,59	102420032	*160	40	100	63,07	103420032	*160	40	150	101,97
33	415,5	400,81	101420033	*150	30	60	26,96	102420033	*160	40	100	67,08					
34	428,0	412,83	101420034	*150	30	60	28,38	102420034	*160	40	100	71,21					
35	440,0	425,04	101420035	*150	30	60	29,84	102420035	*160	40	100	75,49	103420035	*160	40	150	122,64
36	452,0	437,16	101420036	*150	30	60	31,34	102420036	*160	40	100	79,89					
37	464,0	449,27	101420037	*150	30	60	32,90	102420037	*160	40	100	84,43					
38	476,5	461,39	101420038	*150	30	60	34,49	102420038	*160	40	100	89,09	103420038	*160	40	150	145,28
40	501,5	485,62	101420040	*150	30	60	37,81	102420040	*160	40	100	98,80	103420040	*160	40	150	161,46
42	525,5	509,85	101420042	*168	30	99	48,52										
45	562,0	546,20	101420045	*168	30	99	54,08	102420045	*180	40	133	132,81	103420045	*200	40	153	209,06
46	574,0	558,32	101420046	*168	30	99	56,03										
48	598,5	582,55	101420048	*168	30	99	60,04										
50	622,5	606,78	101420050	*168	30	99	64,24	102420050	*180	40	133	162,65	103420050	*200	40	153	258,81
57	707,5	691,63	101420057	*168	30	99	80,28	102420057	*180	40	133	209,91	103420057	*200	40	153	337,62
60	745,0	727,97	101420060	*168	30	99	87,82										
76	939,0	921,98	101420076	*178	40	118	140,54	102420076	*200	40	133	373,88	103420076	*220	40	155	607,76
95	1169,0	1152,33	101420095	*178	40	118	210,67										



PIGNONI PER CATENE A RULLI - DIN 8187 - ISO 606

SPROCKETS FOR ROLLER CHAINS - DIN 8187 - ISO 606

1"3/4 x 1"1/4
44,45 x 30,99 mm
 Rullo 27,94 mm
28B - 1 - 2 - 3

B1	B2	B3	b1	C	r3
29,4	88,4	148	28,8	5	44

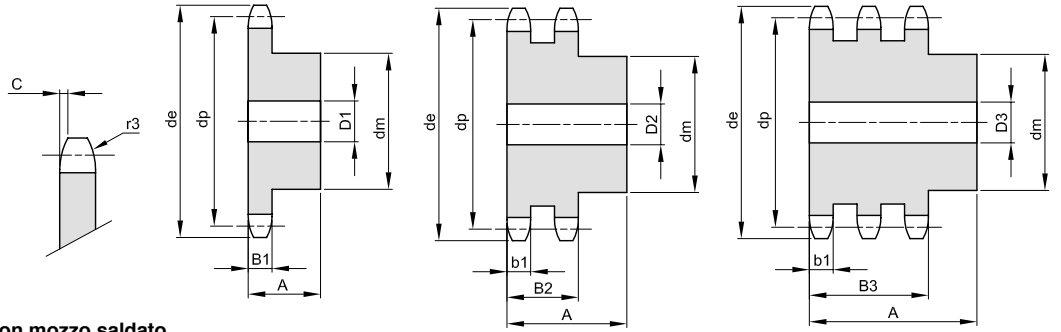

Materiale: Acciaio C45 / *Materiale: Fe - con mozzo saldato

Z	de	dp	semplici					doppi				tripli					
			codice	dm	D1	A	Kg.	codice	dm	D2	A	Kg.	codice	dm	D3	A	Kg.
8	132,0	116,15	101440008	74	25	70	2,86	102440008	74	30	120	4,75	103440008	74	30	180	7,04
9	146,0	129,96	101440009	88	25	70	4,00	102440009	88	30	120	6,66	103440009	88	30	180	9,89
10	160,0	143,85	101440010	100	25	70	5,18	102440010	100	30	120	8,79	103440010	100	30	180	13,10
11	174,0	157,77	101440011	112	25	70	6,51	102440011	112	30	120	11,19	103440011	112	30	180	16,73
12	188,0	171,74	101440012	125	25	70	8,04	102440012	125	30	120	13,91	103440012	125	30	180	20,84
13	204,0	185,75	101440013	125	25	70	8,88	102440013	125	30	120	16,25	103440013	125	30	180	24,70
14	218,0	199,76	101440014	125	25	70	9,79	102440014	125	30	120	18,81	103440014	125	30	180	28,93
15	232,0	213,79	101440015	125	25	70	10,77	102440015	145	30	120	22,64	103440015	145	30	180	34,58
16	246,0	227,84	101440016	160	30	75	14,96	102440016	160	30	120	26,52	103440016	160	30	180	40,44
17	260,0	241,90	101440017	160	30	75	16,09	102440017	160	30	120	29,74	103440017	160	30	180	45,77
18	274,0	255,98	101440018	160	30	75	17,28	102440018	160	30	120	33,17	103440018	160	30	180	51,76
19	289,0	270,06	101440019	160	30	75	18,56	102440019	180	30	120	38,14	103440019	180	30	180	58,07
20	303,0	284,15	101440020	160	30	75	19,90	102440020	180	30	120	42,02	103440020	180	30	180	64,49
21	317,0	298,24	101440021	160	30	75	21,31	102440021	180	30	120	49,10	103440021	180	40	180	71,28
22	331,0	312,34	101440022	*160	30	75	22,80	102440022	*180	30	120	50,40					
23	345,0	326,44	101440023	*160	30	75	24,36	102440023	*180	30	120	54,92	103440023	*180	40	180	85,94
24	359,0	340,55	101440024	*160	30	75	26,00										
25	373,0	354,66	101440025	*160	30	75	27,70	102440025	*180	30	120	64,62	103440025	*180	40	180	112,07
26	387,0	368,77	101440026	*160	30	75	29,48	102440026	*180	40	120	69,28					
27	401,0	382,88	101440027	*160	30	75	31,36										
28	416,0	397,00	101440028	*160	30	75	33,26	102440028	*180	40	120	80,28					
29	430,0	411,12	101440029														
30	444,0	425,24	101440030	*160	30	75	37,33	102440030	*180	40	120	92,17	103440030	*180	40	180	148,79
31	458,0	439,37	101440031														
32	472,0	453,49	101440032	*180	30	75	43,59										
33	486,0	467,62	101440033														
34	500,0	481,75	101440034	*180	30	75	48,24										
35	514,0	495,88	101440035	*180	30	75	50,57	102440035	*200	40	120	127,17					
36	529,0	510,01	101440036	*180	30	75	53,18										
37	543,0	524,13	101440037														
38	557,0	538,27	101440038	*180	30	75	58,00	102440038	*200	40	120	149,90	103440038	*200	40	180	244,01
40	585,0	566,54	101440040	*180	30	75	63,92	102440040	*200	40	120	167,15	103440040	*200	40	180	271,10
45	656,0	637,22	101440045	*180	30	75	79,12	102440045	*200	40	150	218,10	103440045	*200	40	209	352,63
50	726,0	707,91	101440050	*180	30	75	96,00	102440050	*200	40	150	267,99					
57	825,0	806,90	101440057	*180	40	123	129,33	102440057	*200	40	150	346,99	103440057	*200	40	209	567,76
60	869,0	849,32	101440060	*180	40	123	144,00										
76	1095,0	1075,62	101440076	*180	40	123	215,46	102440076	*200	40	150	615,35	103440076	*238	40	217	1024,97



PIGNONI PER CATENE A RULLI - DIN 8187 - ISO 606 SPROCKETS FOR ROLLER CHAINS - DIN 8187 - ISO 606

2" x 1"1/4
50,8 x 30,99 mm
Rullo 29,21 mm
32B - 1 - 2 - 3

B1	B2	B3	b1	C	r3
29,4	87,4	146	28,8	6	51

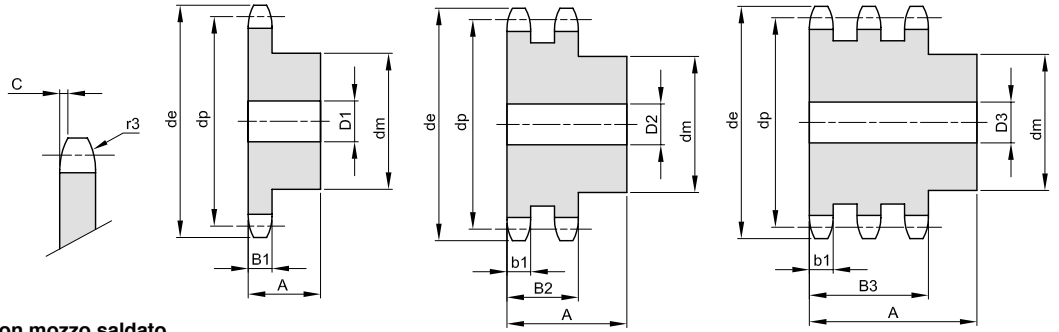

Materiale: Acciaio C45 / *Materiale: Fe - con mozzo saldato

Z	de	dp	semplici					doppi				tripli										
			codice	dm	D1	A	Kg.	codice	dm	D2	A	Kg.	codice	dm	D3	A	Kg.					
8	152,0	132,74	101460008	85	30	80	4,20										103460008	85	30	180	9,90	
9	168,0	148,54	101460009	100	30	80	5,78	102460009	100	30	120	9,14	103460009	100	30	180	13,65					
10	184,0	164,39	101460010	115	30	80	7,60	102460010	115	30	120	12,01	103460010	115	30	180	17,97					
11	200,0	181,31	101460011	125	30	80	9,26	102460011	125	35	120	14,75	103460011	125	35	180	22,22					
12	216,0	196,29	101460012	133	30	80	10,91	102460012	133	35	120	17,95	103460012	133	35	180	27,23					
13	235,0	212,29	101460013	145	30	80	13,05	102460013	145	35	120	21,68	103460013	145	35	180	32,98					
14	251,0	228,29	101460014	145	30	80	14,25	102460014	145	35	120	25,03	103460014	145	35	180	38,50					
15	267,0	244,30	101460015	145	30	80	15,53	102460015	160	35	120	29,30	103460015	160	35	180	45,04					
16	283,0	260,40	101460016	160	30	90	19,87	102460016	160	40	120	33,21	103460016	160	40	180	51,50					
17	299,0	276,46	101460017	160	30	90	21,35	102460017	180	40	120	38,76	103460017	200	40	180	61,45					
18	315,0	292,55	101460018	160	30	90	22,92	102460018	180	40	120	43,24	103460018	200	40	180	68,85					
19	331,0	308,66	101460019	160	30	90	24,53	102460019	200	40	120	49,52	103460019	200	40	180	76,73					
20	347,0	324,71	101460020	180	40	90	28,50	102460020	200	40	120	54,56	103460020	200	40	180	85,07					
21	363,0	340,82	101460021	180	40	90	30,36	102460021	200	40	120	59,87	103460021	200	40	180	93,89					
22	379,0	356,98	101460022	*180	40	90	32,31	102460022	*200	40	120	65,47										
23	396,0	373,08	101460023	*180	40	90	34,36	102460023	*200	40	120	71,35	103460023	*200	40	180	112,93					
24	412,0	389,18	101460024	*180	40	90	36,50	102460024	*200	40	120	77,52										
25	428,0	405,33	101460025	*180	40	90	38,74	102460025	*200	40	120	83,66	103460025	*200	40	180	133,86					
26	444,0	421,44	101460026	*180	40	90	41,07	102460026	*200	40	120	90,69										
27	460,0	437,59																				
28	476,0	453,69	101460028	*180	40	90	46,01	102460028	*200	40	120	104,99										
29	492,0	469,85																				
30	508,0	486,00	101460030	*180	40	90	51,34	102460030	*200	40	120	120,41	103460030	*200	40	180	194,42					
31	525,0	502,13																				
32	541,0	518,27	101460032	*200	40	90	59,89															
33	557,0	534,42																				
34	573,0	550,56																				
35	589,0	566,71	101460035	*200	40	90	69,16	102460035	*200	40	120	163,85	103460035	*200	40	180	267,49					
36	605,0	582,86																				
37	622,0	599,01																				
38	638,0	615,16	101460038	*200	40	90	79,28	102460038	*200	40	120	193,33	103460038	*200	40	180	316,22					
40	670,0	647,47	101460040	*200	40	90	86,50	102460040	*200	40	120	214,39										
45	751,0	728,24	101460045	*218	40	123	118,87	102460045	*220	40	148	282,32	103460045	*220	40	207	456,64					
50	832,0	809,04	101460050	*218	40	123	140,96	102460050	*220	40	148	346,95	103460050	*220	40	207	564,27					
57	945,0	922,16	101460057	*218	40	123	175,86	102460057	*220	40	148	449,27	103460057	*220	40	207	734,72					
60	993,0	970,65	101460060	*218	40	123	192,24															
76	1252,0	1229,27	101460076	*218	40	123	294,00	102460076	*220	40	148	796,60	103460076	*238	40	216	1319,64					



PIGNONI PER CATENA A RULLI CON TEMPERA INDUZIONE SUI DENTI SPROCKETS FOR ROLLER CHAINS WITH HARDENED TEETH

3/8" x 7/32"
9,525 x 5,71 mm
Rullo 6,35 mm
06B - 1 - 2

B1	B2	B3	b1	C	r3
5,3	15,4		5,2	1	10

Materiale: Acciaio C-45

Z	de	dp	semplici				doppi					
			codice	dm	D1	A	Kg.	codice	dm	D2	A	Kg.
13	43,5	39,80	191330013	28	8	25	0,13	192330013	28	10	30	0,16
14	46,5	42,80	191330014	31	8	25	0,16	192330014	31	10	30	0,20
15	49,5	45,81	191330015	34	8	25	0,19	192330015	34	10	30	0,24
16	52,5	48,82	191330016	37	10	28	0,24	192330016	37	12	30	0,27
17	55,5	51,83	191330017	40	10	28	0,28	192330017	40	12	30	0,32
18	58,6	54,85	191330018	43	10	28	0,33	192330018	43	12	30	0,38
19	61,6	57,87	191330019	45	10	28	0,36	192330019	46	12	30	0,42
20	64,6	60,89	191330020	46	10	28	0,39	192330020	49	12	30	0,48
21	67,6	63,91	191330021	48	12	28	0,42	192330021	52	16	30	0,52
22	70,6	66,93	191330022	50	12	28	0,46	192330022	55	16	30	0,58
23	73,7	69,95	191330023	52	12	28	0,50	192330023	58	16	30	0,64
24	76,7	72,97	191330024	54	12	28	0,54	192330024	61	16	30	0,71
25	79,7	76,00	191330025	57	12	28	0,60	192330025	64	16	30	0,79
30	94,8	91,12	191330030	60	12	30	0,72	192330030	79	16	30	1,20

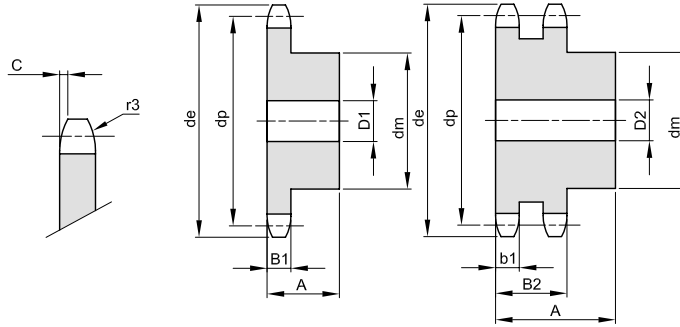

PIGNONI PER CATENA A RULLI CON TEMPERA INDUZIONE SUI DENTI SPROCKETS FOR ROLLER CHAINS WITH HARDENED TEETH

1/2" x 5/16"
12,7 x 7,75 mm
Rullo 8,51 mm
08B - 1 - 2

B1	B2	B3	b1	C	r3
7,2	21		7	1,3	13

Materiale: Acciaio C-45

Z	de	dp	semplici				doppi					
			codice	dm	D1	A	Kg.	codice	dm	D2	A	Kg.
12	53,9	49,07	191340012	33	10	28	0,21	192340012	35	12	35	0,30
13	57,9	53,06	191340013	37	10	28	0,26	192340013	38	12	35	0,36
14	61,9	57,07	191340014	41	10	28	0,32	192340014	42	12	35	0,44
15	65,9	61,09	191340015	45	10	28	0,38	192340015	46	12	35	0,52
16	69,9	65,10	191340016	50	12	28	0,46	192340016	50	16	38	0,63
17	74,0	69,11	191340017	52	12	28	0,51	192340017	54	16	38	0,73
18	78,0	73,14	191340018	56	12	28	0,59	192340018	58	16	38	0,85
19	82,0	77,16	191340019	60	12	28	0,67	192340019	62	16	38	0,97
20	86,0	81,19	191340020	64	12	28	0,76	192340020	66	16	38	1,10
21	90,1	85,22	191340021	68	14	28	0,85	192340021	70	16	40	1,29
22	94,1	89,24	191340022	70	14	28	0,91	192340022	70	16	40	1,37
23	98,1	93,27	191340023	70	14	28	0,95	192340023	70	16	40	1,46
24	102,1	97,29	191340024	70	14	28	0,98	192340024	75	16	40	1,64
25	106,2	101,33	191340025	70	14	28	1,01	192340025	80	16	40	1,82
30	126,3	121,50	191340030	80	16	30	1,46	192340030	100	16	40	2,79

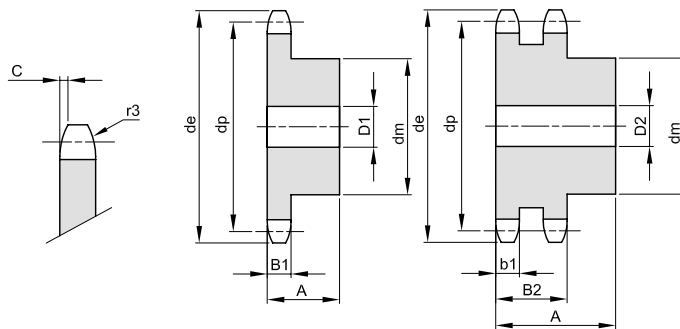



PIGNONI PER CATENA A RULLI CON TEMPERA INDUZIONE SUI DENTI SPROCKETS FOR ROLLER CHAINS WITH HARDENED TEETH

5/8" x 3/8"
15,875 x 9,65 mm
Rullo 10,16 mm
10B - 1 - 2

B1	B2	B3	b1	C	r3
9,1	25,5		9	1,6	16

Materiale: Acciaio C-45

Z	de	dp	semplici					doppi				
			codice	dm	D1	A	Kg.	codice	dm	D2	A	Kg.
12	68,2	61,34	191350012	42	12	30	0,37	192350012	44	16	40	0,55
13	73,2	66,32	191350013	47	12	30	0,46	192350013	49	16	40	0,68
14	78,2	71,34	191350014	52	12	30	0,56	192350014	54	16	40	0,82
15	83,2	76,36	191350015	57	12	30	0,67	192350015	59	16	40	0,97
16	88,3	81,37	191350016	60	12	30	0,76	192350016	64	16	45	1,26
17	93,3	86,39	191350017	60	12	30	0,88	192350017	69	16	45	1,46
18	98,3	91,42	191350018	70	14	30	1,01	192350018	74	16	45	1,67
19	103,3	96,45	191350019	70	14	30	1,15	192350019	79	16	45	1,90
20	108,4	101,49	191350020	75	14	30	1,21	192350020	84	16	45	2,14
21	113,4	106,52	191350021	75	16	30	1,35	192350021	85	16	45	2,27
22	118,4	111,55	191350022	80	16	30	1,41	192350022	90	16	45	2,54
23	123,5	116,58	191350023	80	16	30	1,47	192350023	95	16	45	2,82
24	128,5	121,62	191350024	80	16	30	1,54	192350024	100	16	45	3,11
25	133,6	126,66	191350025	80	16	30	1,60	192350025	105	16	45	3,15
30	158,8	151,87	191350030	90	20	35	2,41	192350030	120	20	45	4,87

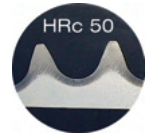
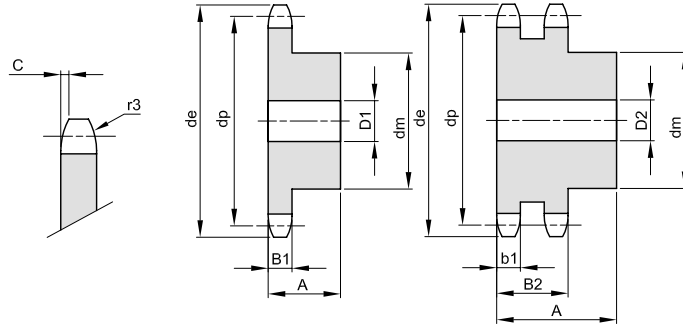

PIGNONI PER CATENA A RULLI CON TEMPERA INDUZIONE SUI DENTI SPROCKETS FOR ROLLER CHAINS WITH HARDENED TEETH

3/4" x 7/16"
19,50 x 11,68 mm
Rullo 12,07 mm
12B - 1 - 2

B1	B2	B3	b1	C	r3
11,1	30,3		10,8	2	19

Materiale: Acciaio C-45

Z	de	dp	semplici					doppi				
			codice	dm	D1	A	Kg.	codice	dm	D2	A	Kg.
12	81,8	73,60	191360012	52	16	35	0,65	192360012	53	16	50	1,02
13	87,8	79,59	191360013	58	16	35	0,80	192360013	59	16	50	1,25
14	93,8	85,61	191360014	64	16	35	0,97	192360014	65	16	50	1,46
15	99,8	91,63	191360015	70	16	35	1,16	192360015	71	16	50	1,74
16	105,8	97,65	191360016	75	16	35	1,34	192360016	77	20	50	2,03
17	111,9	103,67	191360017	80	16	35	1,53	192360017	83	20	50	2,36
18	117,9	109,71	191360018	80	16	35	1,62	192360018	89	20	50	2,70
19	123,9	115,75	191360019	80	16	35	1,70	192360019	95	20	50	3,07
20	130,0	121,78	191360020	80	16	35	1,80	192360020	100	20	50	3,43
21	136,0	127,82	191360021	90	20	40	2,35	192360021	100	20	50	3,69
22	142,0	133,86	191360022	90	20	40	2,46	192360022	100	20	50	3,97
23	148,1	139,90	191360023	90	20	40	2,56	192360023	110	20	50	4,51
24	154,1	145,94	191360024	90	20	40	2,68	192360024	110	20	50	4,81
25	160,2	152,00	191360025	90	20	40	2,80	192360025	120	20	50	5,41
30	190,4	182,25	191360030	95	20	40	3,63	192360030	120	20	50	7,19

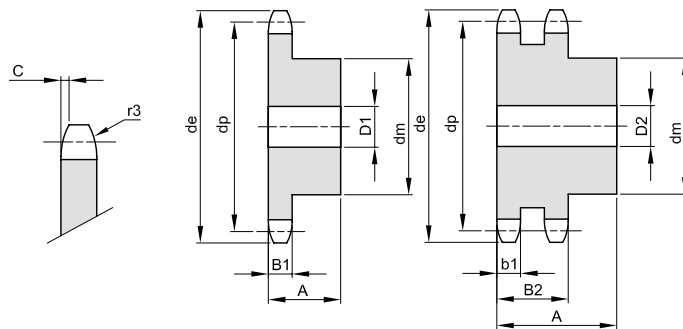



PIGNONI PER CATENA A RULLI CON TEMPERA INDUZIONE SUI DENTI SPROCKETS FOR ROLLER CHAINS WITH HARDENED TEETH

1" x 17,02"
25,4 x 17,02 mm
 Rullo 15,88 mm
16B - 1 - 2

B1	B2	B3	b1	C	r3
16,2	47,7		15,8	2,5	26

Materiale: Acciaio C-45

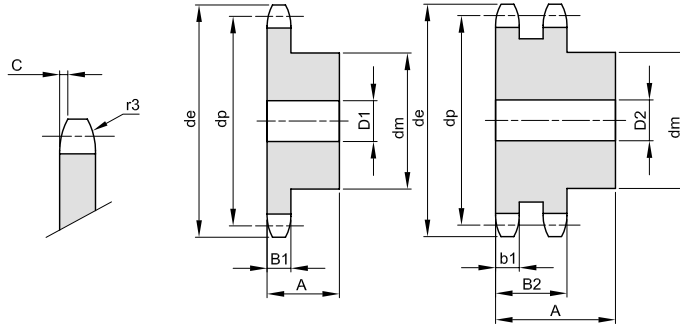

Z	de	dp	semplici					doppi				
			codice	dm	D1	A	Kg.	codice	dm	D2	A	Kg.
12	109,7	98,14	191380012	69	16	40	1,43	192380012	72	20	70	2,60
13	117,7	106,12	191380013	78	16	40	1,77	192380013	80	20	70	3,18
14	125,7	114,15	191380014	84	16	40	2,08	192380014	88	20	70	3,82
15	133,7	122,17	191380015	92	16	40	2,46	192380015	96	20	70	4,51
16	141,8	130,20	191380016	100	20	45	3,14	192380016	104	20	70	5,17
17	149,8	138,22	191380017	100	20	45	3,33	192380017	112	20	70	5,98
18	157,8	146,28	191380018	100	20	45	3,56	192380018	120	20	70	6,84
19	165,9	154,33	191380019	100	20	45	3,78	192380019	128	20	70	7,76
20	173,9	162,38	191380020	100	20	45	4,03	192380020	130	20	70	8,52
21	182,0	170,43	191380021	110	20	50	5,01	192380021	130	25	70	9,24
22	190,1	178,48	191380022	110	20	50	5,28	192380022	130	25	70	10,00
23	198,1	186,53	191380023	110	20	50	5,56	192380023	130	25	70	10,80
24	206,2	194,59	191380024	110	20	50	5,86	192380024	130	25	70	11,64
25	214,2	202,66	191380025	110	20	50	6,16	192380025	130	25	70	12,52
30	254,6	243,00	191380030	120	20	50	8,38	192380030	130	25	70	17,48





PIGNONI PER BUSSOLA CONICA - DIN 8187 - ISO 606

SPROCKETS FOR TAPER BUSHES - DIN 8187 - ISO 606

3/8" x 7/32"
9,525 x 5,72 mm
Rullo 6,35 mm
06B - 1 - 2 - 3

B1	B2	B3	b1	C	r3
5,3	15,4	25,6	5,2	1	10

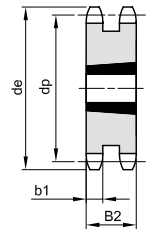
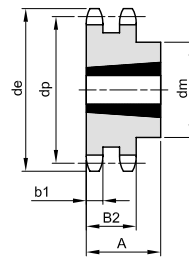
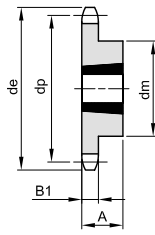
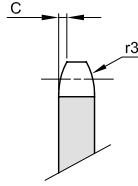

1

2

3

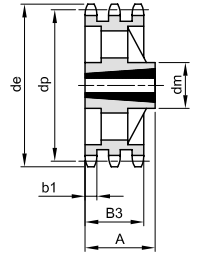
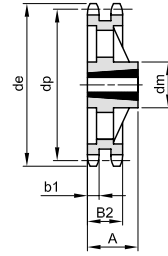
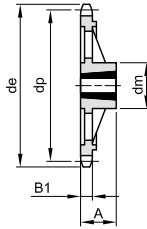
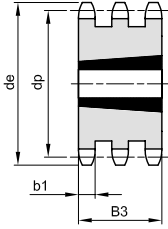
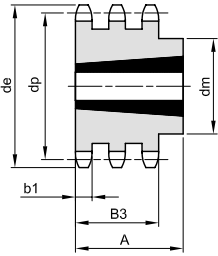

4

5

6

7

8

Materiale: Acciaio C45 / *Materiale: Ghisa EN-GJL-200

Z	de	dp	semplici						doppi					tripli						
			codice	dm	A	Bussola	Tipo	Kg.	codice	dm	A	Bussola	Tipo	Kg.	codice	dm	A	Bussola	Tipo	Kg.
17	55,5	51,83	381330017	45	22	1008	1	0,11	382330017	41	22	1008	2	0,11	383330017	25,6	1008	5	0,15	
18	58,6	54,85	381330018	45	22	1008	1	0,14	382330018	43	22	1008	2	0,15						
19	61,6	57,86	381330019	45	22	1008	1	0,15	382330019	46	22	1008	2	0,18	383330019	25,6	1008	5	0,24	
20	64,6	60,89	381330020	46	22	1008	1	0,16	382330020	48	22	1008	2	0,22						
21	67,6	63,90	381330021	46	22	1008	1	0,18	382330021	49	22	1008	2	0,16	383330021	25,6	1008	5	0,34	
22	70,6	66,93	381330022	55	22	1108	1	0,25	382330022	52	22	1108	2	0,28						
23	73,7	69,95	381330023	63	25	1210	1	0,27	382330023	59	25	1210	2	0,27	383330023	25,6	1210	5	0,30	
24	76,7	72,97	381330024	63	25	1210	1	0,30	382330024	61	25	1210	2	0,32						
25	79,7	75,99	381330025	63	25	1210	1	0,32	382330025	64	25	1210	2	0,37	383330025	25,6	1210	5	0,41	
26	82,7	79,02	381330026	63	25	1210	1	0,33	382330026	65	25	1210	2	0,44						
27	85,7	82,04	381330027	63	25	1210	1	0,34	382330027	70	25	1210	2	0,50	383330027	25,6	1210	5	0,55	
28	88,8	85,07	381330028	63	25	1210	1	0,37	382330028	70	25	1210	2	0,57						
30	94,8	91,12	381330030	63	25	1210	1	0,39	382330030	75	25	1210	2	0,68	383330030	79	38	1615	4	0,88
38	119,0	115,34	381330038	70	25	1210	1	0,65	382330038	80	25	1610	2	1,03	383330038	90	38	1615	4	1,75
45	141,1	136,54	381330045	70	25	1210	1	1,01												
57*	177,5	172,91	381330057	83	25	1210	6	1,34	382330057	90	25	1610	7	1,16						
76*	235,1	230,49	381330076	83	25	1210	6	1,84	382330076	90	25	1610	7	2,19						



PIGNONI PER BUSSOLA CONICA - DIN 8187 - ISO 606

SPROCKETS FOR TAPER BUSHES - DIN 8187 - ISO 606

1/2" x 5/16"
12,7 x 7,75 mm
 Rullo 8,51 mm
08B - 1 - 2 - 3

B1	B2	B3	b1	C	r3
7,2	21	34,9	7	1,3	13

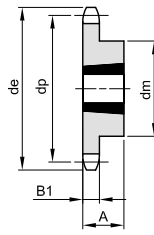
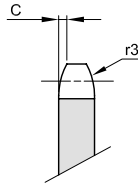

1

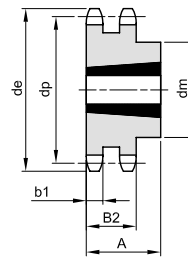

2

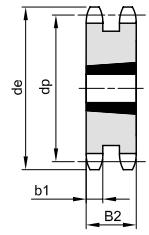

3

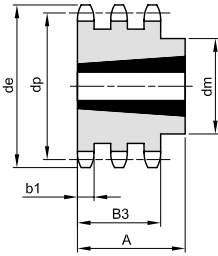

4

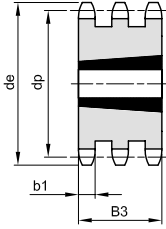

5

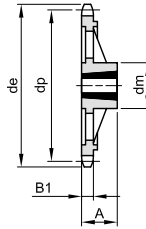

6

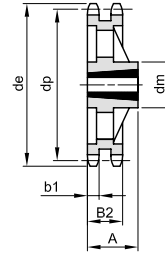

7

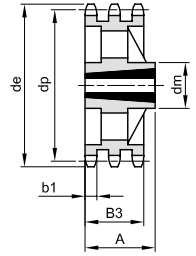

8

Materiale: Acciaio C45 / *Materiale: Ghisa EN-GJL-200

Z	de	dp	semplici					doppi					tripli							
			codice	dm	A	Bussola	Tipo	Kg.	codice	dm	A	Bussola	Tipo	Kg.	codice	dm	A	Bussola	Tipo	Kg.
15	65,9	61,09	381340015	45	22	1008	1	0,16	382340015	46	22	1008	2	0,22	383340015	34,9	1008	5	0,36	
16	69,9	65,10	381340016	50	22	1108	1	0,20	382340016	50	22	1108	2	0,22						
17	74,0	69,11	381340017	60	25	1210	1	0,22	382340017	56	25	1210	2	0,23	383340017	34,9	1210	5	0,35	
18	78,0	73,14	381340018	60	25	1210	1	0,27	382340018	60	25	1210	2	0,30						
19	82,0	77,16	381340019	63	25	1210	1	0,33	382340019	62	25	1210	2	0,38	383340019	62	38	1215	4	0,61
20	86,0	81,19	381340020	67	25	1610	1	0,27	382340020	66	25	1610	2	0,32						
21	90,1	85,22	381340021	71	25	1610	1	0,36	382340021	70	25	1610	2	0,50	383340021	70	38	1615	4	0,65
22	94,1	89,24	381340022	71	25	1610	1	0,36	382340022	76	25	1610	2	0,55						
23	98,1	93,27	381340023	76	25	1610	1	0,50	382340023	79	25	1610	2	0,62	383340023	70	38	1615	4	0,93
24	102,1	97,29	381340024	76	25	1610	1	0,53	382340024	84	32	2012	2	0,68						
25	106,2	101,33	381340025	76	25	1610	1	0,56	382340025	87	32	2012	2	0,72	383340025	34,9	2012	5	0,85	
26	110,2	105,36	381340026	76	25	1610	1	0,60	382340026	87	32	2012	2	0,82						
27	114,2	109,40	381340027	76	25	1610	1	0,63	382340027	87	32	2012	2	0,92	383340027	34,9	2012	5	1,18	
28	118,3	113,42	381340028	90	32	2012	1	0,77	382340028	87	32	2012	2	1,10						
30	126,3	121,50	381340030	90	32	2012	1	0,91	382340030	87	32	2012	2	1,24	383340030	34,9	2012	5	1,73	
38	158,6	153,80	381340038	90	32	2012	1	1,25	382340038	100	32	2012	2	2,50	383340038	34,9	2012	5	3,53	
45	188,6	182,07	381340045	111	32	2012	1	1,68												
57*	237,1	230,54	381340057	111	32	2012	6	2,78	382340057	111	32	2012	7	3,64						
76*	313,9	307,33	381340076	111	32	2012	6	3,81	382340076	111	32	2012	7	5,09						



PIGNONI PER BUSSOLA CONICA - DIN 8187 - ISO 606

SPROCKETS FOR TAPER BUSHES - DIN 8187 - ISO 606

5/8" x 3/8"
15,875 x 9,65 mm
 Rullo 10,16 mm
10B - 1 - 2 - 3

B1	B2	B3	b1	C	r3
9,1	25,5	42,1	9	1,6	16

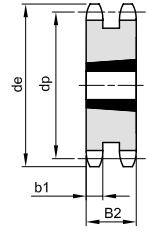
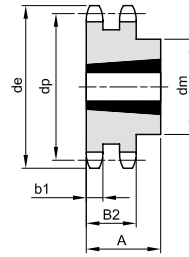
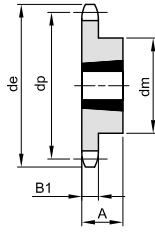
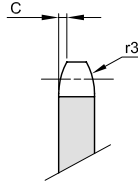

1

2

3

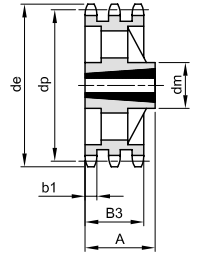
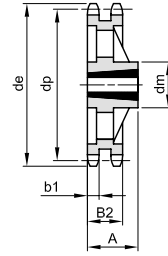
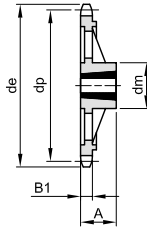
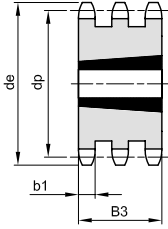
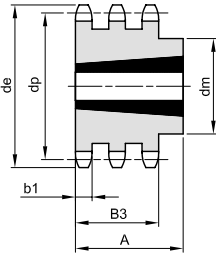

4

5

6

7

8

Materiale: Acciaio C45 / *Materiale: Ghisa EN-GJL-200

Z	de	dp	semplici					doppi					tripli							
			codice	dm	A	Bussola	Tipo	Kg.	codice	dm	A	Bussola	Tipo	Kg.	codice	dm	A	Bussola	Tipo	Kg.
13	73,2	66,33	381350013	47	22	1008	1	0,23												
14	78,2	71,34	381350014	52	22	1108	1	0,27												
15	83,2	76,35	381350015	60	25	1210	1	0,30	382350015	25,5	1210	3	0,38	383350015	42,1	1215	5	0,63		
16	88,3	81,37	381350016	63	25	1210	1	0,38	382350016	25,5	1610	3	0,42							
17	93,3	86,39	381350017	71	25	1610	1	0,38	382350017	25,5	1610	3	0,47	383350017	42,1	1215	5	1,01		
18	98,3	91,42	381350018	71	25	1610	1	0,43	382350018	25,5	1610	3	0,60							
19	103,3	96,44	381350019	75	25	1610	1	0,54	382350019	25,5	1610	3	0,72	383350019	42,1	1615	5	1,19		
20	108,4	101,49	381350020	76	25	1610	1	0,61	382350020	25,5	1610	3	0,87							
21	113,4	106,51	381350021	76	25	1610	1	0,65	382350021	25,5	1610	3	1,01	383350021	42,1	1615	5	1,66		
22	118,4	111,55	381350022	76	25	1610	1	0,72	382350022	25,5	1610	3	1,18							
23	123,5	116,58	381350023	76	25	1610	1	0,77	382350023	25,5	1610	3	1,35	383350023	42,1	2012	5	1,78		
24	128,5	121,62	381350024	90	32	2012	1	0,98	382350024	90	32	2012	2	1,45						
25	133,6	126,66	381350025	90	32	2012	1	1,05	382350025	90	32	2012	2	1,55	383350025	105	44	2517	4	1,81
26	138,6	131,70	381350026	90	32	2012	1	1,11	382350026	90	32	2012	2	1,75						
27	143,6	136,74	381350027	90	32	2012	1	1,17	382350027	90	32	2012	2	1,98	383350027	110	44	2517	4	2,45
28	148,7	141,78	381350028	90	32	2012	1	1,29	382350028	90	32	2012	2	2,30						
30	158,8	151,87	381350030	90	32	2012	1	1,40	382350030	90	32	2012	2	2,63	383350030	120	44	2517	4	3,54
38	199,1	192,23	381350038	100	32	2012	1	2,43												
45	236,0	227,58	381350045	111	32	2012	1	3,55												
57*	296,6	288,18	381350057	111	32	2012	6	4,28												
76*	392,5	384,16	381350076	111	32	2012	6	5,95												



PIGNONI PER BUSSOLA CONICA - DIN 8187 - ISO 606

SPROCKETS FOR TAPER BUSHES - DIN 8187 - ISO 606

3/4" x 7/16"
19,05 x 11,68 mm
 Rullo 12,07 mm
12B - 1 - 2 - 3

B1	B2	B3	b1	C	r3
11,1	30,3	49,8	10,8	2	19

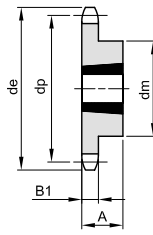
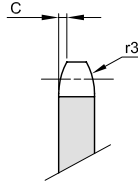

1

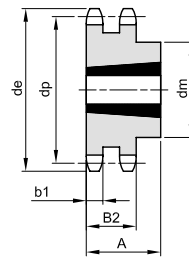

2

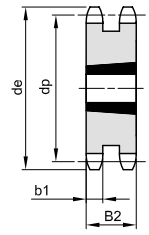

3

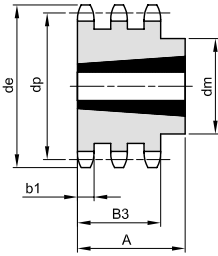

4

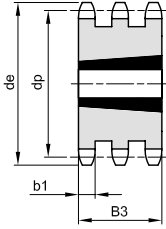

5

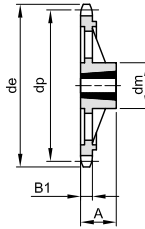

6

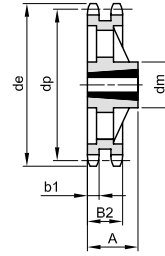

7

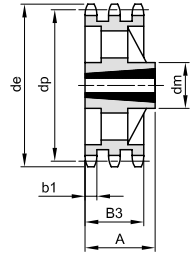

8

Materiale: Acciaio C45 / *Materiale: Ghisa EN-GJL-200

Z	de	dp	semplici					doppi					tripli							
			codice	dm	A	Bussola	Tipo	Kg.	codice	dm	A	Bussola	Tipo	Kg.	codice	dm	A	Bussola	Tipo	Kg.
13	87,8	79,60	381360013	60	25	1210	1	0,35												
14	93,8	85,61	381360014	67	25	1610	1	0,40												
15	99,8	91,62	381360015	70	25	1610	1	0,44	382360015	30,3	1610	3	0,68	383360015	49,8	1615	5	1,11		
16	105,8	97,65	381360016	71	25	1610	1	0,53	382360016	30,3	1610	3	0,89							
17	111,9	103,67	381360017	76	25	1610	1	0,66	382360017	30,3	1610	3	1,14	383360017	49,8	1615	5	1,75		
18	117,9	109,71	381360018	90	32	2012	1	0,86	382360018	90	32	2012	2	1,18						
19	123,9	115,73	381360019	90	32	2012	1	0,94	382360019	90	32	2012	2	1,24	383360019	49,8	2012	5	1,99	
20	130,0	121,78	381360020	90	32	2012	1	1,04	382360020	108	44	2517	2	1,40						
21	136,0	127,81	381360021	102	44	2517	1	1,24	382360021	108	44	2517	2	1,68	383360021	49,8	2517	5	2,09	
22	142,0	133,86	381360022	108	44	2517	1	1,60	382360022	108	44	2517	2	1,99						
23	148,1	139,90	381360023	108	44	2517	1	1,70	382360023	108	44	2517	2	2,24	383360023	49,8	2517	5	3,00	
24	154,1	145,94	381360024	108	44	2517	1	1,81	382360024	108	44	2517	2	2,54						
25	160,2	151,99	381360025	108	44	2517	1	1,93	382360025	108	44	2517	2	2,87	383360025	49,8	2517	5	3,98	
26	166,2	158,04	381360026	108	44	2517	1	2,04	382360026	108	44	2517	2	3,17						
27	172,3	164,09	381360027	108	44	2517	1	2,14	382360027	108	44	2517	2	3,55	383360027	140	51	3020	4	3,90
28	178,3	170,13	381360028	108	44	2517	1	2,37	382360028	108	44	2517	2	4,10						
30	190,4	182,24	381360030	108	44	2517	1	2,60	382360030	108	44	2517	2	4,62	383360030	140	51	3020	4	5,64
38	238,9	230,69	381360038	108	44	2517	1	3,93	382360038	140	51	3020	2	8,11	383360038	140	51	3020	4	11,58
45	283,2	273,10	381360045	124	44	2517	1	5,52												
57*	355,9	345,81	381360057	124	44	2517	6	6,48	382360057	160	51	3020	7	10,28	383360057	160	51	3020	8	13,23
76*	471,1	460,99	381360076	124	44	2517	6	9,71	382360076	160	51	3020	7	15,24						



PIGNONI PER BUSSOLA CONICA - DIN 8187 - ISO 606

SPROCKETS FOR TAPER BUSHES - DIN 8187 - ISO 606

1" x 17,02 mm
25,4 x 17,02 mm
Rullo 15,88 mm
16B - 1 - 2 - 3

B1	B2	B3	b1	C	r3
16,2	47,7	79,6	15,8	2,5	26

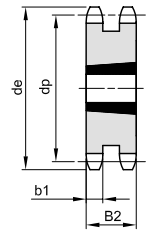
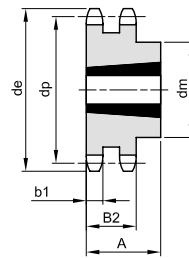
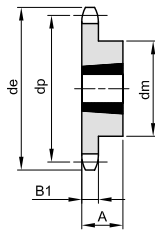
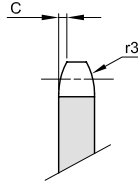

1

2

3

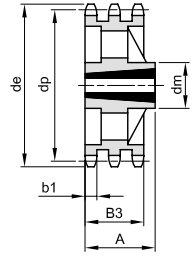
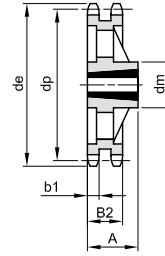
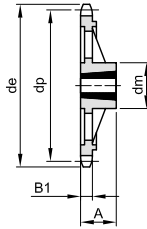
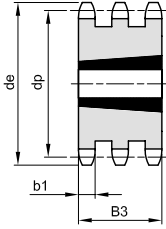
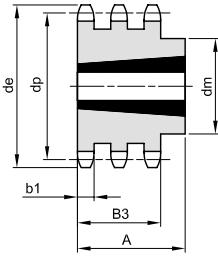

4

5

6

7

8

Materiale: Acciaio C45 / *Materiale: Ghisa EN-GJL-200

Z	de	dp	semplici					doppi					tripli							
			codice	dm	A	Bussola	Tipo	Kg.	codice	dm	A	Bussola	Tipo	Kg.	codice	dm	A	Bussola	Tipo	Kg.
13	117,7	106,13	381380013	73	38	1615	1	0,98												
14	125,7	114,15	381380014	75	38	1615	1	1,14												
15	133,7	122,16	381380015	76	38	1615	1	1,30	382380015	47,7	2012	3	2,11							
16	141,8	130,20	381380016	90	32	2012	1	1,40	382380016	47,7	2517	3	2,25							
17	149,8	138,23	381380017	90	32	2012	1	1,59	382380017	47,7	2517	3	2,53	383380017	79,6	2517	5	4,29		
18	157,8	146,28	381380018	108	44	2517	1	2,10	382380018	47,7	2517	3	3,10							
19	165,9	154,31	381380019	108	44	2517	1	2,29	382380019	47,7	2517	3	3,80	383380019	79,6	3030	5	4,36		
20	173,9	162,38	381380020	110	44	2517	1	2,60	382380020	47,7	2517	3	4,10							
21	182,0	170,42	381380021	110	44	2517	1	2,81	382380021	140	51	3020	2	4,15	383380021	79,6	3030	5	6,69	
22	190,1	178,48	381380022	110	44	2517	1	3,10	382380022	140	51	3020	2	4,90						
23	198,1	186,53	381380023	110	44	2517	1	3,38	382380023	140	51	3020	2	5,69	383380023	159	89	3535	4	7,80
24	206,2	194,59	381380024	110	44	2517	1	3,70	382380024	140	51	3020	2	6,00						
25	214,2	202,66	381380025	110	44	2517	1	3,97	382380025	140	51	3020	2	6,38	383380025	175	89	3535	4	10,93
26	222,3	210,72	381380026	110	44	2517	1	4,26	382380026	140	51	3020	2	7,80						
27	230,4	218,79	381380027	110	44	2517	1	4,55	382380027	140	51	3020	2	9,27	383380027	175	89	3535	4	14,06
28	238,4	226,85	381380028	110	44	2517	1	5,26	382380028	140	51	3020	2	10,25						
30	254,6	242,99	381380030	120	44	2517	1	5,97	382380030	140	76	3030	2	13,50	383380030	175	89	3535	4	19,10
38	319,2	307,59	381380038	160	51	3020	1	8,73	382380038	*160	76	3030	7	14,94	383380038	*175	89	3535	8	21,65
45	377,9	364,12	381380045	160	51	3020	1	12,49	382380045	*160	76	3030	7	18,00	383380045	*175	89	3535	8	28,10
57*	474,9	461,07	381380057	160	51	3020	6	13,87	382380057	175	89	3535	7	22,00	383380057	216	102	4040	8	40,50
76*	628,4	614,65	381380076	160	51	3020	6	22,63	382380076	175	89	3535	7	37,00	383380076	216	102	4040	8	53,30



PIGNONI PER BUSSOLA CONICA - DIN 8187 - ISO 606

SPROCKETS FOR TAPER BUSHES - DIN 8187 - ISO 606

1"1/4 x 3/4"
31,75 x 19,56 mm
 Rullo 19,05 mm
20B - 1 - 2 - 3

B1	B2	B3	b1	C	r3
18,5	54,6	91	18,2	3,5	32

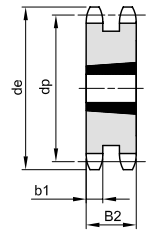
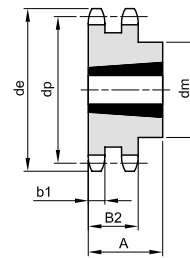
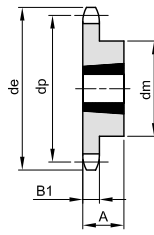
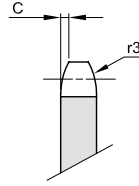

1

2

3

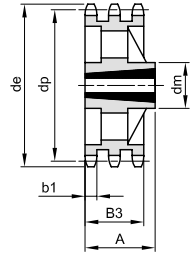
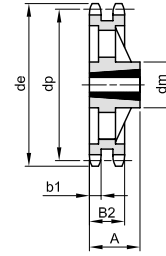
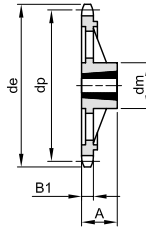
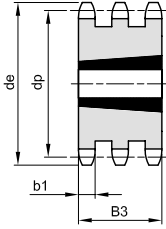
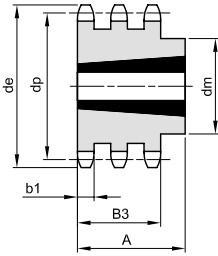

4

5

6

7

8

Materiale: Acciaio C45 / *Materiale: Ghisa EN-GJL-200

Z	de	dp	semplici					doppi					tripli							
			codice	dm	A	Bussola	Tipo	Kg.	codice	dm	A	Bussola	Tipo	Kg.	codice	dm	A	Bussola	Tipo	Kg.
12	137,0	122,68	381400012	90	32	1615	1	1,60												
13	147,5	132,65	381400013	90	32	2012	1	1,50	382400013	54,6	2517	3	2,40							
14	157,6	142,68	381400014	110	44	2517	1	2,10												
15	167,7	152,72	381400015	110	44	2517	1	2,40	382400015	54,6	2517	3	4,15	383400015	91	3020	5	4,43		
16	177,7	162,75	381400016	110	44	2517	1	2,80												
17	187,7	172,78	381400017	110	44	2517	1	3,10	382400017	54,6	2517	3	6,10	383400017	91	3030	5	7,39		
18	197,8	182,85	381400018	110	44	2517	1	3,45												
19	207,9	192,91	381400019	110	44	2517	1	3,80	382400019	140	76	3030	2	8,24	383400019	91	3030	5	11,65	
20	217,9	202,98	381400020	110	44	2517	1	4,35												
21	228,0	213,04	381400021	120	44	2517	1	5,15	382400021	140	76	3030	2	10,80	383400021	91	3535	5	12,80	
23	248,2	233,17	381400023	120	44	2517	1	6,15	382400023	140	76	3030	2	13,50	383400023	91	3535	5	17,38	
25	268,4	253,33	381400025	120	44	2517	1	7,20	382400025	140	76	3030	2	16,60	383400025	91	3535	5	22,40	
30	318,7	303,75	381400030	160	51	3020	1	11,50	382400030	160	76	3030	2	26,50	383400030	91	3535	5	36,50	
38*	399,4	384,49	381400038	160	51	3020	6	11,65	382400038	160	76	3030	7	21,00	383400038	178	91	3535	8	28,00
57*	592,3	576,36	381400057	160	51	3020	6	21,00	382400057	175	89	3535	7	35,00	383400057	216	102	4040	8	42,00
76*	784,3	768,32	381400076	160	51	3020	6	24,00	382400076	175	89	3535	7	50,00	383400076	260	114	4545	8	85,00



PIGNONI PER BUSSOLA CONICA - DIN 8187 - ISO 606

SPROCKETS FOR TAPER BUSHES - DIN 8187 - ISO 606

1"1/2 x 1"
38,1 x 25,4 mm
 Rullo 25,4 mm
24B - 1 - 2 - 3

B1	B2	B3	b1	C	r3
24,1	72	120,3	23,6	4	38

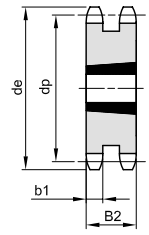
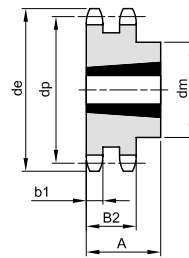
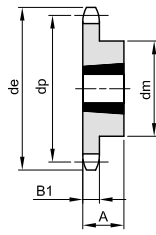
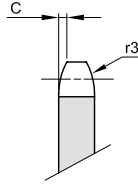

1

2

3

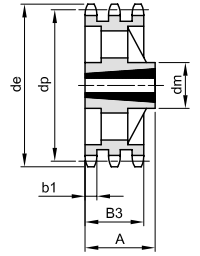
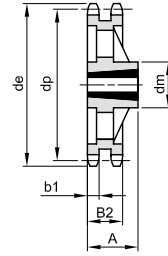
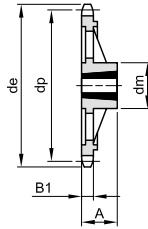
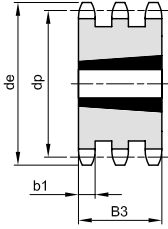
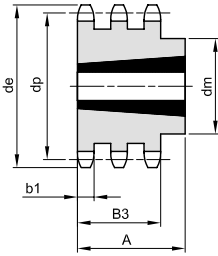

4

5

6

7

8

Materiale: Acciaio C45 / *Materiale: Ghisa EN-GJL-200

Z	de	dp	semplici					doppi					tripli							
			codice	dm	A	Bussola	Tipo	Kg.	codice	dm	A	Bussola	Tipo	Kg.	codice	dm	A	Bussola	Tipo	Kg.
11	149,0	135,21	381420011	90	32	2012	1	1,70												
12	161,0	147,22	381420012	90	32	2012	1	2,16												
13	173,0	159,18	381420013	110	44	2517	1	2,77	382420013	72	2517	3	5,30							
14	185,0	171,22	381420014	120	44	2517	1	3,60												
15	197,0	183,26	381420015	120	44	2517	1	4,20	382420015	72	3020	3	6,60	383420015	120,3	3030	5	11,09		
17	221,0	207,34	381420017	140	51	3020	1	5,40	382420017	72	3020	3	10,30	383420017	120,3	3030	5	17,10		
18	233,0	219,42	381420018	140	51	3020	1	6,10												
19	245,5	231,49	381420019	140	51	3020	1	6,85	382420019	160	76	3030	2	14,80	383420019	120,3	3535	5	20,87	
20	257,5	243,57	381420020	140	51	3020	1	7,76												
21	270,5	255,65	381420021	140	51	3020	1	8,52	382420021	160	76	3030	2	19,50	383420021	120,3	4040	5	25,50	
23	294,5	279,80	381420023	160	51	3020	1	11,31	382420023	175	89	3535	2	24,00	383420023	120,3	4040	5	34,00	
25	319,0	304,00	381420025	160	51	3020	1	13,33	382420025	175	89	3535	2	29,00	383420025	120,3	4040	5	43,00	
30	379,5	364,50	381420030	160	51	3020	1	19,00	382420030	175	89	3535	2	40,00	383420030	120,3	4040	5	72,00	
38*	476,5	461,39	381420038	160	76	3030	6	24,00	382420038	175	89	3535	7	44,00	383420038	215	120,3	4040	8	66,00
57*	707,5	691,63	381420057	160	76	3030	6	45,00	382420057	175	89	3535	7	72,00	383420057	260	120,3	4545	8	120,00
76*	939,0	921,98	381420076	175	89	3535	6	70,00	382420076	216	102	4040	7	107,00	383420076	260	120,3	4545	8	131,00



PIGNONI PER BUSSOLA CONICA TEMPERATI AD INDUZIONE - DIN 8187 - ISO 606
SPROCKETS FOR TAPER BUSHES WITH HARDENED TEETH - DIN 8187 - ISO 606

3/8" x 7/32"
9,525 x 5,72 mm
Rullo 6,35 mm
06B - 1

B1	C	r3
5,3	1	10

Materiale: Acciaio C45

Z	de	dp	codice	semplici			
				dm	A	bussola	Kg.
17	55,5	51,83	391330017	45	22	1008	0,11
19	61,6	57,86	391330019	45	22	1008	0,15
21	67,6	63,90	391330021	46	22	1008	0,18
23	73,7	69,95	391330023	63	25	1210	0,27
25	79,7	75,99	391330025	63	25	1210	0,32

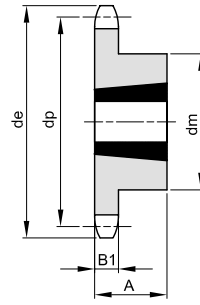
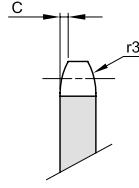

1/2" x 5/16"
12,7 x 7,75 mm
Rullo 8,51 mm
08B - 1

B1	C	r3
7,2	1,3	13

Materiale: Acciaio C45

Z	de	dp	codice	semplici			
				dm	A	bussola	Kg.
15	65,9	61,09	391340015	45	22	1008	0,16
17	74,0	69,11	391340017	60	25	1210	0,22
19	82,0	77,16	391340019	63	25	1210	0,33
21	90,1	85,22	391340021	71	25	1610	0,36
23	98,9	93,27	391340023	76	25	1610	0,50

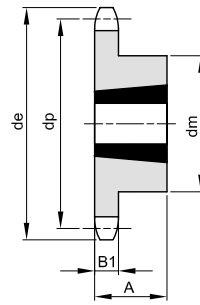
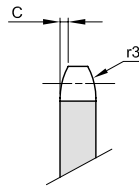

5/8" x 3/8"
15,875 x 9,65 mm
Rullo 10,16 mm
10B - 1

B1	C	r3
9,1	1,6	16

Materiale: Acciaio C45

Z	de	dp	codice	semplici			
				dm	A	bussola	Kg.
13	73,2	66,33	391350013	47	22	1008	0,23
15	83,2	76,35	391350015	60	25	1210	0,30
17	93,3	86,39	391350017	71	25	1610	0,38
19	103,3	96,44	391350019	75	25	1610	0,54
21	113,4	106,51	391350021	76	25	1610	0,65

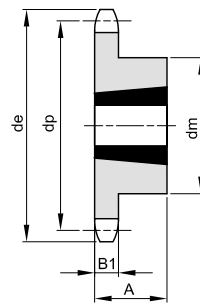
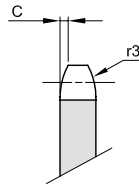

Z	de	dp	codice	semplici			
				dm	A	bussola	Kg.
27	85,7	82,04	391330027	63	25	1210	0,34
30	94,8	91,12	391330030	63	25	1210	0,39

Z	de	dp	codice	semplici			
				dm	A	bussola	Kg.
25	106,7	101,32	391340025	76	25	1610	0,56
27	114,8	109,39	391340027	76	25	1610	0,63
30	126,9	121,49	391340030	90	32	2012	0,91

Z	de	dp	codice	semplici			
				dm	A	bussola	Kg.
23	123,5	116,58	391350023	76	25	1610	0,77
25	133,6	126,66	391350025	90	32	2012	1,05
27	143,6	136,74	391350027	90	32	2012	1,17
30	158,8	151,87	391350030	90	32	2012	1,40



PIGNONI PER BUSSOLA CONICA TEMPERATI AD INDUZIONE - DIN 8187 - ISO 606
SPROCKETS FOR TAPER BUSHES WITH HARDENED TEETH - DIN 8187 - ISO 606

3/4" x 7/16"
19,05 x 11,68 mm
 Rullo 12,07 mm
12B - 1

B1	C	r3
11,1	2	19

Materiale: Acciaio C45

Z	de	dp	codice	semplici			
				dm	A	bussola	Kg.
13	87,8	79,60	391360013	60	25	1210	0,35
15	99,8	91,62	391360015	70	25	1610	0,44
17	111,9	103,67	391360017	76	25	1610	0,66
19	123,9	115,73	391360019	90	32	2012	0,94
21	136,0	127,81	391360021	102	44	2517	1,24

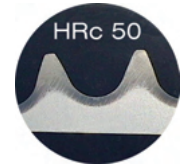
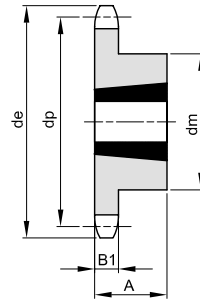
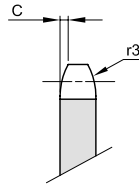

1" x 17,02 mm
25,4 x 17,02 mm
 Rullo 15,88 mm
16B - 1

B1	C	r3
16,2	2,5	26

Materiale: Acciaio C45

Z	de	dp	codice	semplici			
				dm	A	bussola	Kg.
15	133,7	122,16	391380015	76	38	1615	1,30
17	149,8	138,23	391380017	90	32	2012	1,59
19	165,9	154,31	391380019	108	44	2517	2,29
21	182,0	170,42	391380021	110	44	2517	2,81
23	198,1	186,53	391380023	110	44	2517	3,38

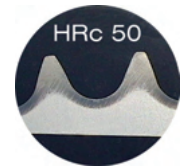
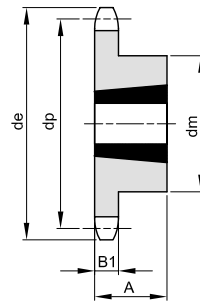
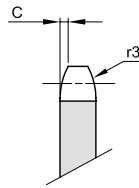

1"1/4 x 3/4"
31,75 x 19,56 mm
 Rullo 19,05 mm
20B - 1

B1	C	r3
18,5	3,5	32

Materiale: Acciaio C45

Z	de	dp	codice	semplici			
				dm	A	bussola	Kg.
15	167,7	152,72	391400015	110	44	2517	3,39
17	187,7	172,78	391400017	110	44	2517	5,07
19	207,9	192,91	391400019	110	44	2517	6,75
21	228,0	213,04	391400021	120	44	2517	7,70
23	248,2	233,17	391400023	120	44	2517	8,78

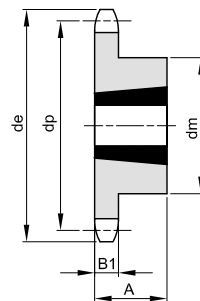
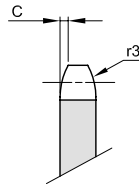

Z	de	dp	codice	semplici			
				dm	A	bussola	Kg.
23	148,1	139,90	391360023	108	44	2517	1,70
25	160,2	151,99	391360025	108	44	2517	1,93
27	172,3	164,09	391360027	108	44	2517	2,14
30	190,4	182,24	391360030	108	44	2517	2,60

Z	de	dp	codice	semplici			
				dm	A	bussola	Kg.
25	214,2	202,66	391380025	110	44	2517	3,97
27	230,4	218,79	391380027	110	44	2517	4,55
30	254,6	242,99	391380030	120	44	2517	5,97

Z	de	dp	codice	semplici			
				dm	A	bussola	Kg.
25	268,4	253,33	391400025	120	44	2517	9,50



PIGNONI SEMPLICI PER CATENE A RULLI IN ACCIAIO INOX - DIN 8187 - ISO 606
SIMPLEX SPROCKETS IN STAINLESS STEEL FOR ROLLER CHAINS - DIN 8187 - ISO 606

3/8" x 7/32"
9,525 x 5,72 mm
Rullo 6,35 mm
06B - 1

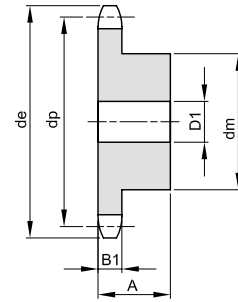
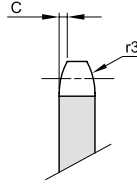

B1	C	r3
5,3	1	10

Materiale: INOX AISI 304 L

Z	de	dp	codice	dm	D1	A	Kg.
13	43,5	39,80	181330013	28	8	25	0,13
14	46,5	42,80	181330014	31	8	25	0,16
15	49,5	45,81	181330015	34	8	25	0,18
16	52,5	48,82	181330016	37	10	28	0,24
17	55,5	51,83	181330017	40	10	28	0,28
18	58,6	54,85	181330018	43	10	28	0,33
19	61,6	57,87	181330019	45	10	28	0,36

Z	de	dp	codice	dm	D1	A	Kg.
20	64,6	60,89	181330020	46	10	28	0,39
21	67,6	63,91	181330021	48	12	28	0,42
23	73,7	69,95	181330023	52	12	28	0,50
25	79,7	76,00	181330025	57	12	28	0,60
30	94,8	91,12	181330030	60	12	30	0,72

1/2" x 5/16"
12,7 x 7,75 mm
Rullo 8,51 mm
08B - 1

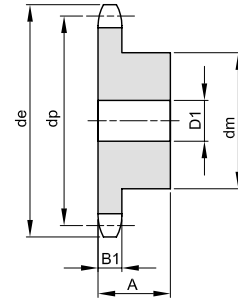
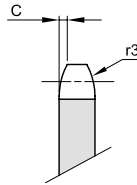

B1	C	r3
7,2	1,3	13

Materiale: INOX AISI 304 L

Z	de	dp	codice	dm	D1	A	Kg.
12	53,9	49,07	181340012	33	10	28	0,21
13	57,9	53,06	181340013	37	10	28	0,26
14	61,9	57,07	181340014	41	10	28	0,32
15	65,9	61,09	181340015	45	10	28	0,38
16	69,9	65,10	181340016	50	12	28	0,46
17	74,0	69,11	181340017	52	12	28	0,51
18	78,0	73,14	181340018	56	12	28	0,59

Z	de	dp	codice	dm	D1	A	Kg.
19	82,0	77,16	181340019	60	12	28	0,67
20	86,0	81,19	181340020	64	12	28	0,76
21	90,1	85,22	181340021	68	14	28	0,85
23	98,1	93,27	181340023	70	14	28	0,94
25	106,2	101,33	181340025	70	14	28	1,01
30	126,3	121,50	181340030	80	16	30	1,46

5/8" x 3/8"
15,875 x 9,65 mm
Rullo 10,16 mm
10B - 1

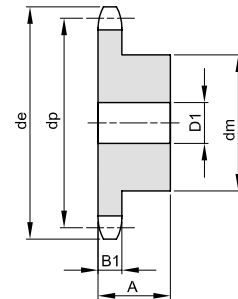
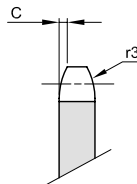

B1	C	r3
9,1	1,6	16

Materiale: INOX AISI 304 L

Z	de	dp	codice	dm	D1	A	Kg.
13	73,2	66,32	181350013	47	12	30	0,46
14	78,2	71,34	181350014	52	12	30	0,56
15	83,2	76,36	181350015	57	12	30	0,67
16	88,3	81,37	181350016	60	12	30	0,76
17	93,3	86,39	181350017	60	12	30	0,88
18	98,3	91,42	181350018	70	14	30	1,01
19	103,3	96,45	181350019	70	14	30	1,15

Z	de	dp	codice	dm	D1	A	Kg.
20	108,4	101,49	181350020	75	14	30	1,21
21	113,4	106,52	181350021	75	16	30	1,35
23	123,5	116,58	181350023	80	16	30	1,47
25	133,6	126,66	181350025	80	16	30	1,60
30	158,8	151,87	181350030	90	20	35	2,41



PIGNONI SEMPLICI PER CATENE A RULLI IN ACCIAIO INOX - DIN 8187 - ISO 606
SIMPLEX SPROCKETS IN STAINLESS STEEL FOR ROLLER CHAINS - DIN 8187 - ISO 606

3/4" x 7/16"
19,05 x 11,68 mm
 Rullo 12,07 mm
12B - 1

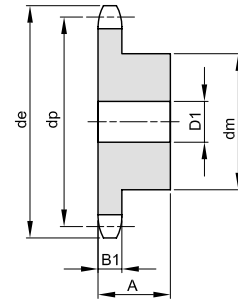
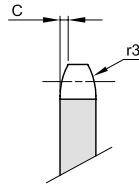

B1	C	r3
11,1	2	19

Materiale: INOX AISI 304 L

Z	de	dp	codice	dm	D1	A	Kg.
13	87,8	79,59	181360013	58	16	35	0,80
14	93,8	85,61	181360014	64	16	35	0,97
15	99,8	91,63	181360015	70	16	35	1,16
16	105,8	97,65	181360016	75	16	35	1,34
17	111,9	103,67	181360017	80	16	35	1,53
18	117,9	109,71	181360018	80	16	35	1,62
19	123,9	115,75	181360019	80	16	35	1,70

Z	de	dp	codice	dm	D1	A	Kg.
20	130,0	121,78	181360020	80	16	35	1,80
21	136,0	127,82	181360021	90	20	40	2,35
23	148,1	139,90	181360023	90	20	40	2,56
25	160,2	152,00	181360025	90	20	40	2,80

1" x 17,02 mm
25,4 x 17,02 mm
 Rullo 15,88 mm
16B - 1

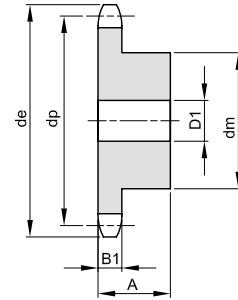
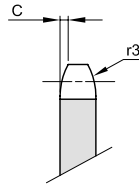

B1	C	r3
16,2	2,5	26

Materiale: INOX AISI 304 L

Z	de	dp	codice	dm	D1	A	Kg.
12	109,7	98,14	181380012	69	16	40	1,43
13	117,7	106,12	181380013	78	16	40	1,77
14	125,7	114,15	181380014	84	16	40	2,08
15	133,7	122,17	181380015	92	16	40	2,46
16	141,8	130,20	181380016	100	20	45	3,14
17	149,8	138,22	181380017	100	20	45	3,34
18	157,8	146,28	181380018	100	20	45	3,56

Z	de	dp	codice	dm	D1	A	Kg.
19	165,9	154,33	181380019	100	20	45	3,78
20	173,9	162,38	181380020	100	20	45	4,03
21	182,0	170,43	181380021	110	20	50	5,14



PIGNONI IN GHISA PER CATENE A RULLI - DIN 8187 - ISO 606

CAST IRON SPROCKETS FOR ROLLER CHAINS - DIN 8187 - ISO 606

3/8" x 7/32"
9,525 x 5,72 mm
 Rullo 6,35 mm
06B - 1 - 2 - 3

B1	B2	B3	b1	C	r3
5,3	15,4	25,6	5,2	1	10

Materiale: Ghisa EN-GJL-200

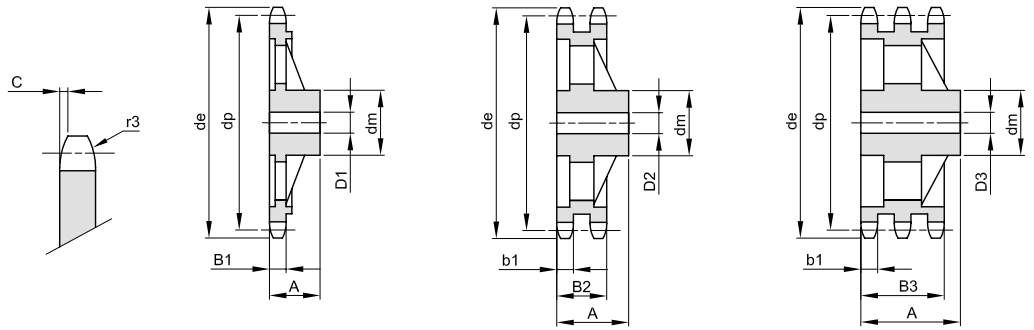

Z	de	dp	semplici				doppi				tripli							
			codice	dm	D1	A	Kg.	codice	dm	D2	A	Kg.	codice	dm	D3	A	Kg.	
38	119,0	115,34	151330038	70	20	32	1,12											
45	141,1	136,54	151330045	70	20	32	1,30	152330045	80	20	40	2,06	153330045	90	24	56	3,56	
57	177,5	172,91	151330057	70	20	32	1,55	152330057	80	20	40	2,30	153330057	90	24	56	3,97	
76	235,1	230,49	151330076	70	20	35	2,00	152330076	80	20	40	3,02	153330076	100	24	56	4,52	
95	292,7	288,08	151330095	80	20	40	3,83	152330095	90	20	45	4,68	153330095	100	24	56	6,12	
114	350,3	345,68	151330114	80	20	40	4,05	152330114	95	20	45	5,90	153330114	100	24	56	10,19	

1/2" x 5/16"
12,7 x 7,75 mm
 Rullo 8,51 mm
08B - 1 - 2 - 3

B1	B2	B3	b1	C	r3
7,2	21	34,9	7	1,3	13

Materiale: Ghisa EN-GJL-200

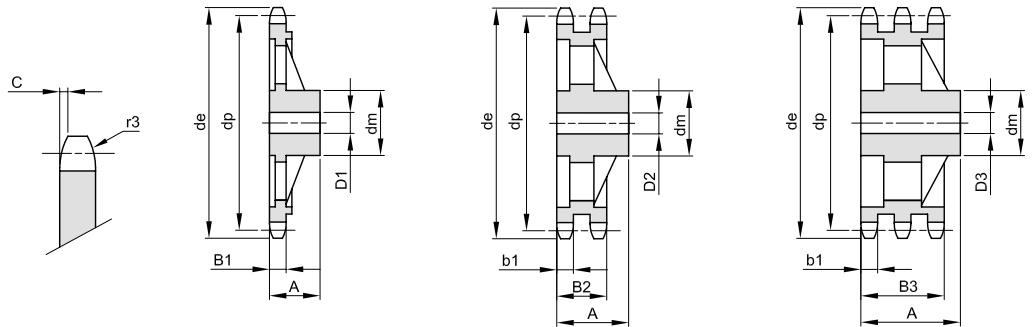

Z	de	dp	semplici				doppi				tripli							
			codice	dm	D1	A	Kg.	codice	dm	D2	A	Kg.	codice	dm	D3	A	Kg.	
38	158,6	153,80	151340038	70	24	40	1,56	152340038	90	24	50	3,15	153340038	100	24	60	4,45	
45	188,6	182,07	151340045	70	24	40	1,95	152340045	90	24	50	3,56	153340045	100	24	60	5,85	
57	237,1	230,54	151340057	70	24	40	2,46	152340057	90	24	50	4,00	153340057	100	24	60	6,28	
76	313,9	307,33	151340076	80	24	40	4,20	152340076	100	24	56	6,35	153340076	100	24	60	8,60	
95	390,7	384,11	151340095	80	24	45	5,45	152340095	100	24	56	8,00	153340095	120	24	67	11,90	
114	467,4	460,90	151340114	80	24	45	7,01	152340114	100	24	63	11,90						



PIGNONI IN GHISA PER CATENE A RULLI - DIN 8187 - ISO 606

CAST IRON SPROCKETS FOR ROLLER CHAINS - DIN 8187 - ISO 606

5/8" x 3/8"
15,875 x 9,65 mm
 Rullo 10,16 mm
10B - 1 - 2 - 3

B1	B2	B3	b1	C	r3
9,1	25,5	42,1	9	1,6	16

Materiale: Ghisa EN-GJL-200

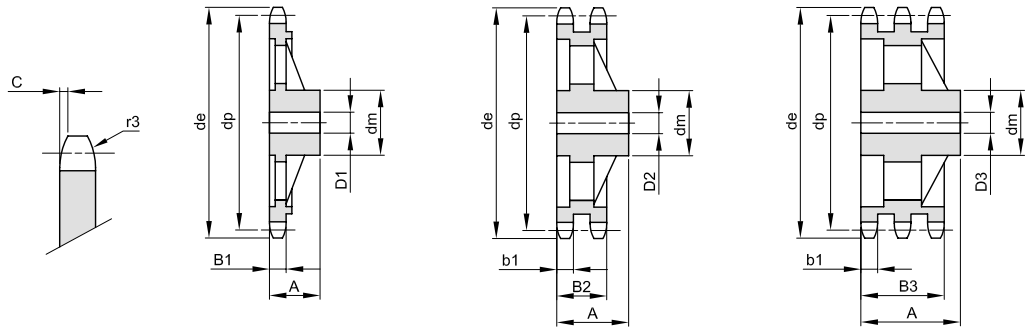

Z	de	dp	semplici				doppi				tripli						
			codice	dm	D1	A	Kg.	codice	dm	D2	A	Kg.	codice	dm	D3	A	Kg.
38	199,1	192,24	151350038	80	24	40	2,32	152350038	100	30	50	4,56	153350038	100	32	60	6,50
45	236,0	227,58	151350045	80	24	40	2,88	152350045	100	30	50	4,93	153350045	100	32	60	7,04
57	296,6	288,18	151350057	90	24	45	4,30	152350057	100	30	56	6,50	153350057	100	32	63	8,00
76	392,5	384,16	151350076	90	24	50	7,00	152350076	100	30	63	9,10	153350076	110	35	67	12,00
95	488,5	480,14	151350095	100	24	56	10,65	152350095	110	30	63	12,60	153350095	125	35	70	19,40
114	584,5	576,13	151350114	100	24	56	14,50	152350114	125	30	70	17,80	153350114	125	35	80	24,00

3/4" x 7/16"
19,05 x 11,68 mm
 Rullo 12,07 mm
12B - 1 - 2 - 3

B1	B2	B3	b1	C	r3
11,1	30,3	49,8	10,8	2	19

Materiale: Ghisa EN-GJL-200

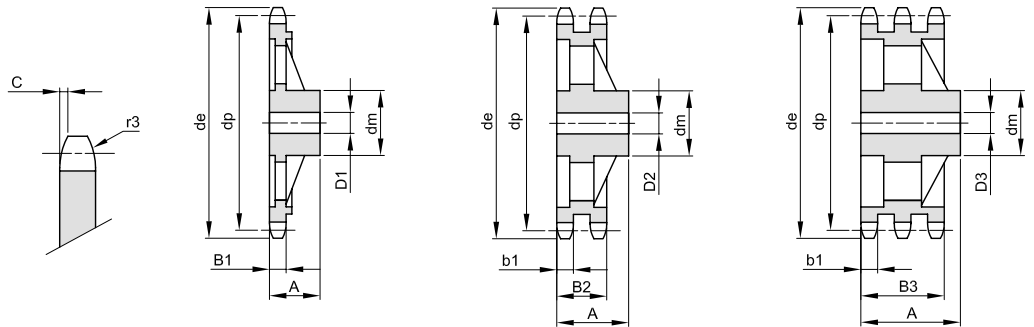

Z	de	dp	semplici				doppi				tripli						
			codice	dm	D1	A	Kg.	codice	dm	D2	A	Kg.	codice	dm	D3	A	Kg.
38	238,9	230,69	151360038	100	24	56	4,75	152360038	110	25	63	7,50	153360038	115	30	70	10,00
45	283,2	273,10	151360045	100	24	56	5,90	152360045	110	30	63	8,30	153360045	140	30	70	13,30
57	355,9	345,81	151360057	100	30	56	6,45	152360057	120	30	63	10,30	153360057	140	40	70	15,25
76	471,1	460,99	151360076	100	30	56	9,50	152360076	135	30	63	15,20	153360076	160	40	75	27,20
95	586,2	576,17	151360095	100	30	65	15,40	152360095	135	30	70	20,20	153360095	170	40	82	36,40
114	701,4	691,36	151360114	100	30	65	17,50	152360114	135	45	70	30,40	153360114	170	50	82	41,10



PIGNONI IN GHISA PER CATENE A RULLI - DIN 8187 - ISO 606

CAST IRON SPROCKETS FOR ROLLER CHAINS - DIN 8187 - ISO 606

1" x 17,02 mm
25,4 x 17,02 mm
Rullo 15,88 mm
16B - 1 - 2 - 3

B1 B2 B3 b1 C r3

16,2 47,7 79,6 15,8 2,5 26

Materiale: Ghisa EN-GJL-200

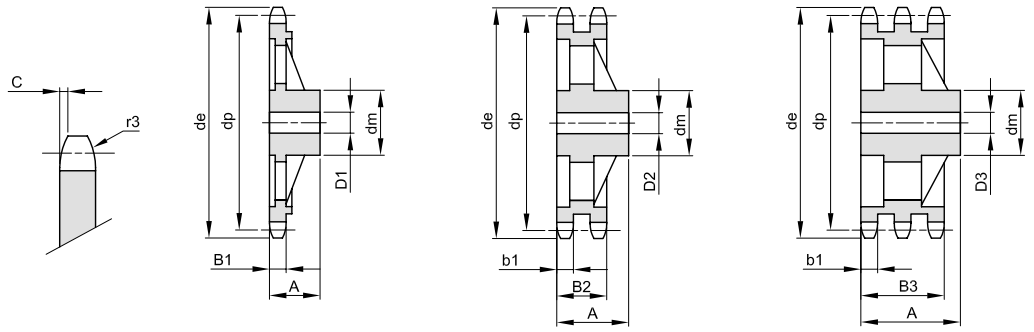

Z	de	dp	semplici					doppi					tripli				
			codice	dm	D1	A	Kg.	codice	dm	D2	A	Kg.	codice	dm	D3	A	Kg.
38	319,2	307,59	151380038	110	30	65	8,26	152380038	140	40	75	16,45	153380038	160	45	100	25,40
45	377,9	364,12	151380045	125	30	70	10,75	152380045	150	40	75	19,20	153380045	160	45	100	33,60
57	474,9	461,07	151380057	125	35	70	12,90	152380057	170	40	90	29,50	153380057	180	45	100	44,70
76	628,4	614,65	151380076	140	35	80	24,70	152380076	175	40	95	39,00	153380076	200	45	110	63,10
95	782,0	768,22	151380095	140	40	80	32,00	152380095	175	45	95	53,00	153380095	200	50	110	77,00
114	935,6	921,81	151380114	150	40	80	45,50	152380114	180	45	95	74,00	153380114	200	50	115	97,00

1"1/4 x 3/4"
31,75 x 19,56 mm
Rullo 19,05 mm
20B - 1 - 2 - 3

B1 B2 B3 b1 C r3

18,5 54,6 91 18,2 3,5 32

Materiale: Ghisa EN-GJL-200

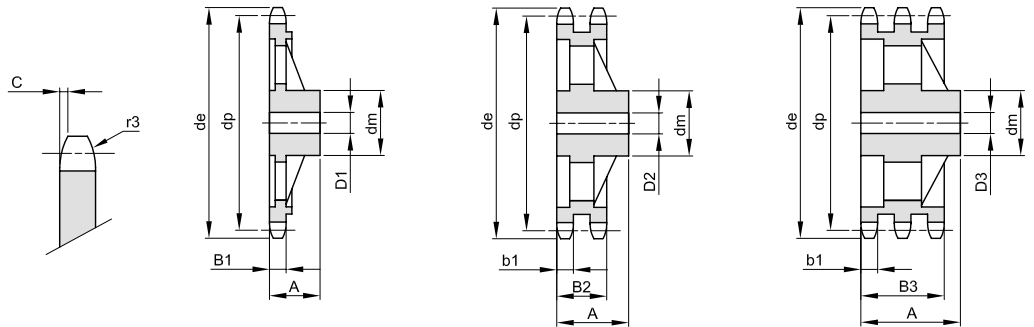

Z	de	dp	semplici					doppi					tripli				
			codice	dm	D1	A	Kg.	codice	dm	D2	A	Kg.	codice	dm	D3	A	Kg.
38	399,4	384,49	151400038	125	35	70	12,30	152400038	140	45	90	24,80	153400038	180	50	115	39,00
57	592,3	576,36	151400057	135	40	80	25,60	152400057	170	50	100	43,00	153400057	180	50	130	71,50
76	784,3	768,32	151400076	140	50	90	29,10	152400076	180	50	110	62,50	153400076	200	50	140	115,00



PIGNONI IN GHISA PER CATENE A RULLI - DIN 8187 - ISO 606
CAST IRON SPROCKETS FOR ROLLER CHAINS - DIN 8187 - ISO 606

1"1/2 x 1"
38,1 x 25,4 mm
Rullo 25,4 mm
24B - 1 - 2 - 3

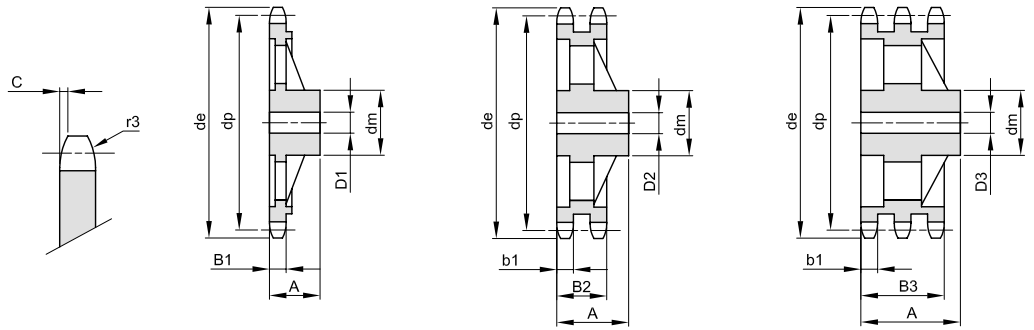

B1	B2	B3	b1	C	r3
24,1	72	120,3	23,6	4	38

Materiale: Ghisa EN-GJL-200

Z	de	dp	semplici					doppi				tripli					
			codice	dm	D1	A	Kg.	codice	dm	D2	A	Kg.	codice	dm	D3	A	Kg.
38	476,5	461,39	151420038	140	45	90	21,80	152420038	180	45	100	42,20	153420038	200	50	150	69,00
57	707,5	691,63	151420057	160	45	100	46,20	152420057	200	50	110	72,70	153420057	200	55	150	119,40
76	939,0	921,98	151420076	180	45	100	63,60	152420076	220	55	120	125,00					

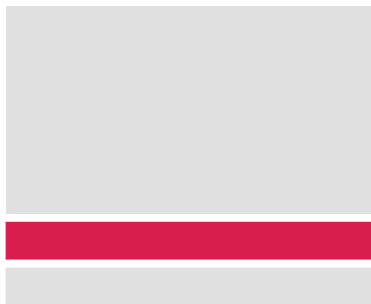



PIGNONI PER CATENE A RULLI - DIN 8188 - ISO 606 - ANSI B 29.1
SPROCKETS FOR ROLLER CHAINS - DIN 8188 - ISO 606 - ANSI B 29.1

ASA 25
6,35 x 3,18 mm
Rullo 3,3 mm
04C - 1

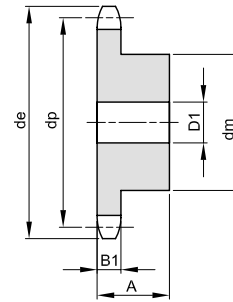
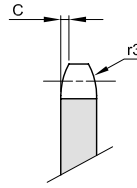

B1	B2	B3	b1	C	r3
2,9				0,6	6

Materiale: Acciaio C45

Z	de	dp	semplici					doppi				tripli						
			codice	dm	D1	A	Kg.	codice	dm	D2	A	Kg.	codice	dm	D3	A	Kg.	
8	18,1	16,59																
9	20,2	18,56																
10	22,3	20,55	131025010	12	6	15	0,02											
11	24,3	22,54	131025011	14	6	15	0,02											
12	26,4	24,53	131025012	16	6	15	0,03											
13	28,5	26,53	131025013	18	6	15	0,03											
14	30,5	28,53	131025014	20	6	15	0,04											
15	32,5	30,55	131025015	22	6	15	0,05											
16	34,5	32,55	131025016	24	8	15	0,06											
17	36,5	34,55	131025017	26	8	15	0,07											
18	38,5	36,56	131025018	28	8	15	0,08											
19	40,5	38,58	131025019	30	8	15	0,09											
20	42,5	40,58	131025020	32	8	15	0,10											
21	44,6	42,60	131025021	34	8	15	0,11											
22	46,6	44,62	131025022	36	8	15	0,12											
23	48,6	46,63	131025023	38	8	15	0,14											
24	50,6	48,64	131025024	40	8	18	0,18											
25	52,6	50,66	131025025	42	8	18	0,20											
26	54,6	52,67																
27	56,6	54,69	131025027	46	10	18	0,22											
28	58,7	56,71	131025028	48	10	18	0,25											
29	60,7	58,73																
30	62,7	60,75	131025030	48	10	18	0,27											
31	64,7	62,76																
32	66,7	64,78	131025032	50	12	18	0,29											
33	68,8	66,80																
34	70,8	68,82	131025034	50	12	18	0,28											
35	72,8	70,84	131025035	50	12	18	0,30											
36	74,8	72,85	131025036	50	12	18	0,31											
37	76,8	74,87																
38	78,8	76,89																
39	80,9	78,91																
40	82,9	80,93																



PIGNONI PER CATENE A RULLI - DIN 8188 - ISO 606 - ANSI B 29.1
SPROCKETS FOR ROLLER CHAINS - DIN 8188 - ISO 606 - ANSI B 29.1

ASA 35
9,525 x 4,77 mm
Rullo 5,08 mm
06C - 1 - 2

B1	B2	B3	b1	C	r3
4,3	14,3		4,1	1,2	10

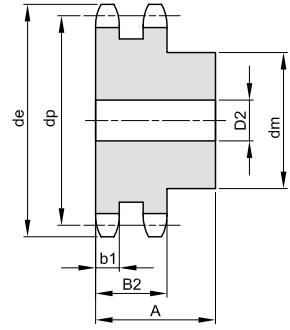
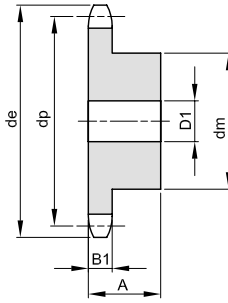
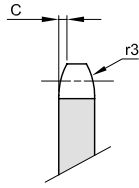

Materiale: Acciaio C45

Z	de	dp	semplici				doppi				tripli						
			codice	dm	D1	A	Kg.	codice	dm	D2	A	Kg.	codice	dm	D3	A	Kg.
8	28,6	24,89															
9	31,5	27,85	131035009	18	8	20	0,05										
10	34,5	30,82	131035010	20	8	20	0,05										
11	37,5	33,80	131035011	22	8	25	0,08										
12	40,5	36,80	131035012	25	8	25	0,10										
13	43,5	39,80	131035013	28	8	25	0,12	132035013	28	10	30	0,16					
14	46,5	42,80	131035014	31	8	25	0,15	132035014	31	10	30	0,19					
15	49,5	45,81	131035015	34	8	25	0,19	132035015	34	10	30	0,23					
16	52,5	48,82	131035016	37	10	28	0,24	132035016	37	12	30	0,27					
17	55,5	51,83	131035017	40	10	28	0,28	132035017	40	12	30	0,31					
18	58,6	54,85	131035018	43	10	28	0,32	132035018	43	12	30	0,36					
19	61,6	57,87	131035019	45	10	28	0,36	132035019	46	12	30	0,42					
20	64,6	60,89	131035020	46	10	28	0,38										
21	67,6	63,91	131035021	48	12	28	0,41	132035021	52	16	30	0,51					
22	70,6	66,93	131035022	50	12	28	0,45	132035022	55	16	30	0,57					
23	73,7	69,95	131035023	52	12	28	0,49	132035023	58	16	30	0,64					
24	76,7	72,97	131035024	54	12	28	0,54	132035024	61	16	30	0,71					
25	79,7	76,00	131035025	57	12	28	0,60	132035025	64	16	30	0,78					
26	82,7	79,02															
27	85,7	82,04	131035027	60	12	28	0,67	132035027	70	16	30	0,94					
28	88,8	85,07	131035028	60	12	28	0,68	132035028	73	16	30	1,02					
29	91,8	88,09	131035029	60	12	28	0,70										
30	94,8	91,12	131035030	60	12	30	0,72										
31	97,9	94,15															
32	100,9	97,17	131035032	65	14	30	0,86	132035032	80	16	30	1,31					
33	103,9	100,20															
34	106,9	103,23	131035034	65	14	30	0,92	132035034	80	16	30	1,42					
35	110,0	106,26	131035035	65	14	30	0,94	132035035	80	16	30	1,48					
36	113,0	109,29	131035036	70	16	30	1,05	132035036	90	16	30	1,69					
37	116,0	112,32	131035037	70	16	30	1,09										
38	119,0	115,34	131035038	70	16	30	1,08										
39	122,1	118,37															
40	125,1	121,40	131035040	70	16	30	1,10	132035040	90	16	30	1,90					



PIGNONI PER CATENE A RULLI - DIN 8188 - ISO 606 - ANSI B 29.1
SPROCKETS FOR ROLLER CHAINS - DIN 8188 - ISO 606 - ANSI B 29.1

ASA 40
12,7 x 7,95 mm
Rullo 7,95 mm
08A - 1 - 2

B1	B2	B3	b1	C	r3
7,2	21,4		7	1,6	13,5

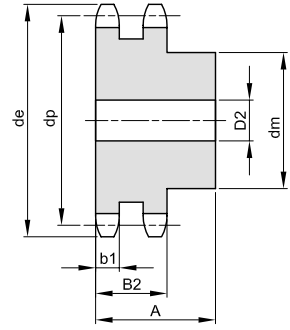
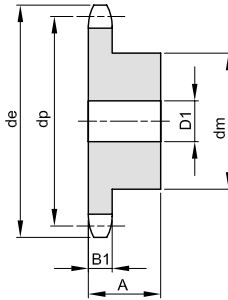
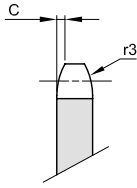

Materiale: Acciaio C45

Z	de	dp	semplici					doppi				tripli						
			codice	dm	D1	A	Kg.	codice	dm	D2	A	Kg.	codice	dm	D3	A	Kg.	
8	39,3	33,18																
9	43,2	37,13	131040009	24	10	25	0,09											
10	47,2	41,10	131040010	26	10	25	0,12	132040010	28	10	32	0,19						
11	51,2	45,07	131040011	29	10	25	0,14											
12	55,2	49,07	131040012	33	10	28	0,20	132040012	35	12	35	0,29						
13	59,2	53,06	131040013	37	10	28	0,26	132040013	38	12	35	0,35						
14	63,2	57,07	131040014	41	10	28	0,32	132040014	42	12	35	0,43						
15	67,2	61,09	131040015	45	10	28	0,38	132040015	46	12	35	0,52						
16	71,2	65,10	131040016	50	12	28	0,45	132040016	50	16	38	0,62						
17	75,2	69,11	131040017	52	12	28	0,50	132040017	54	16	38	0,73						
18	79,2	73,14	131040018	56	12	28	0,58											
19	83,3	77,16	131040019	60	12	28	0,67	132040019	62	16	38	0,97						
20	87,3	81,19	131040020	64	12	28	0,77											
21	91,3	85,22	131040021	68	14	28	0,84	132040021	70	16	40	1,28						
22	95,4	89,24	131040022	70	14	28	0,91	132040022	70	16	40	1,37						
23	99,4	93,27	131040023	70	14	28	0,94	132040023	70	16	40	1,46						
24	103,4	97,29	131040024	70	14	28	0,97	132040024	75	16	40	1,63						
25	107,4	101,33	131040025	70	14	28	1,01	132040025	80	16	40	1,82						
26	111,5	105,36	131040026	70	16	30	1,09	132040026	85	16	40	2,01						
27	115,5	109,40	131040027	70	16	30	1,13	132040027	85	16	40	2,12						
28	119,5	113,42	131040028	70	16	30	1,16	132040028	90	16	40	2,33						
29	123,6	117,46	131040029	80	16	30	1,41											
30	127,6	121,50	131040030	80	16	30	1,46	132040030	100	16	40	2,79						
31	131,6	125,54																
32	135,7	129,56	131040032	90	16	30	1,78											
33	139,7	133,60																
34	143,8	137,64	131040034	90	16	30	1,87											
35	147,8	141,68	131040035	90	16	30	1,92	132040035	100	16	40	3,40						
36	151,8	145,72	131040036	90	16	35	2,21											
37	155,9	149,76																
38	159,9	153,80	131040038	90	16	35	2,32											
39	163,9	157,83	131040039	90	16	35	2,37											
40	168,0	161,87	131040040	90	16	35	2,43											



PIGNONI PER CATENE A RULLI - DIN 8188 - ISO 606 - ANSI B 29.1
SPROCKETS FOR ROLLER CHAINS - DIN 8188 - ISO 606 - ANSI B 29.1

ASA 50
15,875 x 9,53 mm
Rullo 10,16 mm
10A - 1 - 2

B1	B2	B3	b1	C	r3
8,7	26,5		8,4	2	17

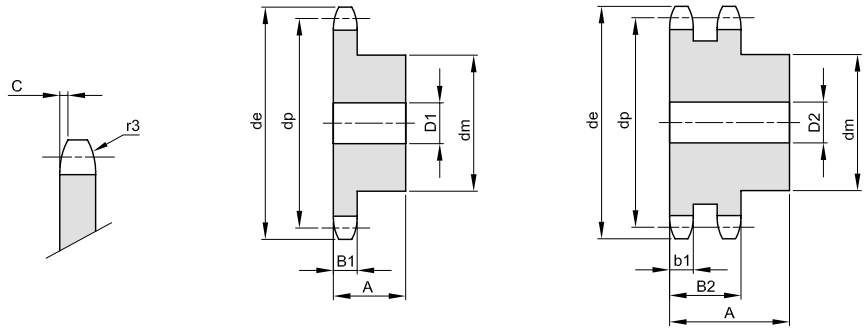

Materiale: Acciaio C45

Z	de	dp	semplici					doppi				tripli						
			codice	dm	D1	A	Kg.	codice	dm	D2	A	Kg.	codice	dm	D3	A	Kg.	
8	48,4	41,48	101350008	25	10	25	0,11											
9	53,3	46,42	101350009	30	10	25	0,16											
10	58,3	51,37	101350010	35	10	25	0,22	132050010	35	12	40	0,37						
11	63,2	56,34	101350011	37	12	30	0,29											
12	68,2	61,34	101350012	42	12	30	0,37	132050012	44	16	40	0,54						
13	73,2	66,32	101350013	47	12	30	0,46	132050013	49	16	40	0,67						
14	78,2	71,34	101350014	52	12	30	0,56	132050014	54	16	40	0,82						
15	83,2	76,36	101350015	57	12	30	0,67	132050015	59	16	40	0,97						
16	88,3	81,37	101350016	60	12	30	0,75	132050016	64	16	45	1,25						
17	93,3	86,39	101350017	60	12	30	0,87	132050017	69	16	45	1,45						
18	98,3	91,42	101350018	70	14	30	1,00											
19	103,3	96,45	101350019	70	14	30	1,15	132050019	79	16	45	1,67						
20	108,4	101,49	101350020	75	14	30	1,20	132050020	84	16	45	2,14						
21	113,4	106,52	101350021	75	16	30	1,35	132050021	85	16	45	2,27						
22	118,4	111,55	101350022	80	16	30	1,40	132050022	90	16	45	2,54						
23	123,5	116,58	101350023	80	16	30	1,47	132050023	95	16	45	2,81						
24	128,5	121,62	101350024	80	16	30	1,53	132050024	100	16	45	3,11						
25	133,6	126,66	101350025	80	16	30	1,60	132050025	105	16	45	3,14						
26	138,6	131,70	101350026	85	20	35	1,96	132050026	110	20	45	3,74						
27	143,6	136,75	101350027	85	20	35	2,03	132050027	110	20	45	3,94						
28	148,7	141,78	101350028	90	20	35	2,25	132050028	115	20	45	4,28						
29	153,7	146,83	101350029	90	20	35	2,33											
30	158,8	151,87	101350030	90	20	35	2,41											
31	163,8	156,92	101350031	95	20	35	2,64											
32	168,9	161,95	101350032	95	20	35	2,73											
33	173,9	167,00	101350033	95	20	35	2,82											
34	178,9	172,05	101350034	95	20	35	2,91											
35	184,0	177,10	101350035	95	20	35	3,01											
36	189,0	182,15	101350036	100	20	35	3,26											
37	194,1	187,20	101350037	100	20	35	3,36											
38	199,1	192,24	101350038	100	20	35	3,47											
39	204,2	197,29	101350039	100	20	35	3,57											
40	209,2	202,34	101350040	100	20	35	3,68											



PIGNONI PER CATENE A RULLI - DIN 8188 - ISO 606 - ANSI B 29.1
SPROCKETS FOR ROLLER CHAINS - DIN 8188 - ISO 606 - ANSI B 29.1

ASA 60
19,05 x 12,7 mm
Rullo 11,91 mm
12A - 1 - 2

B1	B2	B3	b1	C	r3
11,6	34,1		11,3	2,4	20

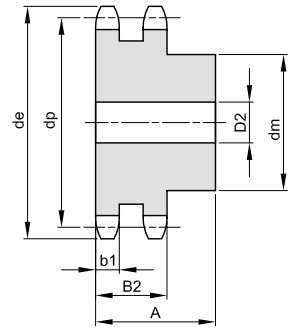
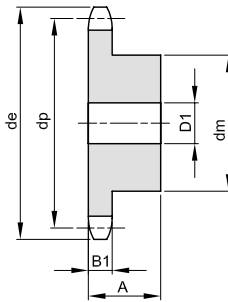
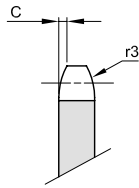

Materiale: Acciaio C45

Z	de	dp	semplici				doppi				tripli							
			codice	dm	D1	A	Kg.	codice	dm	D2	A	Kg.	codice	dm	D3	A	Kg.	
8	58,1	49,78																
9	64,0	55,70																
10	70,0	61,64	131060010	42	12	30	0,38	132060010	42	16	45	0,58						
11	76,0	67,61	131060011	46	16	35	0,50	132060011	47	16	50	0,80						
12	81,9	73,60	131060012	52	16	35	0,64	132060012	53	16	50	1,01						
13	87,9	79,59	131060013	58	16	35	0,80	132060013	59	16	50	1,24						
14	94,0	85,61	131060014	64	16	35	0,97	132060014	65	16	50	1,45						
15	100,0	91,63	131060015	70	16	35	1,16	132060015	71	16	50	1,73						
16	106,0	97,65	131060016	75	16	35	1,34	132060016	77	20	50	2,03						
17	112,0	103,67	131060017	80	16	35	1,53	132060017	83	20	50	2,35						
18	118,0	109,71	131060018	80	16	35	1,61	132060018	89	20	50	2,70						
19	124,1	115,75	131060019	80	16	35	1,70	132060019	95	20	50	3,06						
20	130,1	121,78	131060020	80	16	35	1,84	132060020	100	20	50	3,45						
21	136,2	127,82	131060021	90	20	40	2,35	132060021	100	20	50	3,69						
22	142,2	133,86	131060022	90	20	40	2,45	132060022	100	20	50	3,96						
23	148,2	139,90	131060023	90	20	40	2,56	132060023	110	20	50	4,50						
24	154,3	145,94	131060024	90	20	40	2,67	132060024	110	20	50	4,81						
25	160,3	152,00	131060025	90	20	40	2,79	132060025	120	20	50	5,40						
26	166,4	158,04	131060026	95	20	40	3,08	132060026	120	20	50	5,73						
27	172,4	164,09	131060027	95	20	40	3,21											
28	178,5	170,13	131060028	95	20	40	3,34	132060028	120	20	50	6,43						
29	184,5	176,19																
30	190,6	182,25	131060030	95	20	40	3,62	132060030	120	20	50	7,18						
31	196,6	188,31																
32	202,7	194,35	131060032	95	20	40	3,92											
33	208,8	200,40																
34	214,8	206,46	131060034	95	20	40	4,25											
35	220,9	212,52	131060035	95	20	40	4,41											
36	226,9	218,58	131060036	95	20	40	4,71											
37	233,0	224,64																
38	239,0	230,69	131060038	100	20	40	5,07											
39	245,1	236,75																
40	251,1	242,81	131060040	100	20	40	5,45											



PIGNONI PER CATENE A RULLI - DIN 8188 - ISO 606 - ANSI B 29.1
SPROCKETS FOR ROLLER CHAINS - DIN 8188 - ISO 606 - ANSI B 29.1

ASA 80
25,4 x 15,88 mm
Rullo 15,88 mm
16A - 1 - 2

B1	B2	B3	b1	C	r3
14,6	43,4		14,1	3,2	27

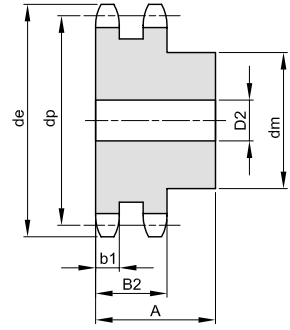
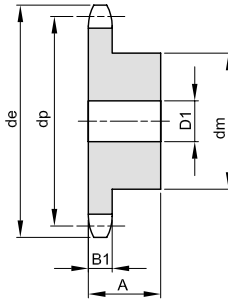
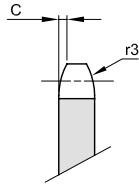

Materiale: Acciaio C45

Z	de	dp	semplici				doppi				tripli							
			codice	dm	D1	A	Kg.	codice	dm	D2	A	Kg.	codice	dm	D3	A	Kg.	
8	77,9	66,37	131080008	42	16	35	0,47											
9	85,8	74,27	131080009	50	16	35	0,65											
10	93,8	82,19	131080010	55	16	35	0,82											
11	101,7	90,14	131080011	61	16	40	1,13											
12	109,7	98,14	131080012	69	16	40	1,42											
13	117,7	106,12	131080013	78	16	40	1,77	132080013	80	20	70	3,22						
14	125,7	114,15	131080014	84	16	40	2,07	132080014	88	20	70	3,82						
15	133,7	122,17	131080015	92	16	40	2,46	132080015	96	20	70	4,51						
16	141,8	130,20	131080016	100	20	45	3,13	132080016	104	20	70	5,17						
17	149,8	138,22	131080017	100	20	45	3,34	132080017	112	20	70	5,97						
18	157,8	146,28	131080018	100	20	45	3,55	132080018	120	20	70	6,84						
19	165,9	154,33	131080019	100	20	45	3,78	132080019	128	20	70	7,75						
20	173,9	162,38	131080020	100	20	45	4,02	132080020	130	20	70	8,43						
21	182,0	170,43	131080021	110	20	50	5,01	132080021	130	20	70	9,10						
22	190,1	178,48	131080022	110	20	50	5,26											
23	198,1	186,53	131080023	110	20	50	5,56											
24	206,2	194,59	131080024	110	20	50	5,85											
25	214,2	202,66	131080025	110	20	50	6,16											
26	222,3	210,72	131080026	120	20	50	6,96											
27	230,4	218,79	131080027	120	20	50	7,29											
28	238,4	226,85	131080028	120	20	50	7,64											
29	246,5	234,92	131080029	120	20	50	7,78											
30	254,6	243,00	131080030	120	20	50	7,96											
31	262,6	251,08																
32	270,7	259,13																
33	278,8	267,21																
34	286,9	275,28	131080034	120	25	50	9,92											
35	294,9	283,36	131080035	120	25	50	10,36											
36	303,0	291,44																
37	311,1	299,51																
38	319,2	307,59	131080038	120	25	50	11,75											
39	327,2	315,67																
40	335,3	323,73																



PIGNONI PER CATENE A RULLI - DIN 8188 - ISO 606 - ANSI B 29.1
SPROCKETS FOR ROLLER CHAINS - DIN 8188 - ISO 606 - ANSI B 29.1

ASA 100
31,75 x 19,05 mm
Rullo 19,05 mm
20A - 1

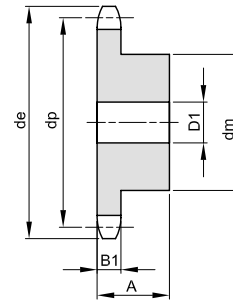
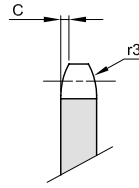

B1	B2	B3	b1	C	r3
17,6				4	33,5

Materiale: Acciaio C45

Z	de	dp	semplici					doppi				tripli					
			codice	dm	D1	A	Kg.	codice	dm	D2	A	Kg.	codice	dm	D3	A	Kg.
8	96,0	82,96	131100008	53	20	40	0,85										
9	106,5	92,84	131100009	63	20	40	1,18										
10	117,0	102,74	131100010	70	20	40	1,57										
11	127,0	112,68	131100011	77	20	45	2,04										
12	137,0	122,68	131100012	88	20	45	2,58										
13	147,5	132,65	131100013	98	20	45	3,15										
14	157,6	142,68	131100014	108	20	45	3,78										
15	167,7	152,72	131100015	118	20	45	4,47										
16	177,7	162,75	131100016	120	25	50	5,25										
17	187,7	172,78	131100017	120	25	50	5,61										
18	197,8	182,85	131100018	120	25	50	5,99										
19	207,9	192,91	131100019	120	25	50	6,40										
20	217,9	202,98	131100020	120	25	50	6,82										
21	228,0	213,04	131100021	140	25	55	8,79										
22	238,1	223,11	131100022	140	25	55	9,27										
23	248,2	233,17	131100023	140	25	55	9,77										
24	258,3	243,23	131100024	140	25	55	10,30										
25	268,4	253,33	131100025	140	25	55	10,85										
26	278,4	263,40															
27	288,5	273,48															
28	298,5	283,56															
29	308,6	293,65															
30	318,7	303,75															
31	328,8	313,85															
32	338,9	323,91															
33	349,0	334,01															
34	359,1	344,10															
35	369,2	354,20															
36	379,2	364,30															
37	389,3	374,39															
38	399,4	384,49															
39	409,5	394,59															
40	419,6	404,66															



PIGNONI PER CATENE A RULLI - DIN 8188 - ISO 606 - ANSI B 29.1
SPROCKETS FOR ROLLER CHAINS - DIN 8188 - ISO 606 - ANSI B 29.1

ASA 120
38,1 x 25,4 mm
Rullo 22,23 mm
24A - 1

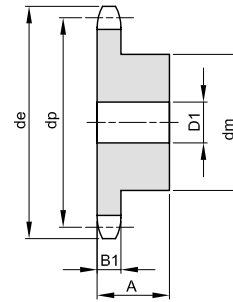
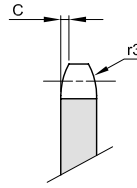

B1	B2	B3	b1	C	r3
23,5				4,8	40,5

Materiale: Acciaio C45 / *Materiale: Fe - con mozzo saldato

Z	de	dp	semplici				doppi				tripli							
			codice	dm	D1	A	Kg.	codice	dm	D2	A	Kg.	codice	dm	D3	A	Kg.	
8	113,0	99,55																
9	125,0	111,40																
10	137,0	123,29	131120010	80	20	45	2,67											
11	149,0	135,21	131120011	90	25	50	3,45											
12	161,0	147,22	131120012	102	25	50	4,26											
13	173,0	159,18	131120013	114	25	50	5,22											
14	185,0	171,22	131120014	128	25	50	6,29											
15	197,0	183,26	131120015	132	25	50	7,05											
16	209,0	195,30	131120016	136	25	55	8,41											
17	221,0	207,34	131120017	140	25	55	9,26											
18	233,0	219,42	131120018	140	25	55	9,95											
19	245,5	231,49																
20	257,5	243,57	131120020	140	25	55	11,56											
21	270,5	255,65																
22	282,5	267,73																
23	294,5	279,80																
24	307,0	291,88																
25	319,0	304,00	131120025	150	30	60	17,70											
26	331,0	316,08																
27	343,0	328,19																
28	355,0	340,27																
29	367,5	352,38																
30	379,5	364,50																
31	391,5	376,62																
32	403,5	388,69																
33	415,5	400,81																
34	428,0	412,93																
35	440,0	425,04	131120035	*150	30	60	30,01											
36	452,0	437,16																
37	464,0	449,27																
38	476,5	461,39																
39	488,5	473,50																
40	501,5	485,62																



PIGNONI PER CATENE A RULLI - DIN 8188 - ISO 606 - ANSI B 29.1
SPROCKETS FOR ROLLER CHAINS - DIN 8188 - ISO 606 - ANSI B 29.1

ASA 140
44,45 x 25,4 mm
Rullo 25,4 mm
28A - 1

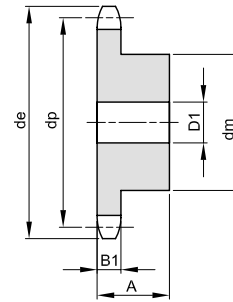
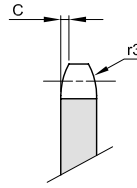

B1	B2	B3	b1	C	r3
23,5				5,8	47,5

Materiale: Acciaio C45

Z	de	dp	semplici				doppi				tripli							
			codice	dm	D1	A	Kg.	codice	dm	D2	A	Kg.	codice	dm	D3	A	Kg.	
8	132,0	116,15																
9	146,0	129,96																
10	160,0	143,85	131140010	100	25	70	5,23											
11	174,0	157,77	131140011	112	25	70	6,53											
12	188,0	171,74	131140012	125	25	70	8,02											
13	204,0	185,75	131140013	125	25	70	8,72											
14	218,0	199,76	131140014	125	25	70	9,46											
15	232,0	213,79																
16	246,0	227,84	131140016	160	30	75	14,65											
17	260,0	241,90	131140017	160	30	75	15,50											
18	274,0	255,98																
19	289,0	270,06																
20	303,0	284,15																
21	317,0	298,24																
22	331,0	312,34																
23	345,0	326,44																
24	359,0	340,55																
25	373,0	354,66																
26	387,0	368,77																
27	401,0	382,88																
28	416,0	397,00																
29	430,0	411,12																
30	444,0	425,24																
31	458,0	439,37																
32	472,0	453,49																
33	486,0	467,62																
34	500,0	481,75																
35	514,0	495,88																
36	529,0	510,01																
37	543,0	524,13																
38	557,0	538,27																
39	571,0	552,40																
40	585,0	566,54																

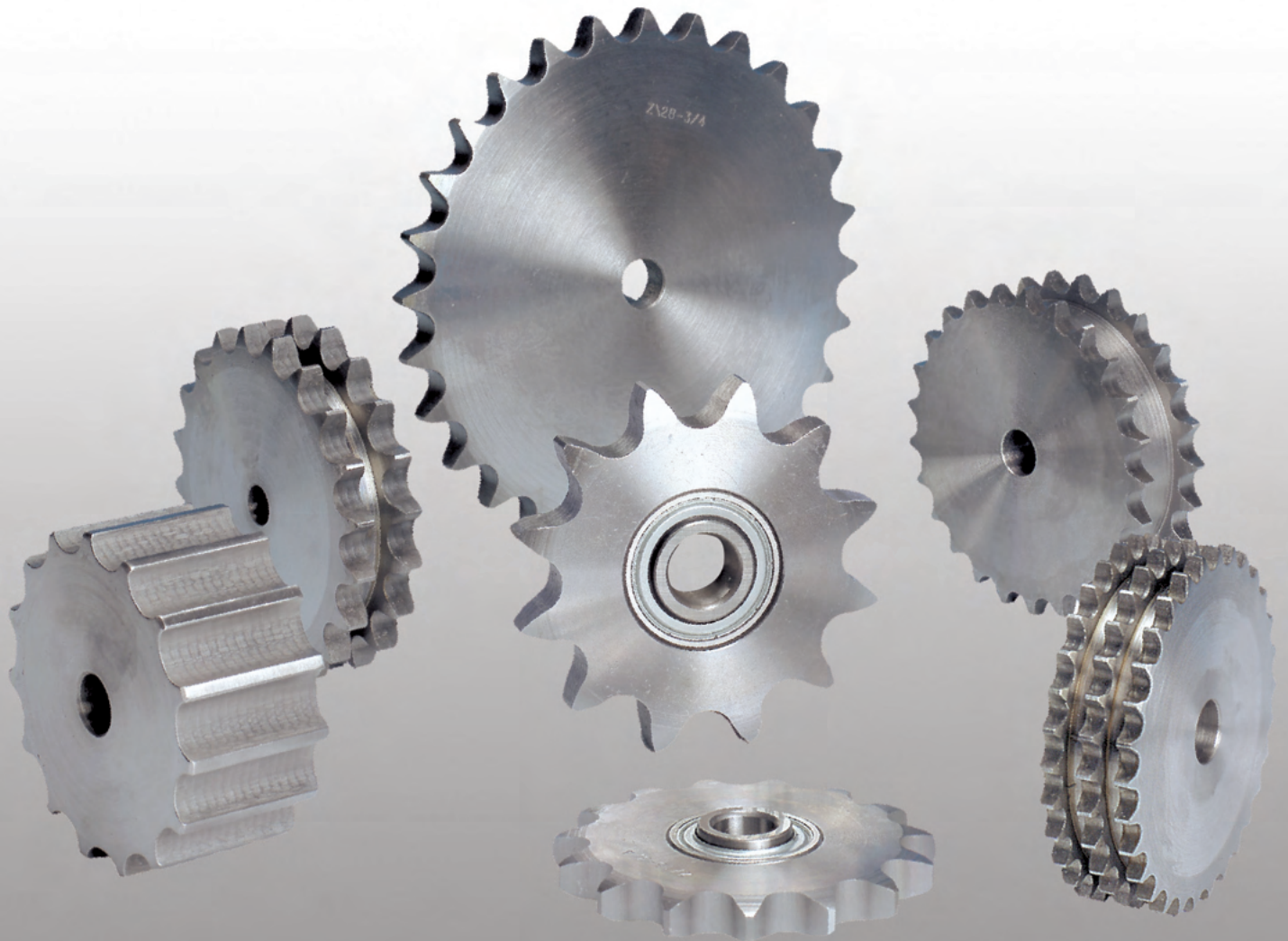



CORONE PER CATENE A RULLI - DIN 8187 - ISO 606

PLATE WHEELS FOR ROLLER CHAINS - DIN 8187 - ISO 606

6 x 2,8 mm

Rullo 4 mm

04 - 1

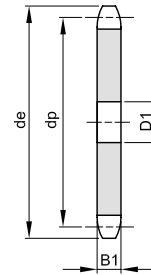
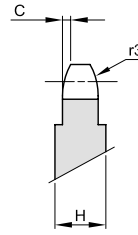
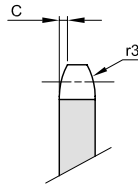

Da Z 51 H=4 mm

B1	B2	B3	b1	C	r3
2,6				0,6	6

Z	de	dp	semplici			doppi		
			codice	D1	Kg.	codice	D2	Kg.
8	18,0	15,67	201306008	5	0,01			
9	19,9	17,54	201306009	5	0,01			
10	21,7	19,42	201306010	6	0,01			
11	23,6	21,30	201306011	6	0,01			
12	25,4	23,18	201306012	6	0,01			
13	27,3	25,05	201306013	8	0,01			
14	29,2	26,96	201306014	8	0,01			
15	31,1	28,86	201306015	8	0,01			
16	33,0	30,76	201306016	8	0,01			
17	35,0	32,65	201306017	8	0,01			
18	36,9	34,55	201306018	8	0,02			
19	38,8	36,44	201306019	8	0,02			
20	40,7	38,44	201306020	8	0,02			
21	42,6	40,25	201306021	8	0,02			
22	44,5	42,16	201306022	8	0,02			
23	46,4	44,06	201306023	8	0,03			
24	48,3	45,96	201306024	8	0,03			
25	50,2	47,87	201306025	8	0,03			
26	52,1	49,77	201306026	8	0,03			
27	54,0	51,67	201306027	8	0,04			
28	55,9	53,58	201306028	8	0,04			
29	57,8	55,50						
30	59,8	57,42	201306030	8	0,05			
31	61,7	59,31						
32	63,6	61,21	201306032	10	0,05			
33	65,5	63,11	201306033	10	0,06			
34	67,4	65,02	201306034	10	0,06			
35	69,3	66,93	201306035	10	0,07			
36	71,2	68,84	201306036	10	0,07			
37	73,1	70,75	201306037	10	0,07			
38	75,0	72,66	201306038	10	0,08			
39	76,9	74,56						
40	78,9	76,47	201306040	10	0,09			
41	80,8	78,38						
42	82,7	80,28	201306042	12	0,10			
43	84,7	82,19						
44	86,6	84,10						
45	88,5	86,01	201306045	12	0,11			
46	90,4	87,92	201306046	12	0,12			
47	92,3	89,83						
48	94,2	91,74	201306048	12	0,13			
49	96,1	93,64						
50	98,0	95,55	201306050	12	0,14			
51	99,9	97,47						
52	101,8	99,37	201306052	12	0,25			
53	103,7	101,27						
54	105,6	103,17	201306054	12	0,26			
55	107,6	105,08	201306055	12	0,27			
56	109,5	107,00	201306056	12	0,28			
57	111,4	108,93	201306057	12	0,29			
58	113,3	110,82	201306058	12	0,30			
59	115,2	112,71						
60	117,5	114,62	201306060	12	0,33			
62	120,9	118,45	201306062	16	0,35			
64	124,7	122,27	201306064	16	0,37			
65	126,6	124,18	201306065	16	0,38			
66	128,5	126,09	201306066	16	0,40			
68	132,4	129,91						
70	136,2	133,73	201306070	16	0,45			
72	140,0	137,55						
75	145,7	143,28						
76	148,1	145,19	201306076	16	0,53			
78	151,5	149,01						
80	155,3	152,82	201306080	16	0,59			
85	164,8	162,37	201306085	16	0,67			
90	174,4	171,92	201306090	16	0,77			
95	183,9	181,47	201306095	16	0,85			
100	193,5	191,01	201306100	16	0,94			
110	211,6	210,11						
114	220,2	217,75	201306114	16	1,23			
120	231,7	229,20	201306120	16	1,37			
125	241,2	238,75	201306125	16	1,48			



CORONE PER CATENE A RULLI - DIN 8187 - ISO 606

PLATE WHEELS FOR ROLLER CHAINS - DIN 8187 - ISO 606

8 x 3,0 mm

Rullo 5 mm

05B - 1 - 2

B1	B2	B3	b1	C	r3
2,8	8,3		2,7	0,8	8

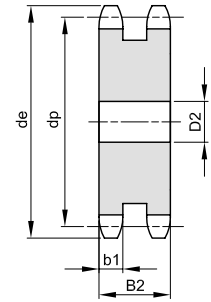
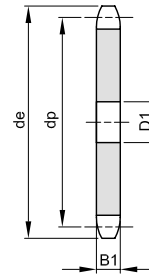
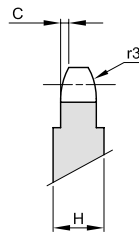
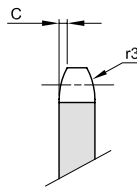

Da Z 46 H=4 mm

Z	de	dp	semplici			doppi			Z	de	dp	semplici			doppi		
			codice	D1	Kg.	codice	D2	Kg.				codice	D1	Kg.	codice	D2	Kg.
8	23,4	20,90	201308008	6	0,01	202308008	8	0,01	51	134,0	129,95						
9	25,9	23,39	201308009	6	0,01	202308009	8	0,01	52	136,6	132,49	201308052	16	0,43	202308052	16	0,82
10	28,4	25,89	201308010	8	0,01	202308010	8	0,02	53	139,1	135,04						
11	31,0	28,39	201308011	8	0,01	202308011	8	0,02	54	141,7	137,59	201308054	16	0,47			
12	33,7	30,91	201308012	8	0,01	202308012	8	0,03	55	144,2	140,13	201308055	16	0,49			
13	36,7	33,42	201308013	8	0,01	202308013	8	0,04	56	146,8	142,68				202308056	16	0,96
14	39,2	35,95	201308014	8	0,02	202308014	8	0,05	57	149,3	145,22	201308057	16	0,53	202308057	16	0,99
15	41,7	38,48	201308015	8	0,02	202308015	8	0,06	58	151,9	147,77	201308058	16	0,55			
16	44,2	41,01	201308016	8	0,02	202308016	10	0,07	59	154,5	150,31						
17	46,7	43,53	201308017	8	0,03	202308017	10	0,08	60	156,0	152,85	201308060	16	0,59	202308060	16	1,11
18	49,2	46,07	201308018	8	0,03	202308018	10	0,09	62	162,2	157,95	201308062	16	0,63			
19	51,7	48,61	201308019	8	0,03	202308019	10	0,10	64	167,3	163,04	201308064	16	0,67			
20	54,2	51,14	201308020	8	0,04				65	169,8	165,58	201308065	16	0,69	202308065	20	1,30
21	57,2	53,67	201308021	10	0,04	202308021	10	0,13	66	172,4	168,13						
22	59,4	56,21	201308022	10	0,05	202308022	10	0,14	68	177,5	173,22						
23	62,2	58,75	201308023	10	0,05	202308023	10	0,16	70	182,6	178,31	201308070	16	0,81			
24	64,7	61,29	201308024	10	0,06	202308024	10	0,17	72	187,7	183,41						
25	67,2	63,83	201308025	10	0,06	202308025	10	0,18	75	195,3	191,04	201308075	20	0,93			
26	69,7	66,37	201308026	10	0,07	202308026	12	0,18	76	196,7	193,59	201308076	20	0,94	202308076	20	1,80
27	72,3	68,91	201308027	10	0,07				78	203,0	198,68						
28	74,7	71,45	201308028	10	0,08	202308028	12	0,22	80	208,1	203,77	201308080	20	1,01	202308080	20	2,00
29	77,2	73,99	201308029	10	0,09				85	220,8	216,50	201308085	20	1,20			
30	80,2	76,53	201308030	10	0,09	202308030	12	0,25	90	233,6	229,23	201308090	20	1,35			
31	82,7	79,08	201308031	10	0,10				95	246,3	241,96	201308095	20	1,51			
32	85,2	81,61	201308032	10	0,11	202308032	12	0,29	100	259,1	254,68	201308100	20	1,68			
33	87,7	84,16	201308033	10	0,11				110	284,6	280,15						
34	90,2	86,70	201308034	10	0,12	202308034	12	0,34	114	294,8	290,33	201308114	20	2,20	202308114	20	4,15
35	92,7	89,24	201308035	10	0,13	202308035	12	0,36	120	310,1	305,61	201308120	20	2,44			
36	95,2	91,79	201308036	10	0,13	202308036	12	0,38	125	322,8	318,34	201308125	20	2,65			
37	97,7	94,33	201308037	12	0,14												
38	100,2	96,88	201308038	12	0,15	202308038	12	0,42									
39	102,7	99,42	201308039	12	0,16												
40	105,2	101,97	201308040	12	0,17	202308040	12	0,47									
41	108,4	104,51															
42	111,0	107,05	201308042	12	0,28												
43	113,5	109,60															
44	116,1	112,14	201308044	12	0,31												
45	118,6	114,69	201308045	12	0,32												
46	121,2	117,23	201308046	12	0,34	202308046	16	0,63									
47	123,7	119,77															
48	125,5	122,32	201308048	12	0,37	202308048	16	0,69									
49	128,9	124,86															
50	131,5	127,41	201308050	12	0,40	202308050	16	0,75									



CORONE PER CATENE A RULLI - DIN 8187 - ISO 606

PLATE WHEELS FOR ROLLER CHAINS - DIN 8187 - ISO 606

3/8" x 7/32"
9,525 x 5,72 mm
Rullo 6,35 mm
06B - 1 - 2 - 3

B1	B2	B3	b1	C	r3
5,3	15,4	25,6	5,2	1	10

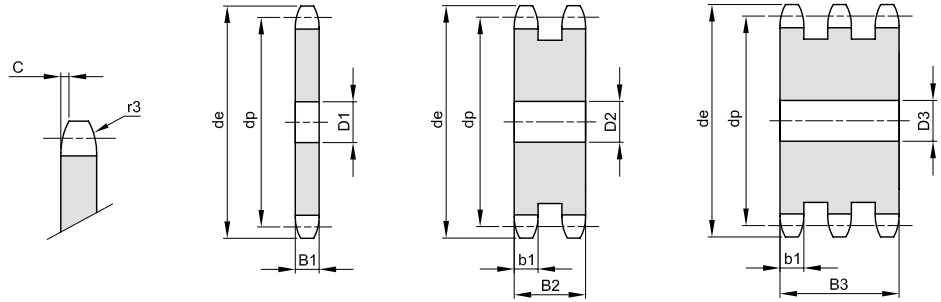

Z	de	dp	semplici			doppi			tripli		
			codice	D1	Kg.	codice	D2	Kg.	codice	D3	Kg.
8	28,6	24,89	201330008	6	0,01	202330008	8	0,03	203330008	8	0,04
9	31,5	27,85	201330009	8	0,02	202330009	8	0,04	203330009	8	0,06
10	34,5	30,82	201330010	8	0,02	202330010	8	0,05	203330010	10	0,08
11	37,5	33,80	201330011	8	0,03	202330011	10	0,06	203330011	12	0,09
12	40,5	36,80	201330012	8	0,03	202330012	10	0,08	203330012	12	0,12
13	43,5	39,80	201330013	8	0,04	202330013	10	0,10	203330013	12	0,15
14	46,5	42,80	201330014	8	0,05	202330014	10	0,12	203330014	12	0,18
15	49,5	45,81	201330015	8	0,06	202330015	10	0,14	203330015	12	0,22
16	52,5	48,82	201330016	10	0,06	202330016	12	0,16	203330016	12	0,26
17	55,5	51,83	201330017	10	0,07	202330017	12	0,19	203330017	12	0,30
18	58,6	54,85	201330018	10	0,08	202330018	12	0,21	203330018	12	0,35
19	61,6	57,87	201330019	10	0,09	202330019	12	0,24	203330019	12	0,39
20	64,6	60,89	201330020	10	0,10	202330020	12	0,27	203330020	12	0,44
21	67,6	63,91	201330021	10	0,12	202330021	12	0,30	203330021	16	0,48
22	70,6	66,93	201330022	10	0,13	202330022	12	0,34	203330022	16	0,54
23	73,7	69,95	201330023	10	0,14	202330023	12	0,37	203330023	16	0,59
24	76,7	72,97	201330024	10	0,15	202330024	12	0,41	203330024	16	0,66
25	79,7	76,00	201330025	10	0,17	202330025	12	0,45	203330025	16	0,72
26	82,7	79,02	201330026	10	0,18	202330026	16	0,48	203330026	16	0,79
27	85,7	82,04	201330027	10	0,20	202330027	16	0,53	203330027	16	0,86
28	88,8	85,07	201330028	10	0,21	202330028	16	0,57	203330028	16	0,93
29	91,8	88,09	201330029	10	0,23	202330029	16	0,62	203330029	16	1,01
30	94,8	91,12	201330030	10	0,25	202330030	16	0,66	203330030	16	1,09
31	97,9	94,15	201330031	12	0,26	202330031	16	0,71	203330031	16	1,17
32	100,9	97,17	201330032	12	0,28	202330032	16	0,77	203330032	16	1,26
33	103,9	100,20	201330033	12	0,30	202330033	16	0,82			
34	106,9	103,23	201330034	12	0,32	202330034	16	0,87	203330034	16	1,44
35	110,0	106,26	201330035	12	0,34	202330035	16	0,93	203330035	16	1,53
36	113,0	109,29	201330036	12	0,36	202330036	16	0,99	203330036	20	1,61
37	116,0	112,32	201330037	12	0,38	202330037	16	1,05			
38	119,0	115,34	201330038	12	0,40	202330038	16	1,11	203330038	20	1,81
39	122,1	118,37	201330039	12	0,43	202330039	16	1,18			
40	125,1	121,40	201330040	12	0,45	202330040	16	1,24	203330040	20	2,02
41	129,0	124,43	201330041	16	0,47	202330041	20	1,30			
42	132,1	127,46	201330042	16	0,49	202330042	20	1,36	203330042	20	2,25
43	135,1	130,49	201330043	16	0,52	202330043	20	1,44			
44	138,1	133,52	201330044	16	0,55	202330044	20	1,51	203330044	20	2,49
45	141,1	136,54	201330045	16	0,57	202330045	20	1,58	203330045	20	2,61
46	144,2	139,58	201330046	16	0,60	202330046	20	1,66			
47	147,2	142,61	201330047	16	0,63						
48	150,2	145,64	201330048	16	0,65	202330048	20	1,82	203330048	20	2,99
49	153,3	148,66	201330049	16	0,68	202330049	20	1,90			
50	156,3	151,69	201330050	20	0,71	202330050	20	1,98	203330050	20	3,27



CORONE PER CATENE A RULLI - DIN 8187 - ISO 606

PLATE WHEELS FOR ROLLER CHAINS - DIN 8187 - ISO 606

3/8" x 7/32"
9,525 x 5,72 mm
 Rullo 6,35 mm
06B - 1 - 2 - 3

B1	B2	B3	b1	C	r3
5,3	15,4	25,6	5,2	1	10

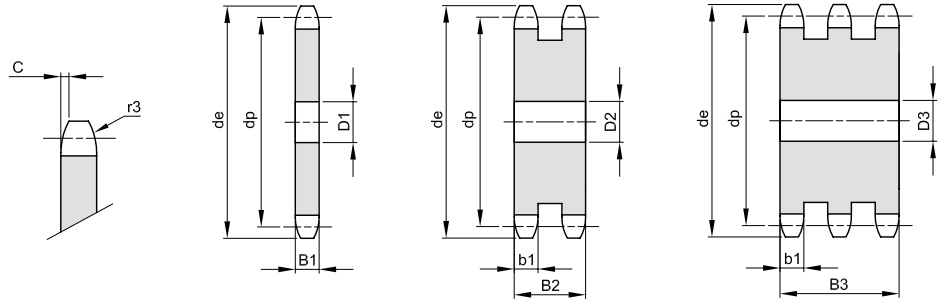

Z	de	dp	semplici			doppi			tripli		
			codice	D1	Kg.	codice	D2	Kg.	codice	D3	Kg.
51	159,3	154,72	201330051	20	0,74	202330051	20	2,06			
52	162,4	157,75	201330052	20	0,77	202330052	20	2,15			
53	165,4	160,78	201330053	20	0,80	202330053	20	2,22			
54	168,4	163,82	201330054	20	0,83	202330054	20	2,33			
55	171,4	166,85	201330055	20	0,86	202330055	20	2,42			
56	174,5	169,88	201330056	20	0,89	202330056	20	2,51			
57	177,5	172,91	201330057	20	0,93	202330057	20	2,61	203330057	25	4,28
58	180,5	175,93	201330058	20	0,96	202330058	20	2,71	203330058	25	4,44
60	186,6	181,99	201330060	20	1,03	202330060	20	2,91	203330060	25	4,77
62	192,7	188,06	201330062	20	1,10	202330062	25	3,09			
64	198,7	194,12	201330064	20	1,18	202330064	25	3,30	203330064	25	5,46
65	201,8	197,15	201330065	20	1,21	202330065	25	3,41	203330065	25	5,64
66	204,8	200,18	201330066	20	1,25				203330066	25	5,83
68	210,8	206,24	201330068	20	1,33	202330068	25	3,75			
70	216,9	212,30	201330070	20	1,41	202330070	25	3,99	203330070	25	6,59
72	223,0	218,37	201330072	20	1,50	202330072	25	4,23	203330072	25	6,99
75	232,1	227,46	201330075	20	1,63	202330075	25	4,60			
76	235,1	230,49	201330076	20	1,67	202330076	25	4,73	203330076	25	7,83
78	241,2	236,55				202330078	25	4,99			
80	247,2	242,61	201330080	20	1,86	202330080	25	5,26	203330080	25	8,71
85	262,4	257,77	201330085	25	2,10	202330085	25	5,96	203330085	25	9,87
90	277,5	272,93	201330090	25	2,36	202330090	25	6,71	203330090	25	11,11
95	292,7	288,08	201330095	25	2,63	202330095	25	7,50	203330095	25	12,42
100	307,8	303,25	201330100	25	2,92	202330100	25	8,34	203330100	25	13,81
110	338,2	333,55	201330110	25	3,54	202330110	25	10,14			
114	350,3	345,68	201330114	25	3,81	202330114	25	10,90	203330114	25	18,06
120	368,5	363,86	201330120	25	4,23	202330120	25	12,11			
125	383,6	379,02	201330125	25	4,59	202330125	25	13,16	203330125	25	21,81



CORONE PER CATENE A RULLI - DIN 8187 - ISO 606

PLATE WHEELS FOR ROLLER CHAINS - DIN 8187 - ISO 606

1/2" x 1/8"
12,7 x 3,3 mm
Rullo 7,75 mm
081 - 1

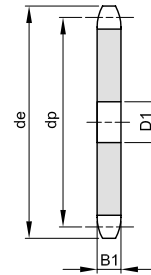
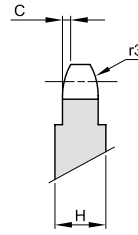
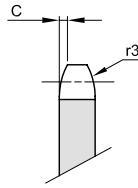

Da Z 31 H=4 mm
 Da Z 90 H=6 mm

B1	B2	B3	b1	C	r3
3				0,8	13

Z	de	dp	semplici			doppi			Z	de	dp	semplici			doppi		
			codice	D1	Kg.	codice	D2	Kg.				codice	D1	Kg.	codice	D2	Kg.
8	39,5	33,18							51	213,1	206,30						
9	43,4	37,13	201341009	8	0,02				52	217,1	210,34						
10	47,4	41,10	201341010	8	0,02				53	221,2	214,87						
11	51,4	45,07	201341011	8	0,03				54	225,2	218,43						
12	55,4	49,07	201341012	8	0,04				55	229,3	222,46	201341055	20	1,25			
13	59,4	53,06	201341013	8	0,04				56	233,3	226,50	201341056	20	1,30			
14	63,4	57,07	201341014	8	0,05				57	237,3	230,54	201341057	20	1,35			
15	67,4	61,09	201341015	8	0,06				58	241,4	234,58						
16	71,4	65,10	201341016	8	0,07				59	245,4	238,62						
17	75,4	69,11	201341017	8	0,08				60	249,5	242,66	201341060	20	1,50			
18	79,4	73,14	201341018	8	0,09				62	257,5	250,75						
19	83,5	77,16	201341019	8	0,10				64	265,6	258,82						
20	87,5	81,19	201341020	8	0,11				65	269,7	262,86						
21	91,5	85,22	201341021	8	0,11				66	273,7	266,90						
22	95,5	89,24	201341022	10	0,13				68	281,8	274,99						
23	99,6	93,27	201341023	10	0,15				70	289,9	283,07	201341070	25	2,05			
24	103,6	97,29	201341024	12	0,16				72	298,0	291,16						
25	107,6	101,33	201341025	12	0,17				75	310,1	303,27						
26	111,7	105,36	201341026	12	0,26				76	314,1	307,33						
27	115,7	109,40	201341027	12	0,28				78	322,2	315,40						
28	119,7	113,42	201341028	12	0,32				80	330,3	323,48						
29	123,8	117,46							85	350,5	343,69						
30	127,8	121,50	201341030	12	0,35				90	370,7	363,90						
31	131,8	125,54							95	390,9	384,11						
32	135,9	129,56	201341032	12	0,40				100	411,1	404,31						
33	139,9	133,60	201341033	12	0,43				110	451,5	444,74						
34	143,9	137,64	201341034	12	0,46				114	467,7	460,90						
35	148,0	141,68	201341035	12	0,49				120	492,0	485,16						
36	152,0	145,72	201341036	16	0,51				125	512,2	505,37						
37	156,1	149,76	201341037	16	0,55												
38	160,1	153,80	201341038	16	0,58												
39	164,1	157,83	201341039	16	0,61												
40	168,2	161,87	201341040	16	0,64												
41	172,7	165,91															
42	176,7	169,95															
43	180,8	173,99															
44	184,8	178,03	201341044	16	0,79												
45	188,9	182,07	201341045	16	0,82												
46	192,9	186,10															
47	196,9	190,14															
48	201,0	194,18	201341048	20	0,94												
49	205,0	198,22															
50	209,1	202,26															



CORONE PER CATENE A RULLI - DIN 8187 - ISO 606

PLATE WHEELS FOR ROLLER CHAINS - DIN 8187 - ISO 606

1/2" x 3/16"
12,7 x 4,88 mm
 Rullo 7,75 mm
083 - 1 / 084 - 1

B1	B2	B3	b1	C	r3
4,5				1,3	13

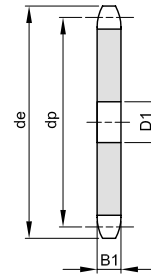
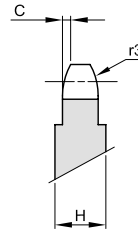
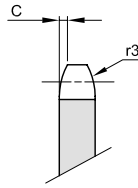

Da Z 90 H=6 mm

Z	de	dp	semplici			doppi			Z	de	dp	semplici			doppi		
			codice	D1	Kg.	codice	D2	Kg.				codice	D1	Kg.	codice	D2	Kg.
8	39,5	33,18	201342008	8	0,02				51	213,1	206,30	201342051	20	1,12			
9	43,4	37,13	201342009	8	0,03				52	217,1	210,34	201342052	20	1,17			
10	47,4	41,10	201342010	8	0,04				53	221,2	214,37	201342053	20	1,22			
11	51,4	45,07	201342011	8	0,05				54	225,2	218,43	201342054	20	1,26			
12	55,4	49,07	201342012	8	0,05				55	229,3	222,46	201342055	20	1,31			
13	59,4	53,06	201342013	8	0,06				56	233,3	226,50	201342056	20	1,36			
14	63,4	57,07	201342014	8	0,08				57	237,3	230,54	201342057	20	1,41			
15	67,4	61,09	201342015	8	0,09				58	241,4	234,58	201342058	20	1,46			
16	71,4	65,10	201342016	8	0,10				59	245,5	238,62						
17	75,4	69,11	201342017	8	0,12				60	249,5	242,66	201342060	20	1,57			
18	79,4	73,14	201342018	8	0,13				62	257,5	250,75						
19	83,5	77,16	201342019	8	0,15				64	265,6	258,82	201342064	20	1,80			
20	87,5	81,19	201342020	8	0,16				65	269,7	262,86	201342065	20	1,85			
21	91,5	85,22	201342021	8	0,18				66	273,7	266,90						
22	95,5	89,24	201342022	10	0,20				68	281,8	274,99	201342068	25	2,02			
23	99,6	93,27	201342023	10	0,22				70	289,9	283,07	201342070	25	2,14			
24	103,6	97,29	201342024	12	0,24				72	298,0	291,16	201342072	25	2,27			
25	107,6	101,33	201342025	12	0,26				75	310,1	303,27						
26	111,7	105,36	201342026	12	0,28				76	314,1	307,33	201342076	25	2,54			
27	115,7	109,40	201342027	12	0,30				78	322,2	315,40						
28	119,7	113,42	201342028	12	0,33				80	330,3	323,48	201342080	25	2,82			
29	123,8	117,46	201342029	12	0,35				85	350,5	343,69	201342085	25	3,19			
30	127,8	121,50	201342030	12	0,38				90	370,7	363,90						
31	131,8	125,54	201342031	12	0,40				95	390,9	384,11						
32	135,9	129,56	201342032	12	0,43				100	411,1	404,31	201342100	25	5,83			
33	139,9	133,60	201342033	12	0,46				110	451,5	444,74						
34	143,9	137,64	201342034	12	0,49				114	467,7	460,90						
35	148,0	141,68	201342035	12	0,52				120	492,0	485,16						
36	152,0	145,72	201342036	16	0,55				125	512,2	505,37						
37	156,1	149,76	201342037	16	0,58												
38	160,1	153,80	201342038	16	0,62												
39	164,1	157,83	201342039	16	0,65												
40	168,2	161,87	201342040	16	0,68												
41	172,7	165,91	201342041	16	0,72												
42	176,7	169,95	201342042	16	0,76												
43	180,8	173,99	201342043	16	0,80												
44	184,8	178,03	201342044	16	0,83												
45	188,9	182,07	201342045	16	0,87												
46	192,9	186,10	201342046	20	0,91												
47	196,9	190,14	201342047	20	0,95												
48	201,0	194,18	201342048	20	0,99												
49	205,0	198,22	201342049	20	1,04												
50	209,1	202,26	201342050	20	1,08												



CORONE PER CATENE A RULLI - DIN 8187 - ISO 606

PLATE WHEELS FOR ROLLER CHAINS - DIN 8187 - ISO 606

1/2" x 5/16"
12,7 x 7,75 mm
 Rullo 8,51 mm
08B - 1 - 2 - 3

B1	B2	B3	b1	C	r3
7,2	21	34,9	7	1,3	13

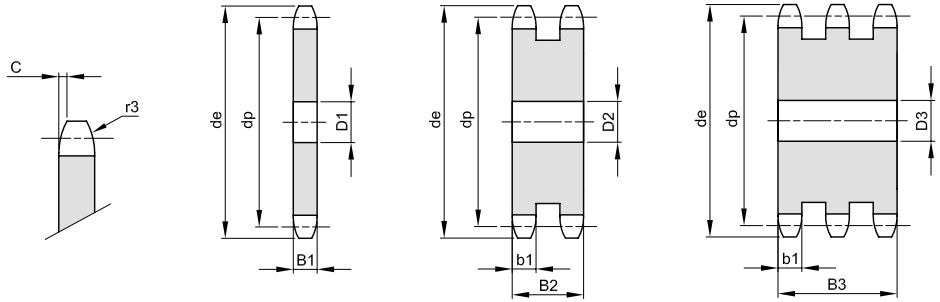

Z	de	dp	semplici			doppi			tripli		
			codice	D1	Kg.	codice	D2	Kg.	codice	D3	Kg.
8	38,0	33,18	201340008	8	0,03	202340008	10	0,07	203340008	10	0,11
9	42,0	37,13	201340009	8	0,04	202340009	10	0,10	203340009	10	0,16
10	45,9	41,10	201340010	8	0,06	202340010	10	0,13	203340010	10	0,21
11	49,9	45,07	201340011	10	0,07	202340011	10	0,17	203340011	12	0,26
12	53,9	49,07	201340012	10	0,08	202340012	10	0,21	203340012	12	0,33
13	57,9	53,06	201340013	10	0,10	202340013	10	0,25	203340013	12	0,40
14	61,9	57,07	201340014	10	0,12	202340014	10	0,30	203340014	12	0,48
15	65,9	61,09	201340015	10	0,14	202340015	10	0,36	203340015	12	0,57
16	69,9	65,10	201340016	10	0,16	202340016	12	0,41	203340016	16	0,64
17	74,0	69,11	201340017	10	0,18	202340017	12	0,47	203340017	16	0,74
18	78,0	73,14	201340018	10	0,20	202340018	12	0,54	203340018	16	0,85
19	82,0	77,16	201340019	10	0,23	202340019	12	0,61	203340019	16	0,97
20	86,0	81,19	201340020	10	0,26	202340020	12	0,68	203340020	16	1,09
21	90,1	85,22	201340021	12	0,28	202340021	16	0,75	203340021	16	1,22
22	94,1	89,24	201340022	12	0,31	202340022	16	0,83	203340022	16	1,36
23	98,1	93,27	201340023	12	0,34	202340023	16	0,92	203340023	16	1,50
24	102,1	97,29	201340024	12	0,38	202340024	16	1,01	203340024	16	1,63
25	106,2	101,33	201340025	12	0,41	202340025	16	1,10	203340025	16	1,81
26	110,2	105,36	201340026	16	0,44	202340026	16	1,20	203340026	16	1,98
27	114,2	109,40	201340027	16	0,48	202340027	16	1,31	203340027	16	2,15
28	118,3	113,42	201340028	16	0,52	202340028	16	1,42	203340028	16	2,33
29	122,3	117,46	201340029	16	0,56	202340029	16	1,53	203340029	16	2,52
30	126,3	121,50	201340030	16	0,60	202340030	16	1,65	203340030	16	2,71
31	130,4	125,54	201340031	16	0,64	202340031	16	1,77			
32	134,4	129,56	201340032	16	0,68	202340032	16	1,90	203340032	20	3,09
33	138,4	133,60	201340033	16	0,73	202340033	16	2,02	203340033	20	3,30
34	142,5	137,64	201340034	16	0,78	202340034	16	2,16	203340034	20	3,53
35	146,5	141,68	201340035	16	0,83	202340035	16	2,30	203340035	20	3,76
36	150,6	145,72	201340036	16	0,88	202340036	20	2,42	203340036	20	3,99
37	154,6	149,76	201340037	16	0,93	202340037	20	2,56			
38	158,6	153,80	201340038	16	0,98	202340038	20	2,71	203340038	20	4,49
39	162,7	157,83	201340039	16	1,03	202340039	20	2,87			
40	166,7	161,87	201340040	16	1,09	202340040	20	3,03	203340040	20	5,00
41	172,4	165,91	201340041	20	1,14	202340041	20	3,20			
42	176,5	169,95	201340042	20	1,20	202340042	20	3,36	203340042	25	5,51
43	180,5	173,99	201340043	20	1,26	202340043	20	3,53	203340043	25	5,80
44	184,6	178,03	201340044	20	1,32	202340044	20	3,71	203340044	25	6,09
45	188,6	182,07	201340045	20	1,38	202340045	20	3,89	203340045	25	6,39
46	192,6	186,10	201340046	20	1,45	202340046	20	4,07	203340046	25	6,70
47	196,7	190,14	201340047	20	1,51				203340047	25	7,00
48	200,7	194,18	201340048	20	1,58	202340048	20	4,96	203340048	25	7,33
49	204,8	198,22	201340049	20	1,65	202340049	20	4,66			
50	208,8	202,26	201340050	20	1,72	202340050	20	4,86	203340050	25	8,00



CORONE PER CATENE A RULLI - DIN 8187 - ISO 606

PLATE WHEELS FOR ROLLER CHAINS - DIN 8187 - ISO 606

1/2" x 5/16"
12,7 x 7,75 mm
Rullo 8,51 mm
08B - 1 - 2 - 3

B1	B2	B3	b1	C	r3
7,2	21	34,9	7	1,3	13

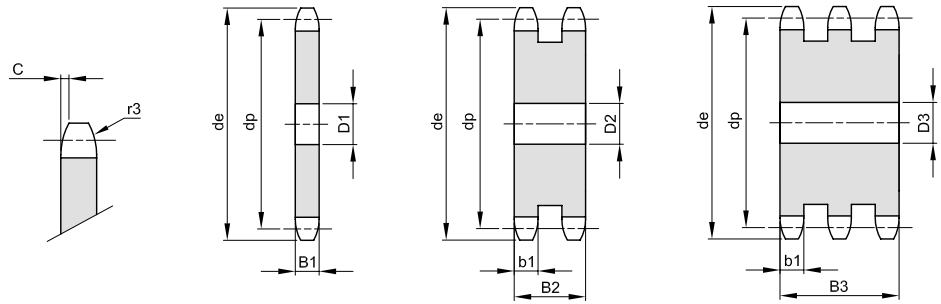

Z	de	dp	semplici			doppi			tripli		
			codice	D1	Kg.	codice	D2	Kg.	codice	D3	Kg.
51	212,8	206,30	201340051	20	1,80	202340051	25	5,03			
52	216,9	210,34	201340052	20	1,87	202340052	25	5,24	203340052	25	8,68
53	220,9	214,37	201340053	20	1,94	202340053	25	5,46			
54	225,0	218,43	201340054	20	2,02	202340054	25	5,68	203340054	25	9,40
55	229,0	222,46	201340055	20	2,10	202340055	25	5,90	203340055	25	9,77
56	233,0	226,50	201340056	20	2,17	202340056	25	6,13	203340056	25	10,15
57	237,1	230,54	201340057	20	2,25	202340057	25	6,36	203340057	25	10,53
58	241,1	234,58	201340058	20	2,34	202340058	25	6,59			
59	245,2	238,62									
60	249,2	242,66	201340060	20	2,50	202340060	25	7,08	203340060	25	11,73
62	257,3	250,75	201340062	25	2,67	202340062	25	7,60	203340062	25	15,56
64	265,4	258,82	201340064	25	2,70	202340064	25	8,10			
65	269,4	262,86	201340065	25	2,78	202340065	25	8,36	203340065	25	13,86
66	273,4	266,90	201340066	25	2,94						
68	281,5	274,99	201340068	25	3,00	202340068	25	9,20	203340068	25	15,22
70	289,6	283,07	201340070	25	3,22	202340070	25	9,75	203340070	25	16,17
72	297,7	291,16	201340072	25	3,50	202340072	25	10,33	203340072	25	17,14
75	309,8	303,27	201340075	25	3,80	202340075	25	11,24	203340075	25	18,65
76	313,9	307,33	201340076	25	3,90	202340076	25	11,55	203340076	25	19,17
78	321,9	315,40	201340078	25	3,90						
80	330,0	323,48	201340080	25	4,26	202340080	25	12,90	203340080	25	21,82
85	350,2	343,69	201340085	25	4,76	202340085	25	14,55	203340085	25	24,15
90	370,4	363,90	201340090	25	5,52	202340090	25	16,36	203340090	25	27,17
95	390,7	384,11	201340095	25	6,12	202340095	25	18,28	203340095	25	30,36
100	410,9	404,31	201340100	25	6,70	202340100	25	20,30	203340100	25	33,73
110	451,3	444,74	201340110	25	7,88	202340110	25	24,67			
114	467,4	460,90	201340114	25	8,31	202340114	25	26,53	203340114	25	44,10
120	491,7	485,16	201340120	25	9,60	202340120	25	29,46			
125	511,0	505,37	201340125	25	10,00	202340125	25	32,00	203340125	25	55,21



CORONE PER CATENE A RULLI - DIN 8187 - ISO 606

PLATE WHEELS FOR ROLLER CHAINS - DIN 8187 - ISO 606

5/8" x 3/8"
15,875 x 9,65 mm
 Rullo 10,16 mm
10B - 1 - 2 - 3

B1	B2	B3	b1	C	r3
9,1	25,5	42,1	9	1,6	16

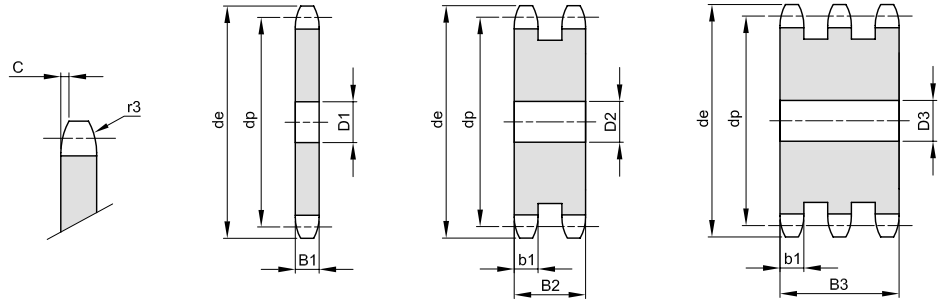

Z	de	dp	semplici			doppi			tripli		
			codice	D1	Kg.	codice	D2	Kg.	codice	D3	Kg.
8	48,4	41,48	201350008	10	0,06	202350008	10	0,15	203350008	12	0,23
9	53,3	46,42	201350009	10	0,09	202350009	10	0,21	203350009	12	0,32
10	58,3	51,37	201350010	10	0,11	202350010	10	0,27	203350010	12	0,44
11	63,2	56,34	201350011	10	0,14	202350011	10	0,34	203350011	12	0,55
12	68,2	61,34	201350012	10	0,17	202350012	10	0,42	203350012	12	0,67
13	73,2	66,32	201350013	10	0,20	202350013	10	0,51	203350013	12	0,81
14	78,2	71,34	201350014	12	0,23	202350014	10	0,60	203350014	12	0,97
15	83,2	76,36	201350015	12	0,27	202350015	12	0,70	203350015	12	1,14
16	88,3	81,37	201350016	12	0,31	202350016	12	0,82	203350016	16	1,29
17	93,3	86,39	201350017	12	0,36	202350017	12	0,94	203350017	16	1,49
18	98,3	91,42	201350018	12	0,41	202350018	12	1,06	203350018	16	1,70
19	103,3	96,45	201350019	12	0,46	202350019	12	1,20	203350019	16	1,92
20	108,4	101,49	201350020	12	0,51	202350020	12	1,34	203350020	16	2,15
21	113,4	106,52	201350021	12	0,57	202350021	16	1,48	203350021	16	2,40
22	118,4	111,55	201350022	12	0,62	202350022	16	1,64	203350022	16	2,66
23	123,5	116,58	201350023	12	0,69	202350023	16	1,80	203350023	16	2,94
24	128,5	121,62	201350024	12	0,75	202350024	16	1,98	203350024	16	3,23
25	133,6	126,66	201350025	12	0,82	202350025	16	2,17	203350025	16	3,53
26	138,6	131,70	201350026	16	0,88	202350026	20	2,33	203350026	20	3,81
27	143,6	136,75	201350027	16	0,95	202350027	20	2,53	203350027	20	4,13
28	148,7	141,78	201350028	16	1,03	202350028	20	2,74	203350028	20	4,47
29	153,7	146,83	201350029	16	1,11	202350029	20	2,96	203350029	20	4,83
30	158,8	151,87	201350030	16	1,19	202350030	20	3,18	203350030	20	5,20
31	163,8	156,92	201350031	16	1,28	202350031	20	3,41			
32	168,9	161,95	201350032	16	1,36	202350032	20	3,66	203350032	20	5,97
33	173,9	167,00	201350033	16	1,45	202350033	20	3,90	203350033	20	6,38
34	178,9	172,05	201350034	16	1,55	202350034	20	4,16	203350034	20	6,80
35	184,0	177,10	201350035	16	1,64	202350035	20	4,42	203350035	20	7,23
36	189,0	182,15	201350036	20	1,73	202350036	20	4,70	203350036	25	7,62
37	194,1	187,20	201350037	20	1,83	202350037	20	4,98	203350037	25	8,08
38	199,1	192,24	201350038	20	1,94	202350038	20	5,26	203350038	25	8,55
39	204,2	197,29	201350039	20	2,05	202350039	20	5,56	203350039	25	9,04
40	209,2	202,34	201350040	20	2,16	202350040	20	5,87	203350040	25	9,54
41	215,8	207,39	201350041	20	2,29				203350041	25	10,05
42	220,8	212,44	201350042	20	2,39	202350042	25	6,46	203350042	25	10,58
43	225,9	217,49	201350043	20	2,50	202350043	25	6,80			
44	230,9	222,53	201350044	20	2,63	202350044	25	7,13	203350044	25	11,67
45	236,0	227,58	201350045	20	2,75	202350045	25	7,47	203350045	25	12,24
46	241,0	236,63	201350046	20	2,88	202350046	25	7,83	203350046	25	12,82
47	246,1	237,68	201350047	20	3,01	202350047	25	8,19			
48	251,1	242,73	201350048	20	3,14	202350048	25	8,55	203350048	25	14,01
49	256,2	247,78	201350049	20	3,28						
50	261,2	252,82	201350050	20	3,42	202350050	25	9,32	203350050	25	15,26



CORONE PER CATENE A RULLI - DIN 8187 - ISO 606

PLATE WHEELS FOR ROLLER CHAINS - DIN 8187 - ISO 606

5/8" x 3/8"
15,875 x 9,65 mm
 Rullo 10,16 mm
10B - 1 - 2 - 3

B1	B2	B3	b1	C	r3
9,1	25,5	42,1	9	1,6	16

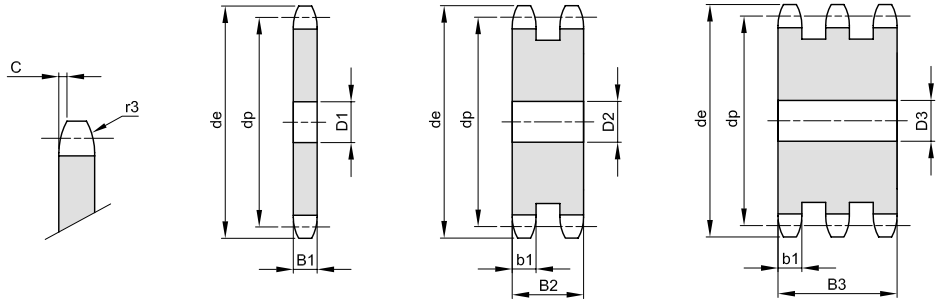

Z	de	dp	semplici			doppi			tripli		
			codice	D1	Kg.	codice	D2	Kg.	codice	D3	Kg.
51	266,3	257,87	201350051	20	3,56						
52	271,3	262,92	201350052	20	3,70	202350052	25	10,11	203350052	25	16,57
53	276,4	267,97	201350053	20	3,85	202350053	25	10,52			
54	281,4	273,03	201350054	20	4,00	202350054	25	10,94			
55	286,5	278,08	201350055	20	4,15	202350055	25	11,36	203350055	25	18,62
56	291,5	283,13	201350056	25	4,30	202350056	25	11,80			
57	296,6	288,18	201350057	25	4,46	202350057	25	12,24	203350057	25	20,06
58	301,6	293,23	201350058	25	4,62	202350058	25	12,68			
60	311,7	303,32	201350060	25	4,95	202350060	25	13,61	203350060	25	22,31
62	321,8	313,43	201350062	25	5,30	202350062	25	14,56			
64	331,9	323,53	201350064	25	5,65				203350064	30	25,43
65	337,0	328,58	201350065	25	5,83	202350065	25	16,05	203350065	30	26,26
66	342,0	333,63				202350066	25	16,57			
68	352,1	343,74	201350068	25	6,40						
70	362,2	353,84	201350070	25	6,79	202350070	25	18,70	203350070	30	30,61
72	372,3	363,95	201350072	25	6,80	202350072	25	19,81			
75	387,5	379,09	201350075	25	7,81	202350075	25	21,54	203350075	30	30,35
76	392,5	384,16	201350076	25	8,02	202350076	25	22,14	203350076	30	36,27
78	402,6	394,25	201350078	25	8,46						
80	412,7	404,35	201350080	25	8,91	202350080	25	24,60	203350080	30	40,30
85	438,0	429,62	201350085	30	10,06	202350085	30	28,00			
90	463,3	454,88	201350090	30	11,30	202350090	30	31,25	203350090	30	51,32
95	488,5	480,14	201350095	30	12,61	202350095	30	34,90	203350095	30	57,32
100	513,8	505,40	201350100	30	13,99	202350100	30	38,75			
110	564,3	555,92	201350110	30	15,50						
114	584,5	576,13	201350114	30	17,50	202350114	30	50,60	203350114	30	83,15
120	614,8	606,44	201350120	30	17,60	202350120	30	56,16			
125	640,1	631,71	201350125	30	21,00	202350125	30	61,00	203350125	30	100,29



CORONE PER CATENE A RULLI - DIN 8187 - ISO 606

PLATE WHEELS FOR ROLLER CHAINS - DIN 8187 - ISO 606

3/4" x 7/16"
19,05 x 11,68 mm
 Rullo 12,07 mm
12B - 1 - 2 - 3

B1	B2	B3	b1	C	r3
11,1	30,3	49,8	10,8	2	19

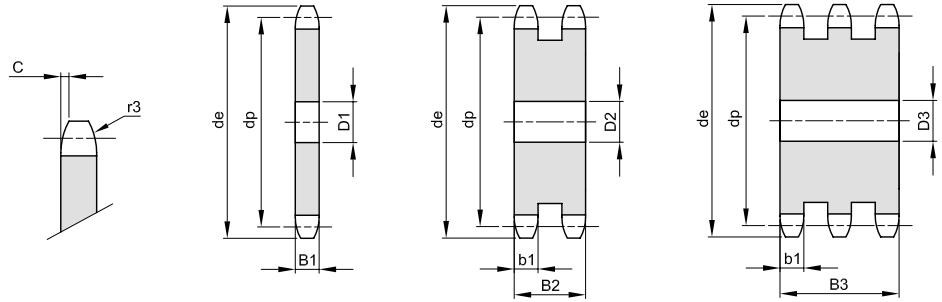

Z	de	dp	semplici			doppi			tripli		
			codice	D1	Kg.	codice	D2	Kg.	codice	D3	Kg.
8	58,0	49,78	201360008	10	0,12	202360008	12	0,26	203360008	12	0,31
9	63,9	55,70	201360009	10	0,15	202360009	12	0,36	203360009	12	0,57
10	69,8	61,64	201360010	10	0,20	202360010	12	0,46	203360010	12	0,74
11	75,8	67,61	201360011	12	0,24	202360011	12	0,59	203360011	16	0,91
12	81,8	73,50	201360012	14	0,30	202360012	14	0,72	203360012	16	1,13
13	87,8	79,59	201360013	14	0,35	202360013	14	0,88	203360013	16	1,38
14	93,8	85,61	201360014	14	0,41	202360014	16	1,02	203360014	16	1,64
15	99,8	91,63	201360015	14	0,48	202360015	16	1,20	203360015	16	1,93
16	105,8	97,65	201360016	14	0,55	202360016	16	1,39	203360016	20	2,20
17	111,9	103,67	201360017	14	0,63	202360017	16	1,60	203360017	20	2,54
18	117,9	109,71	201360018	14	0,71	202360018	16	1,81	203360018	20	2,89
19	123,9	115,75	201360019	14	0,80	202360019	16	2,05	203360019	20	3,27
20	130,0	121,78	201360020	14	0,89	202360020	16	2,30	203360020	20	3,67
21	136,0	127,82	201360021	16	0,99	202360021	20	2,53	203360021	20	4,10
22	142,0	133,86	201360022	16	1,03	202360022	20	2,80	203360022	20	4,55
23	148,1	139,90	201360023	16	1,20	202360023	20	3,09	203360023	20	5,02
24	154,1	145,94	201360024	16	1,31	202360024	20	3,39	203360024	20	5,51
25	160,2	152,00	201360025	16	1,43	202360025	20	3,70	203360025	20	6,02
26	166,2	158,04	201360026	16	1,56	202360026	20	4,03	203360026	20	6,56
27	172,3	164,09	201360027	16	1,68	202360027	20	4,38	203360027	20	7,12
28	178,3	170,13	201360028	16	1,82	202360028	20	4,73	203360028	20	7,71
29	184,4	176,19	201360029	16	1,96	202360029	20	5,10	203360029	20	8,31
30	190,4	182,25	201360030	16	2,10	202360030	20	5,49	203360030	20	8,97
31	196,5	188,31	201360031	20	2,24	202360031	20	5,88	203360031	25	9,52
32	202,5	194,35	201360032	20	2,39	202360032	20	6,30	203360032	25	10,19
33	208,6	200,40	201360033	20	2,55	202360033	20	6,72	203360033	25	10,89
34	214,6	206,46	201360034	20	2,71	202360034	20	7,16	203360034	25	11,61
35	220,7	212,52	201360035	20	2,88	202360035	20	7,61	203360035	25	12,35
36	226,8	218,58	201360036	20	3,06	202360036	25	7,99	203360036	25	13,11
37	232,8	224,64	201360037	20	3,24	202360037	25	8,47	203360037	25	13,90
38	238,9	230,69	201360038	20	3,42	202360038	25	8,96	203360038	25	14,70
39	244,9	236,75	201360039	20	3,61	202360039	25	9,50	203360039	25	15,54
40	251,0	242,81	201360040	20	3,80	202360040	25	9,99	203360040	25	16,40
41	258,9	248,87	201360041	25	3,98	202360041	25	10,51			
42	265,0	254,93	201360042	25	4,19	202360042	25	11,07	203360042	25	18,17
43	271,1	260,98	201360043	25	4,38	202360043	25	11,63	203360043	25	19,09
44	277,1	267,03	201360044	25	4,61	202360044	25	12,21	203360044	25	20,03
45	283,2	273,10	201360045	25	4,83	202360045	25	12,80	203360045	25	21,00
46	289,2	279,16	201360046	25	5,05	202360046	25	13,40			
47	295,3	285,21	201360047	25	5,28	202360047	25	14,02	203360047	25	23,00
48	301,4	291,27	201360048	25	5,52	202360048	25	14,65	203360048	25	24,04
49	307,4	297,33	201360049	25	5,76						
50	313,5	303,39	201360050	25	6,00	202360050	25	15,95	203360050	25	26,17



CORONE PER CATENE A RULLI - DIN 8187 - ISO 606

PLATE WHEELS FOR ROLLER CHAINS - DIN 8187 - ISO 606

3/4" x 7/16"
19,05 x 11,68 mm
 Rullo 12,07 mm
12B - 1 - 2 - 3

B1	B2	B3	b1	C	r3
11,1	30,3	49,8	10,8	2	19

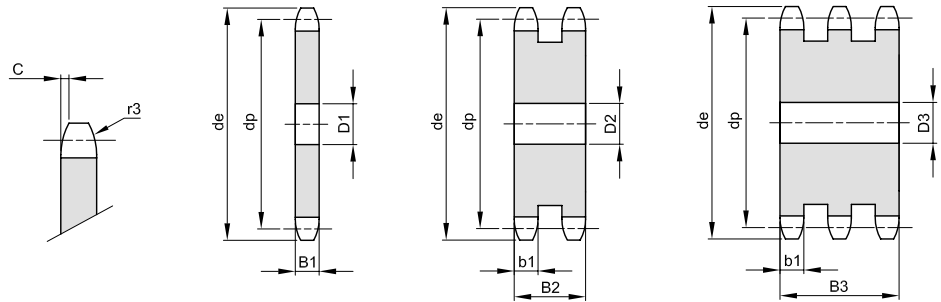

Z	de	dp	semplici			doppi			tripli		
			codice	D1	Kg.	codice	D2	Kg.	codice	D3	Kg.
51	319,5	309,45	201360051	25	6,25						
52	325,6	315,50	201360052	25	6,50	202360052	25	17,31	203360052	25	28,40
53	331,6	321,56	201360053	25	6,77						
54	337,7	327,64	201360054	25	7,03	202360054	25	18,73	203360054	25	30,72
55	343,8	333,70	201360055	25	7,30	202360055	25	19,45	203360055	25	31,91
56	349,8	339,75	201360056	25	7,57	202360056	25	20,20			
57	355,9	345,81	201360057	25	7,85	202360057	25	20,95	203360057	30	34,28
58	362,0	351,87	201360058	25	8,13	202360058	25	21,72			
60	374,1	363,99	201360060	25	8,72	202360060	25	23,30	203360060	30	38,12
62	386,2	376,12	201360062	25	9,33						
64	398,3	388,24	201360064	25	9,95	202360064	30	26,62			
65	404,4	394,29	201360065	25	10,27	202360065	30	27,48	203360065	30	45,00
68	422,6	412,49	201360068	30	11,24	202360068	30	29,00			
70	434,7	424,61	201360070	30	11,92	202360070	30	32,01	203360070	30	52,42
72	446,8	436,74	201360072	30	12,63	202360072	30	33,92	203360072	30	55,55
75	465,0	454,91	201360075	30	13,72	202360075	30	36,88			
76	471,1	460,99	201360076	30	14,09	202360076	30	37,90	203360076	30	62,09
78	483,2	473,10	201360078	30	14,86						
80	495,3	485,22	201360080	30	15,65	202360080	30	42,10	203360080	30	68,98
85	525,6	515,55	201360085	30	17,70	202360085	30	47,66	203360085	30	78,10
90	555,9	545,86	201360090	30	19,87	202360090	30	53,36	203360090	30	87,79
95	586,2	576,17	201360095	30	20,10	202360095	30	59,80	203360095	30	98,04
100	616,6	606,47	201360100	30	24,60	202360100	30	66,39	203360100	30	108,86
110	677,2	667,11	201360110	30	29,84						
114	701,4	691,36	201360114	30	32,07	202360114	30	86,68	203360114	30	142,15
120	737,8	727,74	201360120	30	35,58				203360120	30	157,77
125	768,1	758,05	201360125	30	38,63	202360125	30	104,50	203360125	30	171,41



CORONE PER CATENE A RULLI - DIN 8187 - ISO 606

PLATE WHEELS FOR ROLLER CHAINS - DIN 8187 - ISO 606

1" x 17,02 mm
25,4 x 17,02 mm
Rullo 15,88 mm
16B - 1 - 2 - 3

B1	B2	B3	b1	C	r3
16,2	47,7	79,6	15,8	2,5	26

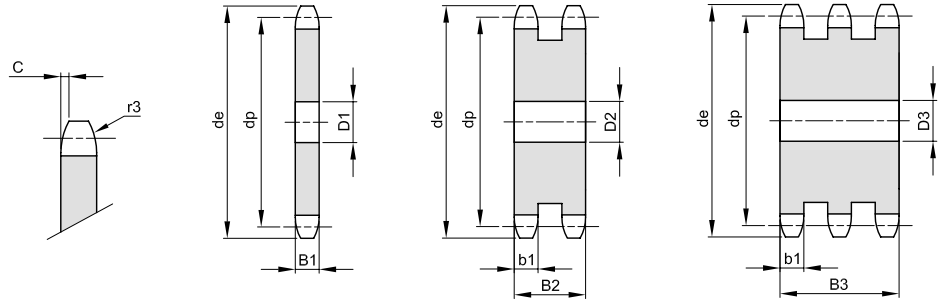

Z	de	dp	semplici			doppi			tripli		
			codice	D1	Kg.	codice	D2	Kg.	codice	D3	Kg.
8	77,9	66,37	201380008	16	0,30	202380008	16	0,71	203380008	16	1,13
9	85,8	74,27	201380009	16	0,39	202380009	16	0,97	203380009	16	1,56
10	93,8	82,19	201380010	16	0,51	202380010	16	1,27	203380010	16	2,05
11	101,7	90,14	201380011	16	0,63	202380011	20	1,57	203380011	20	2,53
12	109,7	98,14	201380012	16	0,77	202380012	20	1,94	203380012	20	3,15
13	117,7	106,12	201380013	16	0,92	202380013	20	2,36	203380013	20	3,84
14	125,7	114,15	201380014	16	1,08	202380014	20	2,81	203380014	20	4,59
15	133,7	122,17	201380015	16	1,26	202380015	20	3,31	203380015	20	5,40
16	141,8	130,20	201380016	20	1,43	202380016	20	3,84	203380016	25	6,16
17	149,8	138,22	201380017	20	1,50	202380017	20	4,41	203380017	25	7,11
18	157,8	146,28	201380018	20	1,85	202380018	20	5,01	203380018	25	8,11
19	165,9	154,33	201380019	20	2,08	202380019	20	5,66	203380019	25	9,18
20	173,9	162,38	201380020	20	2,32	202380020	20	6,34	203380020	25	10,31
21	182,0	170,43	201380021	20	2,58	202380021	25	7,00	203380021	25	11,51
22	190,1	178,48	201380022	20	2,84	202380022	25	7,76	203380022	25	12,77
23	198,1	186,53	201380023	20	3,13	202380023	25	8,56	203380023	25	14,10
24	206,2	194,59	201380024	20	3,42	202380024	25	9,40	203380024	25	14,49
25	214,2	202,66	201380025	20	3,73	202380025	25	10,28	203380025	25	16,94
26	222,3	210,72	201380026	20	4,05	202380026	25	11,20	203380026	30	18,33
27	230,4	218,79	201380027	20	4,38	202380027	25	12,15	203380027	30	19,91
28	238,4	226,85	201380028	20	4,73	202380028	25	13,14	203380028	30	21,55
29	246,5	234,92	201380029	20	5,09	202380029	25	14,17	203380029	30	23,26
30	254,6	243,00	201380030	20	5,46	202380030	25	15,24	203380030	30	25,04
31	262,6	251,08	201380031	25	5,82	202380031	25	16,35	203380031	30	26,88
32	270,7	259,13	201380032	25	6,22	202380032	25	17,50	203380032	30	28,78
33	278,8	267,21	201380033	25	6,63	202380033	25	18,68	203380033	30	30,75
34	286,9	275,28	201380034	25	7,06	202380034	25	19,90	203380034	30	32,78
35	294,9	283,36	201380035	25	7,50	202380035	25	21,16	203380035	30	34,88
36	303,0	291,44	201380036	25	7,95	202380036	25	22,46	203380036	30	37,04
37	311,1	299,51	201380037	25	8,41	202380037	25	23,80			
38	319,2	307,59	201380038	25	8,88	202380038	25	25,18	203380038	30	41,56
39	327,2	315,67	201380039	25	9,37	202380039	25	26,59			
40	335,3	323,73	201380040	25	9,88	202380040	25	28,04	203380040	30	46,42
41	345,6	331,82	201380041	25	10,39						
42	353,7	339,90	201380042	25	10,92	202380042	25	31,07	203380042	30	51,34
43	361,7	347,98	201380043	25	11,46						
44	369,8	356,06	201380044	25	12,02	202380044	25	34,24	203380044	30	56,63
45	377,9	364,12	201380045	25	12,60	202380045	25	35,89	203380045	30	59,36
46	386,0	372,21	201380046	25	13,17	202380046	25	37,56	203380046	30	62,17
47	394,1	380,29	201380047	25	13,76						
48	402,1	388,36	201380048	25	14,37	202380048	25	41,06	203380048	30	67,97
49	410,2	396,44	201380049	25	14,99						
50	418,3	404,52	201380050	25	15,63	202380050	25	44,70	203380050	30	74,01



CORONE PER CATENE A RULLI - DIN 8187 - ISO 606

PLATE WHEELS FOR ROLLER CHAINS - DIN 8187 - ISO 606

1" x 17,02 mm
25,4 x 17,02 mm
Rullo 15,88 mm
16B - 1 - 2 - 3

B1	B2	B3	b1	C	r3
16,2	47,7	79,6	15,8	2,5	26

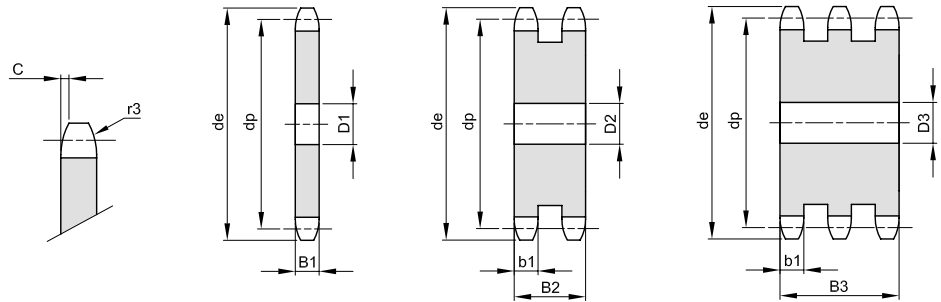

Z	de	dp	semplici			doppi			tripli		
			codice	D1	Kg.	codice	D2	Kg.	codice	D3	Kg.
51	426,4	412,60	201380051	30	16,25						
52	434,5	420,67	201380052	30	16,90	202380052	30	48,40	203380052	40	79,98
53	442,5	428,75	201380053	30	17,58						
54	450,6	436,85	201380054	30	18,26						
55	458,7	444,93	201380055	30	18,96	202380055	30	54,38	203380055	40	89,92
56	466,8	453,01	201380056	30	19,67	202380056	40	56,24			
57	474,9	461,07	201380057	30	20,50	202380057	40	58,35	203380057	40	96,87
58	482,9	469,16	201380058	30	21,13						
60	499,1	485,32	201380060	30	22,65	202380060	40	64,90	203380060	40	107,78
62	515,3	501,50	201380062	30	24,22	202380062	40	69,46			
64	531,4	517,65	201380064	30	25,84						
65	539,5	525,73	201380065	30	26,67	202380065	40	76,59	203380065	40	127,24
68	563,8	549,98	201380068	30	29,23	202380068	40	84,07			
70	579,9	566,14	201380070	30	31,01	202380070	40	89,24	203380070	40	148,31
72	596,1	582,32	201380072	30	32,84	202380072	40	94,60	203380072	40	157,18
75	620,3	606,55	201380075	30	35,68	202380075	40	102,85			
76	628,4	614,65	201380076	30	36,65	202380076	40	105,69	203380076	40	175,70
78	644,6	630,80	201380078	30	38,64						
80	660,7	646,96	201380080	30	40,68	202380080	40	117,43	203380080	40	195,25
85	701,2	687,40	201380085	30	46,00	202380085	40	132,96	203380085	40	221,13
90	741,6	727,81	201380090	30	51,65	202380090	40	149,46	203380090	40	248,61
95	782,0	768,22	201380095	30	57,62	202380095	40	166,91	203380095	40	277,70
100	822,4	808,63	201380100	30	63,62	202380100	40	181,33			
110	903,3	889,48	201380110	30	77,50						
114	935,6	921,82	201380114	30	83,31	202380114	40	242,01	203380114	40	402,85
120	984,1	970,33	201380120	30	92,40						
125	1024,5	1010,73	201380125	30	100,33	202380125	40	291,84	203380125	40	485,90



CORONE PER CATENE A RULLI - DIN 8187 - ISO 606

PLATE WHEELS FOR ROLLER CHAINS - DIN 8187 - ISO 606

1"1/4 x 3/4"
31,75 x 19,56 mm
 Rullo 19,05 mm
20B - 1 - 2 - 3

B1	B2	B3	b1	C	r3
18,5	54,6	91	18,2	3,5	32

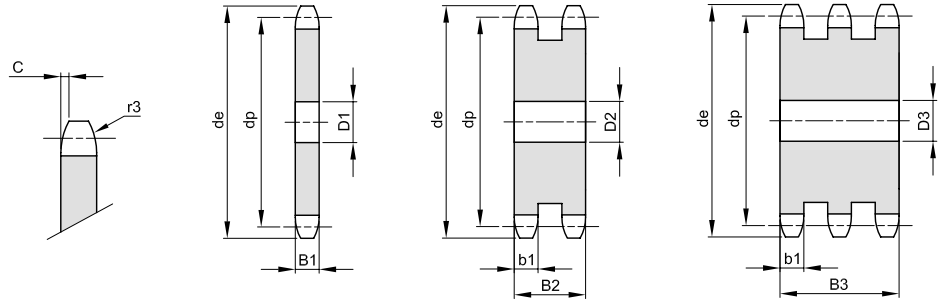

Z	de	dp	semplici			doppi			tripli		
			codice	D1	Kg.	codice	D2	Kg.	codice	D3	Kg.
8	96,0	82,96	201400008	16	0,55	202400008	20	1,28	203400008	20	2,02
9	106,5	92,84	201400009	16	0,73	202400009	20	1,74	203400009	20	2,79
10	117,0	102,74	201400010	16	0,93	202400010	20	2,28	203400010	20	3,77
11	127,0	112,68	201400011	20	1,13	202400011	20	2,89	203400011	25	4,53
12	137,0	122,68	201400012	20	1,38	202400012	20	3,56	203400012	25	5,64
13	147,5	132,65	201400013	20	1,65	202400013	20	4,31	203400013	25	4,87
14	157,6	142,68	201400014	20	1,94	202400014	20	5,12	203400014	25	8,20
15	167,7	152,72	201400015	20	2,26	202400015	20	6,00	203400015	25	9,65
16	177,7	162,75	201400016	20	2,60	202400016	30	6,78	203400016	30	11,07
17	187,7	172,78	201400017	20	2,96	202400017	30	7,80	203400017	30	12,75
18	197,8	182,85	201400018	20	3,34	202400018	30	8,89	203400018	30	14,54
19	207,9	192,91	201400019	20	3,75	202400019	30	10,05	203400019	30	16,45
20	217,9	202,98	201400020	20	4,30	202400020	30	11,27	203400020	30	18,47
21	228,0	213,04	201400021	25	4,62	202400021	30	12,56	203400021	30	20,62
22	238,1	223,11	201400022	25	5,09	202400022	30	13,93	203400022	30	22,87
23	248,2	233,17	201400023	25	5,60	202400023	30	15,36	203400023	30	25,24
24	258,3	243,23	201400024	25	6,18	202400024	30	16,86	203400024	30	27,72
25	268,4	253,33	201400025	25	6,67	202400025	30	18,43	203400025	30	30,32
26	278,4	263,40	201400026	30	7,21	202400026	30	20,07	203400026	30	33,03
27	288,5	273,48	201400027	30	7,81	202400027	30	21,17	203400027	30	35,86
28	298,5	283,56	201400028	30	8,43	202400028	30	23,56	203400028	30	38,80
29	308,6	293,65	201400029	30	9,07	202400029	30	25,39			
30	318,7	303,75	201400030	30	9,73	202400030	30	27,30	203400030	30	45,03
31	328,8	313,85	201400031	30	10,42	202400031	30	29,29			
32	338,9	323,91	201400032	30	11,13	202400032	30	31,34	203400032	30	51,72
33	349,0	334,01	201400033	30	11,87						
34	359,1	344,10	201400034	30	12,63	202400034	30	35,64	203400034	30	58,86
35	369,2	354,20	201400035	30	13,41	202400035	30	37,90	203400035	30	62,60
36	379,2	364,30	201400036	30	14,22	202400036	30	40,22	203400036	30	66,46
37	389,3	374,39	201400037	30	15,04						
38	399,4	384,49	201400038	30	15,90	202400038	30	45,08	203400038	30	74,52
39	409,5	394,59	201400039	30	16,77						
40	419,6	404,66	201400040	30	17,67	202400040	30	50,21	203400040	30	83,04
41	430,7	414,78	201400041	30	18,59						
42	440,8	424,88	201400042	30	19,54	202400042	30	55,62			
43	450,9	434,97	201400043	30	20,50						
44	461,0	445,07	201400044	30	21,50						
45	471,1	455,17	201400045	30	22,51	202400045	30	64,25	203400045	40	105,96
46	481,2	465,26	201400046	30	23,55	202400046	30	67,26			
48	501,4	485,46	201400048	30	25,70	202400048	30	73,49			
50	521,6	505,65	201400050	30	27,93	202400050	30	80,00	203400050	40	132,13
52	541,8	525,84	201400052	30	30,27	202400052	40	86,55			
54	562,0	546,07	201400054	30	32,69						



CORONE PER CATENE A RULLI - DIN 8187 - ISO 606
PLATE WHEELS FOR ROLLER CHAINS - DIN 8187 - ISO 606

1"1/4 x 3/4"
31,75 x 19,56 mm
 Rullo 19,05 mm
20B - 1 - 2 - 3

B1	B2	B3	b1	C	r3
18,5	54,6	91	18,2	3,5	32

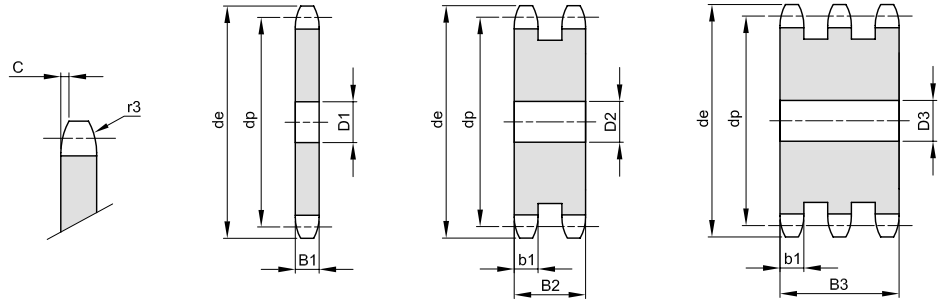

Z	de	dp	semplici			doppi			tripli		
			codice	D1	Kg.	codice	D2	Kg.	codice	D3	Kg.
55	572,1	556,16	201400055	30	33,94				203400055	40	161,16
56	582,2	566,26	201400056	30	35,21						
57	592,3	576,36	201400057	30	36,51	202400057	40	104,71	203400057	40	173,58
58	602,4	586,45	201400058	30	37,82						
60	622,6	606,65	201400060	30	40,53	202400060	40	116,43	203400060	40	193,06
64	663,0	647,06	201400064	30	46,22						
65	673,1	657,16	201400065	30	47,70	202400065	40	137,34	203400065	40	227,83
70	723,6	707,67	201400070	30	55,45	202400070	40	159,97	203400070	40	265,46
75	774,2	758,19	201400075	30	63,79						
76	784,3	768,32	201400076	30	66,53	202400076	40	189,39	203400076	40	314,39
80	824,7	808,72	201400080	30	72,71	202400080	40	210,38			
85	875,2	859,25	201400085	30	82,21						
90	925,7	909,76	201400090	30	92,30						
95	976,2	960,28	201400095	30	102,96	202400095	40	298,90			
100	1026,7	1010,79	201400100	40	114,13						
114	1168,2	1152,26	201400114	40	148,73	202400114	40	433,24	203400114	40	720,16



CORONE PER CATENE A RULLI - DIN 8187 - ISO 606

PLATE WHEELS FOR ROLLER CHAINS - DIN 8187 - ISO 606

1"1/2 x 1"
38,1 x 25,4 mm
 Rullo 25,4 mm
24B - 1 - 2 - 3

B1	B2	B3	b1	C	r3
24,1	72	120,3	23,6	4	38

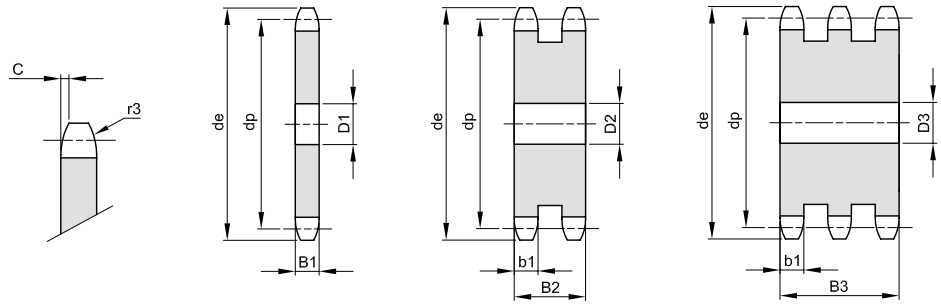

Z	de	dp	semplici			doppi			tripli		
			codice	D1	Kg.	codice	D2	Kg.	codice	D3	Kg.
8	113,0	99,55	201420008	20	1,00	202420008	25	2,31	203420008	25	3,67
9	125,0	111,40	201420009	20	1,32	202420009	25	3,18	203420009	25	5,10
10	137,0	123,29	201420010	20	1,69	202420010	25	4,19	203420010	25	6,75
11	149,0	135,21	201420011	25	2,07	202420011	25	5,33	203420011	30	8,42
12	161,0	147,22	201420012	25	2,53	202420012	25	6,59	203420012	30	10,50
13	173,0	159,18	201420013	25	3,03	202420013	25	7,99	203420013	30	12,81
14	185,0	171,22	201420014	25	3,57	202420014	25	9,52	203420014	30	15,33
15	197,0	183,26	201420015	25	4,16	202420015	25	11,18	203420015	30	18,08
16	209,0	195,30	201420016	25	4,79	202420016	30	12,85	203420016	30	21,04
17	221,0	207,34	201420017	25	5,47	202420017	30	14,77	203420017	30	24,22
18	233,0	219,42	201420018	25	6,19	202420018	30	16,82	203420018	30	27,61
19	245,5	231,49	201420019	25	6,95	202420019	30	19,00	203420019	30	31,23
20	257,5	243,57	201420020	25	7,76	202420020	30	21,31	203420020	30	35,06
21	270,5	255,65	201420021	30	8,57	202420021	30	23,75	203420021	40	38,60
22	282,5	267,73	201420022	30	9,46	202420022	30	26,33	203420022	40	42,87
23	294,5	279,80	201420023	30	10,40	202420023	30	29,03	203420023	40	47,36
24	307,0	291,88	201420024	30	11,50	202420024	30	31,86	203420024	40	52,07
25	319,0	304,00	201420025	30	12,41	202420025	30	34,83	203420025	40	56,99
26	331,0	316,08	201420026	30	13,47	202420026	30	37,93	203420026	40	62,14
27	343,0	328,19	201420027	30	14,59	202420027	30	41,15	203420027	40	67,50
28	355,0	340,27	201420028	30	15,74	202420028	30	44,51	203420028	40	73,08
29	367,5	352,38	201420029	30	16,94	202420029	30	48,00			
30	379,5	364,50	201420030	30	18,91	202420030	30	51,61	203420030	40	84,90
31	391,5	376,62	201420031	30	19,47	202420031	40	55,05			
32	403,5	388,69	201420032	30	20,80	202420032	40	58,93	203420032	40	97,59
33	415,5	400,81	201420033	30	22,18	202420033	40	62,94			
34	428,0	412,93	201420034	30	23,60	202420034	40	67,08			
35	440,0	425,04	201420035	30	25,06	202420035	40	71,35	203420035	40	118,26
36	452,0	437,16	201420036	30	26,60	202420036	40	75,75			
37	464,0	449,27	201420037	30	28,12	202420037	40	80,28			
38	476,5	461,39	201420038	30	29,71	202420038	40	84,95	203420038	40	140,90
40	501,5	485,62	201420040	30	33,03	202420040	40	94,66	203420040	40	158,08
41	513,5	497,74	201420041	30	34,75						
42	525,5	509,85	201420042	30	36,52	202420042	40	104,90			
45	562,0	546,20	201420045	30	42,08	202420045	40	121,24	203420045	40	201,37
46	574,0	558,32	201420046	30	44,03						
48	598,5	582,55	201420048	30	48,04	202420048	40	138,75	203420048	40	230,56
50	622,5	606,78	201420050	30	52,24	202420050	40	151,08	203420050	40	251,11
52	647,0	631,01	201420052	30	56,60						
54	671,0	655,25	201420054	30	61,14						
55	683,5	667,40	201420055	30	63,48						
56	695,5	679,50	201420056	30	65,86						
57	707,5	691,63	201420057	30	68,28	202420057	40	198,34	203420057	40	329,92



CORONE PER CATENE A RULLI - DIN 8187 - ISO 606

PLATE WHEELS FOR ROLLER CHAINS - DIN 8187 - ISO 606

1"3/4 x 1"1/4
44,45 x 30,99 mm
 Rullo 27,94 mm
28B - 1 - 2 - 3

B1	B2	B3	b1	C	r3
29,4	88,4	148	28,8	5	44

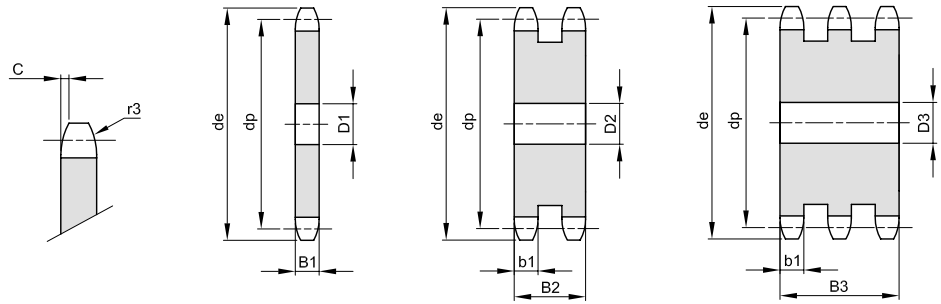

Z	de	dp	semplici			doppi			tripli		
			codice	D1	Kg.	codice	D2	Kg.	codice	D3	Kg.
8	132,0	116,15	201440008	20	1,71	202440008	25	4,01	203440008	25	6,39
9	146,0	129,96	201440009	20	2,26	202440009	25	5,48	203440009	25	8,80
10	160,0	143,85	201440010	20	2,88	202440010	25	7,17	203440010	25	11,56
11	174,0	157,77	201440011	25	3,53	202440011	30	8,92	203440011	30	14,44
12	188,0	171,74	201440012	25	4,29	202440012	30	11,04	203440012	30	17,93
13	204,0	185,75	201440013	25	5,12	202440013	30	13,38	203440013	30	21,79
14	218,0	199,76	201440014	25	6,03	202440014	30	15,94	203440014	30	26,02
15	232,0	213,79	201440015	25	7,01	202440015	30	18,72	203440015	30	30,61
16	246,0	227,84	201440016	30	8,02	202440016	30	21,71	203440016	30	35,57
17	260,0	241,90	201440017	30	9,14	202440017	30	24,92	203440017	30	40,89
18	274,0	255,98	201440018	30	10,34	202440018	30	28,36	203440018	30	46,58
19	289,0	270,06	201440019	30	11,61	202440019	30	32,00	203440019	30	52,64
20	303,0	284,15	201440020	30	12,95	202440020	30	35,87	203440020	30	59,06
21	317,0	298,24	201440021	30	14,37	202440021	30	39,96	203440021	40	65,20
22	331,0	312,34	201440022	30	15,86	202440022	30	44,26			
23	345,0	326,44	201440023	30	17,42	202440023	30	48,78	203440023	40	79,87
24	359,0	340,55	201440024	30	19,05						
25	373,0	354,66	201440025	30	20,76	202440025	30	58,50	203440025	40	95,99
26	387,0	368,77	201440026	30	22,54	202440026	40	63,28			
27	401,0	382,88	201440027	30	24,39						
28	416,0	397,00	201440028	30	26,32	202440028	40	74,29			
30	444,0	425,24	201440030	30	30,38	202440030	40	86,17	203440030	40	142,70
32	472,0	453,49	201440032	30	34,74						
34	500,0	481,75	201440034	30	39,38						
35	514,0	495,88	201440035	30	41,82	202440035	40	119,69			
36	529,0	510,01	201440036	30	44,32						
38	557,0	538,27	201440038	30	49,55	202440038	40	142,42	203440038	40	236,43
40	585,0	566,54	201440040	30	55,07	202440040	40	158,67	203440040	40	263,52
45	656,0	637,22	201440045	30	70,13	202440045	40	203,10	203440045	40	337,73
50	726,0	707,91	201440050	30	87,01	202440050	40	252,99			
57	825,0	806,90	201440057	40	113,56	202440057	40	332,00	203440057	40	552,76
60	869,0	849,32	201440060	40	126,08						
76	1095,0	1075,62	201440076	40	203,89	202440076	40	600,35	203440076	40	1000,97



CORONE PER CATENE A RULLI - DIN 8187 - ISO 606

PLATE WHEELS FOR ROLLER CHAINS - DIN 8187 - ISO 606

2" x 1"1/4
50,8 x 30,99 mm
 Rullo 29,21 mm
32B - 1 - 2 - 3

B1	B2	B3	b1	C	r3
29,4	87,4	146	28,8	6	51

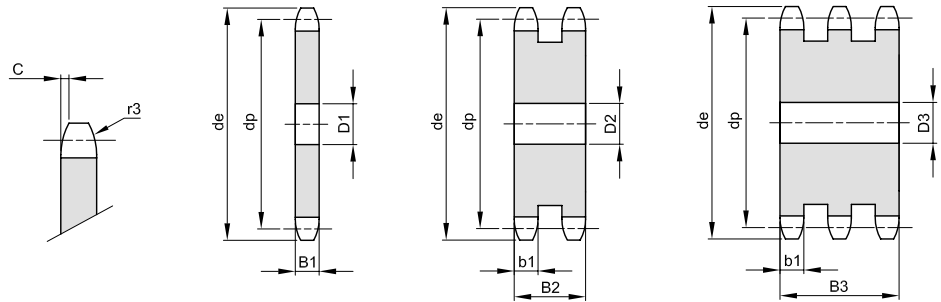

Z	de	dp	semplici			doppi			tripli		
			codice	D1	Kg.	codice	D2	Kg.	codice	D3	Kg.
8	152,0	132,74	201460008	25	2,27	202460008	25	5,53	203460008	25	8,83
9	168,0	148,54	201460009	25	2,99	202460009	25	7,46	203460009	25	11,99
10	184,0	164,39	201460010	25	3,81	202460010	25	9,68	203460010	25	15,63
11	200,0	180,31	201460011	30	4,67	202460011	35	11,86	203460011	35	19,20
12	216,0	196,29	201460012	30	5,67	202460012	35	14,64	203460012	35	23,78
13	235,0	212,29	201460013	30	6,77	202460013	35	17,70	203460013	35	28,83
14	251,0	228,29	201460014	30	7,97	202460014	35	21,05	203460014	35	34,35
15	267,0	244,30	201460015	30	9,26	202460015	35	24,68	203460015	35	40,34
16	283,0	260,40	201460016	30	10,64	202460016	40	28,38	203460016	40	46,47
17	299,0	276,46	201460017	30	12,12	202460017	40	32,57	203460017	40	53,40
18	315,0	292,55	201460018	30	13,69	202460018	40	37,05	203460018	40	60,80
19	331,0	308,66	201460019	30	15,36	202460019	40	41,80	203460019	40	68,68
20	347,0	324,71	201460020	40	16,99	202460020	40	46,84	203460020	40	77,02
21	363,0	340,82	201460021	40	18,85	202460021	40	52,15	203460021	40	85,84
22	379,0	356,98	201460022	40	20,80	202460022	40	57,75			
23	396,0	373,08	201460023	40	22,85	202460023	40	63,63	203460023	40	104,88
24	412,0	389,18	201460024	40	24,99	202460024	40	69,80			
25	428,0	405,33	201460025	40	27,23	202460025	40	76,24	203460025	40	125,81
26	444,0	421,44	201460026	40	29,56	202460026	40	82,97			
28	476,0	453,69	201460028	40	34,51	202460028	40	97,27			
30	508,0	486,00	201460030	40	39,84	202460030	40	112,70	203460030	40	186,37
32	541,0	518,27	201460032	40	45,54						
35	589,0	566,71	201460035	40	54,81	202460035	40	156,19	203460035	40	258,69
38	638,0	615,16	201460038	40	64,93	202460038	40	185,67	203460038	40	307,73
40	670,0	647,47	201460040	40	72,16	202460040	40	206,73			
45	751,0	728,24	201460045	40	91,87	202460045	40	265,32	203460045	40	438,64
50	832,0	809,04	201460050	40	113,96	202460050	40	328,95	203460050	40	549,27
57	945,0	922,16	201460057	40	148,86	202460057	40	431,27	203460057	40	716,72
60	993,0	970,65	201460060	40	165,24						
76	1252,0	1229,27	201460076	40	267,00	202460076	40	757,78	203460076	40	1295,64



CORONE DOPPIE PER DUE CATENE SEMPLICI - DIN 8187 - ISO 606

DOUBLE SIMPLE SPROCKETS - DIN 8187 - ISO 606

3/8" x 7/32"
9,525 x 5,72 mm
 Rullo 6,35 mm
06B - 1

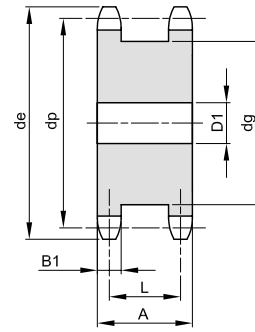
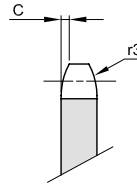

B1	C	r3
5,3	1	10

Materiale: Acciaio C45

Z	de	dp	codice	D1	dg	A	L	Kg.
13	43,5	39,80	204330013	10	29	23	17,7	0,14
14	46,5	42,80	204330014	10	32	23	17,7	0,17
15	49,5	45,81	204330015	10	35	23	17,7	0,20
16	52,5	48,82	204330016	12	38	23	17,7	0,23
17	55,5	51,83	204330017	12	41	23	17,7	0,26
18	58,6	54,85	204330018	12	44	23	17,7	0,30
19	61,6	57,87	204330019	12	47	23	17,7	0,34
20	64,6	60,89	204330020	15	50	23	17,7	0,38
21	67,6	63,91	204330021	15	53	23	17,7	0,43
23	73,7	69,95	204330023	15	60	23	17,7	0,54
25	79,7	76,00	204330025	15	66	23	17,7	0,65

1/2" x 5/16"
12,7 x 7,75 mm
 Rullo 8,51 mm
08B - 1

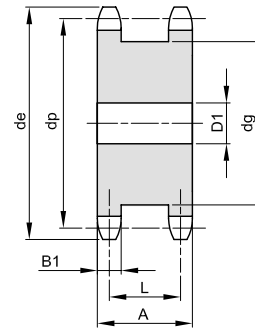
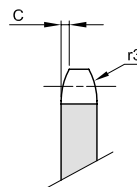

B1	C	r3
7,2	1,3	13

Materiale: Acciaio C45

Z	de	dp	codice	D1	dg	A	L	Kg.
12	53,9	49,07	204340012	15	36	30	22,8	0,27
13	57,9	53,06	204340013	15	40	30	22,8	0,33
14	61,9	57,07	204340014	15	44	30	22,8	0,40
15	65,9	61,09	204340015	15	48	30	22,8	0,47
16	69,9	65,10	204340016	15	52	30	22,8	0,55
17	74,0	69,11	204340017	15	56	30	22,8	0,64
18	78,0	73,14	204340018	15	60	30	22,8	0,73
19	82,0	77,16	204340019	15	64	30	22,8	0,84
20	86,0	81,19	204340020	15	68	30	22,8	0,93
21	90,1	85,22	204340021	15	72	30	22,8	1,03
23	98,1	93,27	204340023	15	80	30	22,8	1,28
25	106,2	101,33	204340025	15	88	30	22,8	1,54



CORONE DOPPIE PER DUE CATENE SEMPLICI - DIN 8187 - ISO 606

DOUBLE SIMPLE SPROCKETS - DIN 8187 - ISO 606

5/8" x 3/8"

15,875 x 9,65 mm

Rullo 10,16 mm

10B - 1

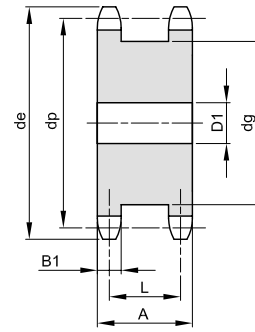
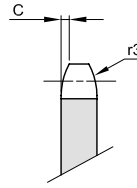

B1	C	r3
9,1	1,6	16

9,1	1,6	16
-----	-----	----

Materiale: Acciaio C45

Z	de	dp	codice	D1	dg	A	L	Kg.
12	68,2	61,34	204350012	15	45	34	24,9	0,51
13	73,2	66,32	204350013	15	50	34	24,9	0,62
14	78,2	71,34	204350014	15	55	34	24,9	0,74
15	83,2	76,36	204350015	15	60	34	24,9	0,87
16	88,3	81,37	204350016	15	65	34	24,9	1,02
17	93,3	86,39	204350017	15	70	34	24,9	1,17
18	98,3	91,42	204350018	15	75	34	24,9	1,34
19	103,3	96,45	204350019	20	80	34	24,9	1,49
20	108,4	101,49	204350020	20	85	34	24,9	1,68
21	113,4	106,52	204350021	20	90	34	24,9	1,88
23	123,5	116,58	204350023	20	100	34	24,9	2,30
25	133,6	126,66	204350025	20	110	34	24,9	2,77

3/4" x 7/16"

19,05 x 11,68 mm

Rullo 12,07 mm

12B - 1

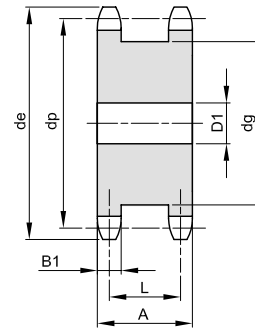
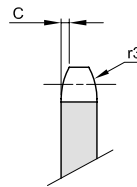

B1	C	r3
11,1	2	19

11,1	2	19
------	---	----

Materiale: Acciaio C45

Z	de	dp	codice	D1	dg	A	L	Kg.
12	81,8	73,60	204360012	20	53	44	32,9	0,91
13	87,8	79,59	204360013	20	59	44	32,9	1,12
14	93,8	85,61	204360014	20	65	44	32,9	1,33
15	99,8	91,63	204360015	20	71	44	32,9	1,57
16	105,8	97,65	204360016	20	77	44	32,9	1,84
17	111,9	103,67	204360017	20	83	44	32,9	2,12
18	117,9	109,71	204360018	20	89	44	32,9	2,42
19	123,9	115,75	204360019	20	95	44	32,9	2,75
20	130,0	121,78	204360020	20	101	44	32,9	3,09
21	136,0	127,82	204360021	25	107	44	32,9	3,42
23	148,1	139,90	204360023	25	119	44	32,9	4,21
25	160,2	152,00	204360025	25	131	44	32,9	5,07



CORONE DOPPIE PER DUE CATENE SEMPLICI - DIN 8187 - ISO 606
DOUBLE SIMPLE SPROCKETS - DIN 8187 - ISO 606

1" x 17,02 mm
25,4 x 17,02 mm
Rullo 15,88 mm
16B - 1

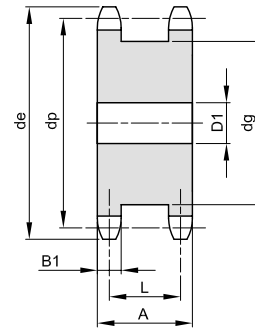
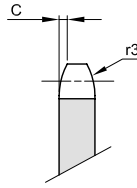

B1	C	r3
16,2	2,5	26

Materiale: Acciaio C45

Z	de	dp	codice	D1	dg	A	L	Kg.
12	109,7	98,14	204380012	20	72	68	51,8	2,58
13	117,7	106,12	204380013	20	80	68	51,8	3,14
14	125,7	114,15	204380014	20	88	68	51,8	3,76
15	133,7	122,17	204380015	20	96	68	51,8	4,44
16	141,8	130,20	204380016	25	104	68	51,8	5,09
17	149,8	138,22	204380017	25	112	68	51,8	5,87
18	157,8	146,28	204380018	25	120	68	51,8	6,70
19	165,9	154,33	204380019	30	128	68	51,8	7,53
21	182,0	170,43	204380021	30	144	68	51,8	9,48



PIGNONI TENDICATENA COMPLETI DI CUSCINETTO A SFERE CHAIN-STRETCHER SPROCKETS WITH BALL BEARING

I pignoni tendicatena vengono forniti pronti per il montaggio. Sono composti da una ruota dentata montata su un cuscinetto a sfere a doppio schermo di protezione che garantisce una maggiore resistenza all'usura. Il cuscinetto a sfere non richiede manutenzione. Le ruote sono in materiale C45 e dentate secondo riferimento DIN 8187, ISO 606.

I cuscinetti possono operare ad una temperatura da -20°C a $+120^{\circ}\text{C}$.

Our chain-stretcher sprockets with ball bearing are supplied "ready for mounting". They consist of a toothed wheel mounted on a ball bearing with double protection shield that guarantee a high resistance against break-age and wear. Bearing requires no maintenance.

The wheels are in C45 steel and they are toothed according to DIN 8187, ISO 606. The ball bearing can operate at a temperature from -20°C to $+120^{\circ}\text{C}$.

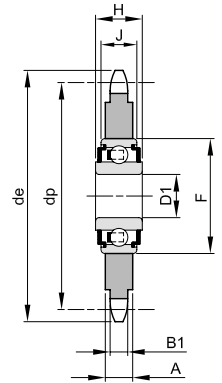
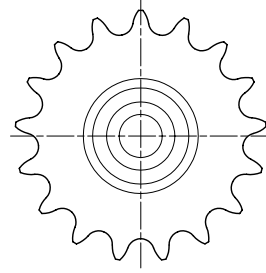

Materiale: Acciaio C45

Z	codice		passo	ISO	De	Dp	B1	A	D1	F	H	J	Kg.
	Nazionale	INA											
23	364308023	361308023	8 x 1/8"	05B-1	62,2	58,75	2,8	7,0	16 ^{+0,26} _{+0,13}	40	18,3	12	0,13
21	364330021	361330021	3/8" x 7/32"	06B-1	67,6	63,91	5,3	5,3	16 ^{+0,26} _{+0,13}	40	18,3	12	0,15
22	364330022		3/8" x 7/32"	06B-1	70,6	66,93	5,3	5,3	16 ^{+0,26} _{+0,13}	40	18,3	12	0,16
18	364341018	361341018	1/2" x 1/8"	081-1	79,4	73,14	3,0	7,0	16 ^{+0,26} _{+0,13}	40	18,3	12	0,18
15	364342015		1/2" x 3/16"	083-1	67,4	61,09	4,5	7,0	16 ^{+0,26} _{+0,13}	40	18,3	12	0,16
16	364342016		1/2" x 3/16"	083-1	71,4	65,10	4,5	7,0	16 ^{+0,26} _{+0,13}	40	18,3	12	0,17
18	364342018	361342018	1/2" x 3/16"	083-1	79,4	73,14	4,5	7,0	16 ^{+0,26} _{+0,13}	40	18,3	12	0,20
14	364340014		1/2" x 5/16"	08B-1	61,9	57,07	7,2	7,2	16 ^{+0,26} _{+0,13}	40	18,3	12	0,13
16	364340016	361340016	1/2" x 5/16"	08B-1	69,9	65,10	7,2	7,2	16 ^{+0,26} _{+0,13}	40	18,3	12	0,17
18	364340018	361340018	1/2" x 5/16"	08B-1	78,0	73,14	7,2	7,2	16 ^{+0,26} _{+0,13}	40	18,3	12	0,22
14	364350014	361350014	5/8" x 3/8"	10B-1	78,2	71,34	9,1	9,1	16 ^{+0,26} _{+0,13}	40	18,3	12	0,23
15	364350015		5/8" x 3/8"	10B-1	83,2	76,36	9,1	9,1	16 ^{+0,26} _{+0,13}	40	18,3	12	0,27
17	364350017	361350017	5/8" x 3/8"	10B-1	93,3	86,39	9,1	9,1	16 ^{+0,26} _{+0,13}	40	18,3	12	0,36
13	364360013	361360013	3/4" x 7/16"	12B-1	87,8	79,59	11,1	11,1	16 ^{+0,26} _{+0,13}	40	18,3	12	0,34
15	364360015	361360015	3/4" x 7/16"	12B-1	99,8	91,63	11,1	11,1	16 ^{+0,26} _{+0,13}	40	18,3	12	0,47
12	364380012	361380012	1" x 17,02	16B-1	109,7	98,14	16,2	16,2	20 ^{+0,10} ₋₀	47	17,7	14	0,72
13	364400013	361400013	1" 1/4 x 3/4"	20B-1	147,7	132,67	18,5	18,5	25 ^{+0,10} ₋₀	52	21,0	15	1,64



ELEMENTI DI FISSAGGIO PER PIGNONI TENDICATENA LOCKING PARTS FOR CHAIN STRETCHER SPROCKETS

Gli Elementi di fissaggio per tendicatena sono stati realizzati per facilitare e velocizzare il montaggio del Pignone Tendicatena.

Il set degli elementi è composto da: una vite con testa cava esagonale, una bussola per la guida del foro, un dado esagonale autobloccante.

The Locking Parts have been presented to make easier and faster the mounting of Chain Stretcher Sprockets.

Elements set: Exagonal head screw, hole guide bush, self-locking exagonal nut.

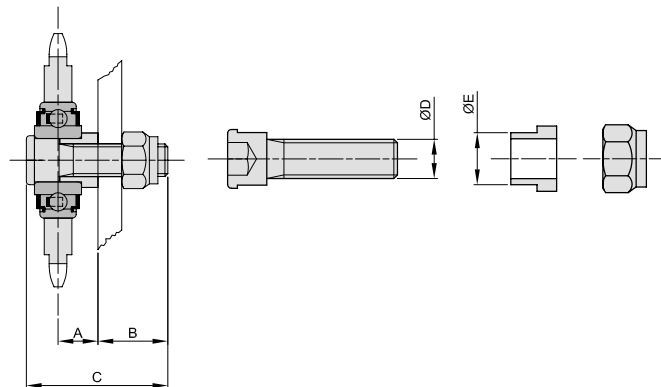

descrizione	codice	A	B	C	ØD	ØE	Kg
EFT-1	364999991	15	25	52	M12	16	0,08
EFT-2	364999992	25	28	66	M16	20	0,16



PIGNONI TENDICATENA COMPLETI DI CUSCINETTO A SFERE IN ACCIAIO INOX CHAIN-STRETCHER SPROCKETS WITH BALL BEARING IN STAINLESS STEEL

I pignoni tendicatena vengono forniti pronti per il montaggio. Sono composti da una ruota dentata montata su un cuscinetto a sfere a doppio schermo di protezione che garantisce una maggiore resistenza all'usura. Il cuscinetto a sfere non richiede manutenzione. Le ruote sono in materiale INOX e dentate secondo riferimento DIN 8187, ISO 606.
I cuscinetti possono operare ad una temperatura da -20°C a $+120^{\circ}\text{C}$.

Our chain-stretcher sprockets with ball bearing are supplied "ready for mounting". They consist of a toothed wheel mounted on a ball bearing with double protection shield that guarantee a high resistance against break-age and wear. Bearing requires no maintenance.

The wheels are in stainless steel and they are toothed according to DIN 8187, ISO 606. The ball bearing can operate at a temperature from -20°C to $+120^{\circ}\text{C}$.

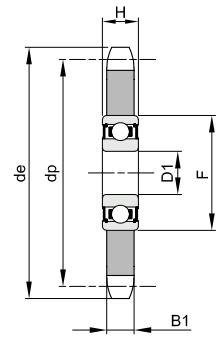
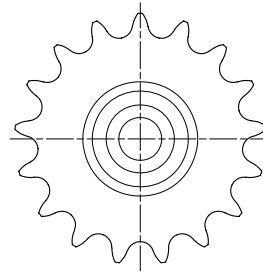

Materiale PIGNONE: INOX AISI 303
CUSCINETTO: INOX AISI 420

Z	codice	passo	ISO	De	Dp	B1	D1	F	H	Kg.
15	365330015	3/8" x 7/32"	06B-1	49,5	45,81	5,3	10 ⁺⁰ _{-0,008}	30	9	0,06
15	365340015	1/2" x 5/16"	08B-1	65,90	61,09	7,2	10 ⁺⁰ _{-0,008}	30	9	0,15
15	365350015	5/8" x 3/8"	10B-1	83,20	76,36	9,1	12 ⁺⁰ _{-0,008}	37	12	0,27
15	365360015	3/4" x 7/16"	12B-1	99,80	91,63	11,1	12 ⁺⁰ _{-0,008}	37	12	0,47
13	365380013	1" x 17,02	16B-1	117,70	106,12	16,2	20 ⁺⁰ _{-0,010}	52	15	0,88



RUOTE PER CATENE A CERNIERA - DIN 8153 WHEELS FOR TABLE TOP CHAINS - DIN 8153

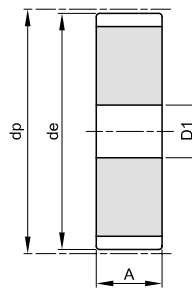
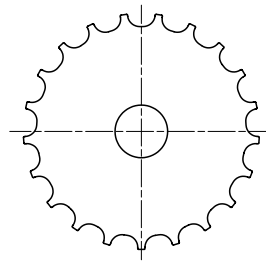

Materiale: Acciaio C45

Z	codice	passo	de	dp	D1	A	Kg.
15	351420015	1"1/2 (38,1)	92,0	93,67	16	43,5	1,86
17	351420017	1"1/2 (38,1)	104,7	105,47	16	43,5	2,34
19	351420019	1"1/2 (38,1)	116,6	117,34	16	43,5	3,10
21	351420021	1"1/2 (38,1)	129,7	129,26	20	43,5	3,79
23	351420023	1"1/2 (38,1)	141,6	141,22	20	43,5	4,46
25	351420025	1"1/2 (38,1)	153,6	153,20	20	43,5	5,50
27	351420027	1"1/2 (38,1)	165,6	165,21	20	43,5	6,31
29	351420029	1"1/2 (38,1)	177,7	177,23	20	43,5	7,31
31	351420031	1"1/2 (38,1)	189,7	189,27	20	43,5	8,63



PIGNONI TENDICATENA CON SFERE E VITE DI FISSAGGIO CHAIN-STRETCHER SPROCKETS WITH BALLS AND FASTENING BOLT

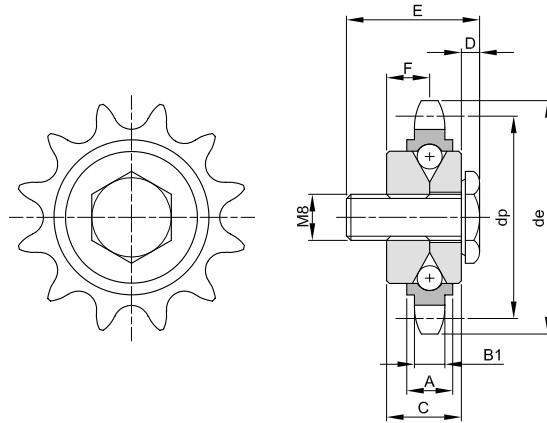

Materiale: Acciaio Cementato Temprato

Z	codice	passo	de	dp	A	B1	C	D	E	F	Kg.
12	371331012	3/8" x 5/32"	40	36,80	7	3,5	11,7	3	23	7,2	0,06
10	371341010	1/2" x 1/8"	46	41,10	7	3,0	11,7	3	23	7,2	0,06
10	371342010	1/2" x 3/16"	46	41,10	7	4,5	11,7	3	23	7,2	0,07



RUOTE LIBERE SEMPLICI SIMPLEX FREE WHEELS

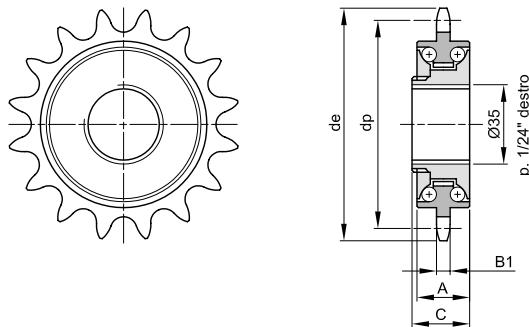

Z	codice	passo	de	dp	B1	A	C	Kg.
16	376341016	1/2" x 1/8"	71,4	65,10	3	14	15	0,14
18	376341018	1/2" x 1/8"	79,4	73,14	3	14	15	0,15



MOZZI SALDABILI CON PREFORO WELDING HUBS WITH PILOT BORE

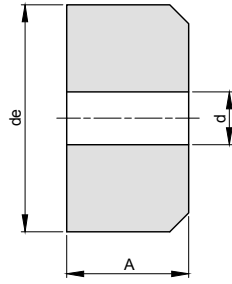

Materiale: Fe

codice	de	A	d	Kg.	codice	de	A	d	Kg.
497058030020	58	30	20	0,53	497145515030	145	51,5	30	6,33
497078030016	78	30	16	1,05	497150255030	150	25,5	30	3,35
497078030020	78	30	20	1,04	497150037030	150	37	30	4,87
497088035020	88	35	20	1,55	497160304030	160	30,4	30	4,56
497088035025	88	35	25	1,50	497160304040	160	30,4	40	4,43
497108034020	108	34	20	2,32	497160328030	160	32,8	30	4,79
497108034025	108	34	25	2,27	497160035040	160	35	40	5,09
497118050025	118	50	25	3,96	497160047030	160	47	30	7,09
497118050030	118	50	30	3,93	497160615030	160	61,5	30	9,27
497120197020	120	19,7	20	1,64	497168075030	168	75	30	12,55
497120197025	120	19,7	25	1,61	497178094040	178	94	40	17,30
497120255030	120	25,5	30	2,06	497180328030	180	32,8	30	6,27
497120338025	120	33,8	25	2,83	497180328040	180	32,8	40	6,13
497125328030	125	32,8	30	2,90	497180047030	180	47	30	9,00
497125042025	125	42	25	3,83	497180615040	180	61,5	40	11,60
497130203025	130	20,3	25	1,97	497200328040	200	32,8	40	7,67
497130203030	130	20,3	30	1,94	497200035040	200	35	40	8,17
497130223025	130	22,3	25	2,19	497200615040	200	61,5	40	14,43
497133515025	133	51,5	25	5,28	497218094040	218	94	40	26,38
497133515030	133	51,5	30	5,26	497220035040	220	35	40	9,95
497136304030	136	30,4	30	3,24	497220615040	220	61,5	40	17,60
497136032025	136	32	25	3,47	497238070040	238	70	40	23,57
497140204030	140	20,4	30	2,28					
497140223025	140	22,3	25	2,55					
497140255030	140	25,5	30	2,88					
497145328030	145	32,8	30	4,00					



MOZZI SMONTABILI PER BUSSOLA CONICA DEMOUNTABLE HUBS FOR TAPER BUSHES

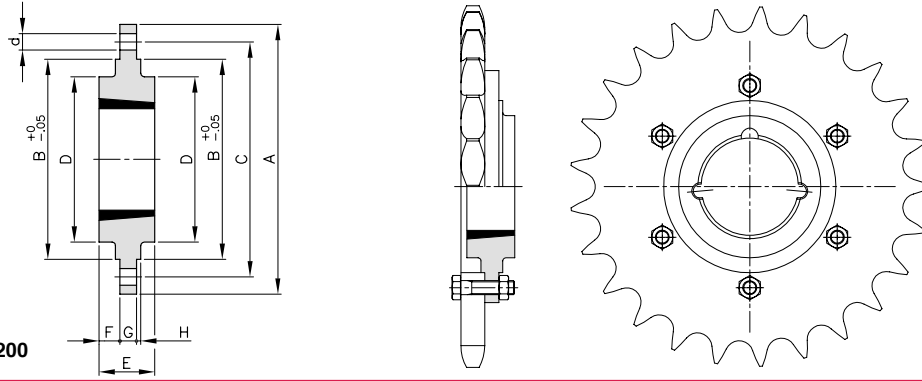

Materiale: Ghisa EN-GJL-200

descrizione	codice	bussola	foro MAX	A	B	C	D	E	F	G	H	d x n°viti	Kg.
MSM 120	495012000	1210	32	120	80	100	70	25	9,0	7,5	2,5	7,5 x 6	0,82
MSM 130	495013000	1610	42	130	90	110	80	25	9,0	7,5	2,5	7,5 x 6	0,95
MSM 145	495014500	2012	50	145	115	125	95	32	12,0	9,5	2,5	9,5 x 6	1,53
MSM 185	495018500	2517	65	185	130	155	115	45	19,0	12,5	2,5	11,5 x 6	3,14
MSM 220	495022000	3020	75	220	165	190	145	51	19,0	12,5	2,5	13,5 x 6	4,86
MSM 180	495018000	1210	32	180	90	135	75	25	9,3	6,5	2,5	7,5 x 6	1,54
MSM 200	495020000	1615	42	200	110	150	85	38	15,3	7,5	2,5	7,5 x 6	2,42
MSM 270	495027000	2012	50	270	140	190	110	32	11,8	8,5	2,5	9,5 x 6	4,44
MSM 340	495034000	2517	65	340	170	240	125	45	17,8	9,5	2,5	11,5 x 8	7,97
MSM 430	495043000	3020	75	430	220	300	160	51	18,8	13,5	2,5	13,5 x 8	16,80
MSM 485	495048500	3020	75	485	250	340	160	51	18,8	13,5	2,5	13,5 x 8	21,18



MOZZI SALDABILI PER BUSSOLA CONICA WELD - ON HUBS FOR TAPER BUSHES

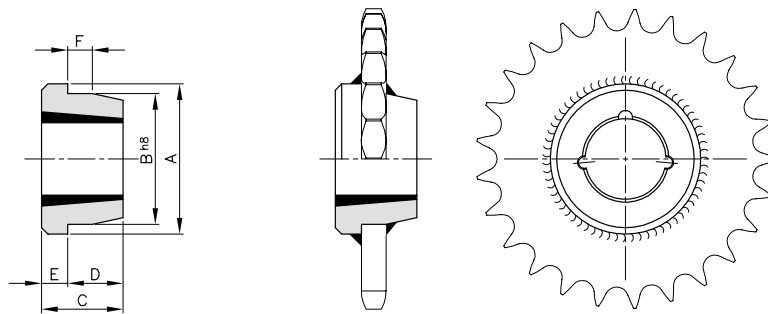

Materiale: Fe

descrizione	codice	bussola	foro MAX	A	B	C	D	E	F	Kg.
MSC 1210	496121000	1210	32	73	60	25	16	9	10	0,31
MSC 1215	496121500	1215	32	73	60	38	22	16	11	0,50
MSC 1610	496161000	1610	42	83	70	25	16	9	10	0,37
MSC 1615	496161500	1615	42	83	70	38	22	16	11	0,60
MSC 2012	496201200	2012	50	96	90	32	22	10	12	0,72
MSC 2517	496251700	2517	65	127	110	45	26	19	13	1,80
MSC 3020	496302000	3020	75	152	130	51	27	24	18	2,59
MSC 3030	496303000	3030	75	152	130	76	51	25	19	3,55
MSC 3525	496352500	3525	90	184	155	65	40	25	25	4,83
MSC 3535	496353500	3535	90	184	155	89	57	32	25	6,40
MSC 4040	496404000	4040	100	225	195	102	70	32	35	13,22
MSC 4545	496454500	4545	110	254	220	114	76	38	40	19,30
MSC 5050	496505000	5050	125	276	242	127	89	38	40	24,52



CORONE PER CATENE A RULLI - DIN 8188 - ISO 606 - ANSI B 29.1
PLATE WHEELS FOR ROLLER CHAINS - DIN 8188 - ISO 606 - ANSI B 29.1

ASA 40
12,7 x 7,95 mm
Rullo 7,95 mm
08A - 1

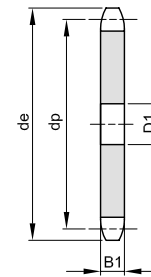
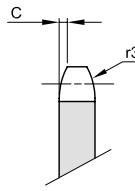

B1	B2	B3	b1	C	r3
7,2				1,6	13,5

Z	de	dp	semplici			doppi			Z	de	dp	semplici			doppi		
			codice	D1	Kg.	codice	D2	Kg.				codice	D1	Kg.	codice	D2	Kg.
8	39,3	33,18							51	212,9	206,30						
9	43,2	37,13							52	217,0	210,34						
10	47,2	41,10	231040010	8	0,06				53	221,0	214,37						
11	51,2	45,07							54	225,0	218,43						
12	55,2	49,07							55	229,1	222,46						
13	59,2	53,06	231040013	10	0,10				56	233,1	226,50						
14	63,2	57,07							57	237,2	230,54	231040057	20	2,25			
15	67,2	61,09							58	241,2	234,62						
16	71,2	65,10							59	245,2	238,62						
17	75,2	69,11	231040017	10	0,18				60	249,3	242,66						
18	79,2	73,14							62	257,4	250,74						
19	83,3	77,16	231040019	10	0,23				64	265,4	258,82						
20	87,3	81,19	231040020	10	0,27				65	269,5	262,86						
21	91,3	85,22	231040021	12	0,28				66	273,5	266,90						
22	95,4	89,24							68	281,6	274,99						
23	99,4	93,27							70	289,7	283,07						
24	103,4	97,29	231040024	12	0,38				72	297,8	291,16						
25	107,4	101,33							75	309,9	303,27						
26	111,5	105,36							76	313,9	307,33						
27	115,5	109,40							78	322,0	315,40						
28	119,5	113,42							80	330,1	323,48						
29	123,6	117,46							85	350,3	343,69						
30	127,6	121,50	231040030	16	0,58				90	370,5	363,90						
31	131,6	125,54							95	390,7	384,11						
32	135,7	129,56	231040032	16	0,68				100	410,9	404,31						
33	139,7	133,60							110	451,4	444,74						
34	143,8	137,64	231040034	16	0,78				114	467,5	460,90						
35	147,8	141,68	231040035	16	0,83				120	491,8	485,16						
36	151,8	145,72							125	512,0	505,37						
37	155,9	149,76															
38	159,9	153,80	231040038	16	0,98												
39	163,9	157,83															
40	168,0	161,87															
41	172,5	165,91															
42	176,6	169,95															
43	180,6	173,99															
44	184,6	178,03	231040044	20	1,32												
45	188,7	182,07															
46	192,7	186,10															
47	196,8	190,14															
48	200,8	194,18	231040048	20	1,58												
49	204,8	198,22															
50	208,9	202,26	231040050	20	1,73												



CORONE PER CATENE A RULLI - DIN 8188 - ISO 606 - ANSI B 29.1
PLATE WHEELS FOR ROLLER CHAINS - DIN 8188 - ISO 606 - ANSI B 29.1

ASA 50
15,875 x 9,53 mm
Rullo 10,16 mm
10A - 1

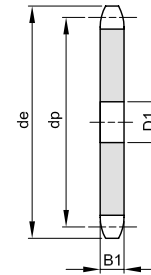
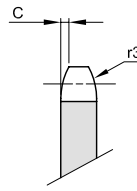

B1	B2	B3	b1	C	r3
8,7				2	17

Z	de	dp	semplici			doppi		
			codice	D1	Kg.	codice	D2	Kg.
8	48,4	41,48	201350008	10	0,06			
9	53,3	46,42	201350009	10	0,09			
10	58,3	51,37	201350010	10	0,11			
11	63,2	56,34	201350011	10	0,14			
12	68,2	61,34	201350012	10	0,17			
13	73,2	66,32	201350013	10	0,20			
14	78,2	71,34	201350014	12	0,23			
15	83,2	76,36	201350015	12	0,27			
16	88,3	81,37	201350016	12	0,31			
17	93,3	86,39	201350017	12	0,36			
18	98,3	91,42	201350018	12	0,41			
19	103,3	96,45	201350019	12	0,46			
20	108,4	101,49	201350020	12	0,51			
21	113,4	106,52	201350021	12	0,57			
22	118,4	111,55	201350022	12	0,62			
23	123,5	116,58	201350023	12	0,68			
24	128,5	121,62	201350024	12	0,75			
25	133,6	126,66	201350025	12	0,82			
26	138,6	131,70	201350026	16	0,88			
27	143,6	136,75	201350027	16	0,95			
28	148,7	141,78	201350028	16	1,03			
29	153,7	146,83	201350029	16	1,11			
30	158,8	151,87	201350030	16	1,19			
31	163,8	156,92	201350031	16	1,28			
32	168,9	161,95	201350032	16	1,36			
33	173,9	167,00	201350033	16	1,45			
34	178,9	172,05	201350034	16	1,55			
35	184,0	177,10	201350035	16	1,64			
36	189,0	182,15	201350036	20	1,73			
37	194,1	187,20	201350037	20	1,83			
38	199,1	192,24	201350038	20	1,94			
39	204,2	197,29	201350039	20	2,05			
40	209,2	202,34	201350040	20	2,16			
41	215,8	207,39	201350041	20	2,28			
42	220,8	212,44	201350042	20	2,39			
43	225,9	217,49	201350043	20	2,50			
44	230,9	222,53	201350044	20	2,63			
45	236,0	227,58	201350045	20	2,75			
46	241,0	232,63	201350046	20	2,88			
47	246,1	237,68	201350047	20	3,00			
48	251,1	242,73	201350048	20	3,14			
49	256,2	247,78	201350049	20	3,28			
50	261,2	252,82	201350050	20	3,42			

Z	de	dp	semplici			doppi		
			codice	D1	Kg.	codice	D2	Kg.
51	266,3	257,87	201350051	20	3,56			
52	271,3	262,92	201350052	20	3,70			
53	276,4	267,97	201350053	20	3,85			
54	281,4	273,03	201350054	20	4,00			
55	286,5	278,08	201350055	20	4,15			
56	291,5	283,13	201350056	25	4,30			
57	296,6	288,18	201350057	25	4,46			
58	301,6	293,23	201350058	25	4,62			
60	311,7	303,32	201350060	25	4,95			
62	321,8	313,43	201350062	25	5,30			
64	331,9	323,53	201350064	25	5,65			
65	337,0	328,58	201350065	25	5,83			
68	352,1	343,74	201350068	25	6,40			
70	362,2	353,84	201350070	25	6,79			
72	372,3	363,95	201350072	25	7,19			
75	387,5	379,09	201350075	25	7,81			
76	392,5	384,16	201350076	25	8,02			
78	402,6	394,25	201350078	25	8,46			
80	412,7	404,35	201350080	25	8,91			
85	438,0	429,62	201350085	30	10,06			
90	463,3	454,88	201350090	30	11,30			
95	488,5	480,14	201350095	30	12,61			
100	513,8	505,40	201350100	30	13,99			
110	564,3	555,92	201350110	30	16,97			
114	584,5	576,13	201350114	30	19,98			
120	614,8	606,44	201350120	30	22,17			
125	640,1	631,71	201350125	30	24,08			



CORONE PER CATENE A RULLI - DIN 8188 - ISO 606 - ANSI B 29.1
PLATE WHEELS FOR ROLLER CHAINS - DIN 8188 - ISO 606 - ANSI B 29.1

ASA 60
19,05 x 12,7 mm
Rullo 11,91 mm
12A - 1

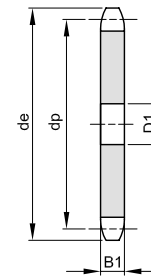
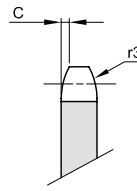

B1	B2	B3	b1	C	r3
11,6				2,4	20

Z	de	dp	semplici			doppi		
			codice	D1	Kg.	codice	D2	Kg.
8	58,1	49,78						
9	64,0	55,70						
10	70,0	61,64						
11	76,0	67,61						
12	81,9	73,60						
13	87,9	79,59	231060013	14	0,35			
14	94,0	85,61	231060014	14	0,41			
15	100,0	91,63	231060015	14	0,48			
16	106,0	97,65	231060016	14	0,55			
17	112,0	103,67	231060017	14	0,63			
18	118,0	109,71	231060018	14	0,71			
19	124,1	115,75						
20	130,1	121,78	231060020	14	0,92			
21	136,2	127,82	231060021	16	0,99			
22	142,2	133,86	231060022	16	1,09			
23	148,2	139,90	231060023	16	1,20			
24	154,3	145,94						
25	160,3	152,00	231060025	16	1,43			
26	166,4	158,04	231060026	16	1,56			
27	172,4	164,09	231060027	16	1,68			
28	178,5	170,13	231060028	16	1,82			
29	184,5	176,19	231060029	16	1,96			
30	190,6	182,25	231060030	16	2,10			
31	196,6	188,31	231060031	20	2,24			
32	202,7	194,35	231060032	20	2,39			
33	208,8	200,40						
34	214,8	206,46	231060034	20	2,71			
35	220,9	212,52	231060035	20	2,88			
36	226,9	218,58	231060036	20	3,06			
37	233,0	224,64						
38	239,0	230,69	231060038	20	3,42			
39	245,1	236,75						
40	251,1	242,81	231060040	20	3,85			
41	259,1	248,87						
42	265,2	254,93	231060042	25	4,19			
43	271,2	260,98						
44	277,3	267,03						
45	283,3	273,10						
46	289,4	279,16						
47	295,5	285,21						
48	301,5	291,27						
49	307,6	297,33						
50	313,6	303,39						
51	319,7	309,45						
52	325,8	315,50						
53	331,8	321,56						
54	337,9	327,64						
55	343,9	333,70						
56	350,0	339,75						
57	356,1	345,81						
58	362,1	351,87						
59	368,2	357,93						
60	374,2	363,99						
62	386,4	376,12						
64	398,5	388,24						
65	404,5	394,29						
66	410,6	400,35						
68	422,7	412,49						
70	434,9	424,60						
72	447,0	436,74						
75	465,2	454,91						
76	471,2	460,99						
78	483,3	473,10						
80	495,5	485,22						
85	525,8	515,55						
90	556,1	545,86						
95	586,4	576,17						
100	616,7	606,47						
110	677,4	667,11						
114	701,6	691,36						
120	738,0	727,74						
125	768,3	758,05						



CORONE PER CATENE A RULLI - DIN 8188 - ISO 606 - ANSI B 29.1
PLATE WHEELS FOR ROLLER CHAINS - DIN 8188 - ISO 606 - ANSI B 29.1

ASA 80
25,4 x 15,88 mm
Rullo 15,88 mm
16A - 1

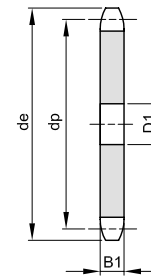
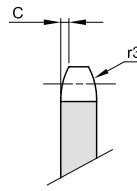

B1	B2	B3	b1	C	r3
14,6				3,2	27

Z	de	dp	semplici			doppi			Z	de	dp	semplici			doppi		
			codice	D1	Kg.	codice	D2	Kg.				codice	D1	Kg.	codice	D2	Kg.
8	77,9	66,37							51	426,5	412,60						
9	85,8	74,27							52	434,5	420,67						
10	93,8	82,19							53	442,5	428,75						
11	101,7	90,14							54	450,6	436,85						
12	109,7	98,14	231080012	16	0,77				55	458,7	444,93						
13	117,7	106,12							56	466,8	453,01						
14	125,7	114,15	231080014	16	1,01				57	474,9	461,07						
15	133,7	122,17							58	482,9	469,16						
16	141,8	130,20	231080016	20	1,43				59	491,0	477,24						
17	149,8	138,22	231080017	20	1,64				60	499,1	485,32						
18	157,8	146,28	231080018	20	1,85				62	515,3	501,50						
19	165,9	154,33	231080019	20	2,08				64	531,4	517,65						
20	173,9	162,38	231080020	20	2,12				65	539,5	525,73						
21	182,0	170,43	231080021	20	2,45				66	547,6	533,80						
22	190,1	178,48	231080022	20	2,84				68	563,8	549,98						
23	198,1	186,53	231080023	20	3,13				70	579,9	566,14						
24	206,2	194,59	231080024	20	3,42				72	596,1	582,32						
25	214,2	202,66							75	620,3	606,35						
26	222,3	210,72	231080026	20	4,05				76	628,4	614,65						
27	230,4	218,79							78	644,6	630,80						
28	238,4	226,85	231080028	20	4,73				80	660,7	646,96						
29	246,5	234,92	231080029	20	5,09				85	701,2	687,40						
30	254,6	243,00	231080030	20	5,46				90	741,6	727,81						
31	262,6	251,08							95	782,0	768,22						
32	270,7	259,13							100	822,4	808,63						
33	278,8	267,21	231080033	25	6,63				110	903,3	889,48						
34	286,9	275,28	231080034	25	7,06				114	935,6	921,81						
35	294,9	283,36	231080035	25	7,49				120	984,1	970,33						
36	303,0	291,44							125	1024,5	1010,73						
37	311,1	299,51															
38	319,2	307,59	231080038	25	8,88												
39	327,2	315,67															
40	335,3	323,73															
41	345,6	331,82															
42	353,7	339,90															
43	361,7	347,98															
44	369,8	356,06															
45	377,9	364,12															
46	386,0	372,21															
47	394,1	380,29															
48	402,1	388,36															
49	410,2	396,44															
50	418,3	404,52															



CORONE PER CATENE A RULLI - DIN 8188 - ISO 606 - ANSI B 29.1
PLATE WHEELS FOR ROLLER CHAINS - DIN 8188 - ISO 606 - ANSI B 29.1

ASA 100
31,75 x 19,05 mm
Rullo 19,05 mm
20A - 1

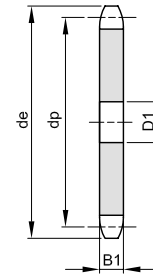
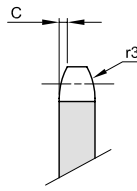

B1	B2	B3	b1	C	r3
17,6				4	33,5

Z	de	dp	semplici		doppi	
			codice	D1 Kg.	codice	D2 Kg.
8	96,0	82,96				
9	106,5	92,84				
10	117,0	102,74				
11	127,0	112,68				
12	137,0	122,68				
13	147,5	132,65				
14	157,6	142,68				
15	167,7	152,72				
16	177,7	162,75				
17	187,7	172,78	231100017	20 2,96		
18	197,8	182,85	231100018	20 3,28		
19	207,9	192,91				
20	217,9	202,98				
21	228,0	213,04	231100021	25 4,62		
22	238,1	223,11				
23	248,2	233,17				
24	258,3	243,23				
25	268,4	253,33				
26	278,4	263,40				
27	288,5	273,48				
28	298,5	283,56				
29	308,6	293,65				
30	318,7	303,75				
31	328,8	313,85				
32	338,9	323,91				
33	349,0	334,01				
34	359,1	344,10				
35	369,2	354,20				
36	379,2	364,30				
37	389,3	374,39				
38	399,4	384,49				
39	409,5	394,59				
40	419,6	404,66				
41	430,7	414,78				
42	440,8	424,88				
43	450,9	434,97				
44	461,0	445,07				
45	471,1	455,17				
46	481,2	465,26				
47	491,3	475,36				
48	501,4	485,46				
49	511,5	495,55				
50	521,6	505,65				

Z	de	dp	semplici		doppi	
			codice	D1 Kg.	codice	D2 Kg.
51	531,7	515,75				
52	541,8	525,84				
53	551,9	535,94				
54	562,0	546,07				
55	572,1	556,16				
56	582,2	566,26				
57	592,3	576,36				
58	602,4	586,45				
59	612,5	596,55				
60	622,6	606,65				
62	642,8	626,87				
64	663,0	647,06				
65	673,1	657,16				
66	683,2	667,26				
68	703,4	687,48				
70	723,6	707,67				
72	743,8	727,90				
75	774,2	758,19				
76	784,3	768,32				
80	824,7	808,72				
85	875,2	859,25				
90	925,7	909,76				
95	976,2	960,28				
100	1026,7	1010,79				
114	1168,2	1152,26				



CORONE PER CATENE A RULLI - DIN 8188 - ISO 606 - ANSI B 29.1
PLATE WHEELS FOR ROLLER CHAINS - DIN 8188 - ISO 606 - ANSI B 29.1

ASA 120

38,1 x 25,4 mm
Rullo 22,23 mm
24A - 1

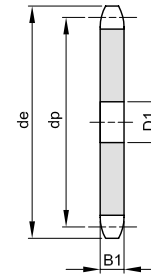
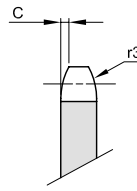

B1	B2	B3	b1	C	r3
23,5				4,8	40,5

Z	de	dp	semplici			doppi			Z	de	dp	semplici			doppi		
			codice	D1	Kg.	codice	D2	Kg.				codice	D1	Kg.	codice	D2	Kg.
8	113,0	99,55							51	635,0	618,89						
9	125,0	111,40	231120009	20	1,47				52	647,0	631,01						
10	137,0	123,29	231120010	20	1,85				53	659,0	643,13						
11	149,0	135,21	231120011	25	2,24				54	671,0	655,25						
12	161,0	147,22							55	683,5	667,40						
13	173,0	159,18	231120013	25	3,22				56	695,5	679,50						
14	185,0	171,22	231120014	25	3,68				57	707,5	691,63						
15	197,0	183,26	231120015	25	4,34				58	719,5	703,74						
16	209,0	195,30	231120016	25	4,88				59	731,5	715,86						
17	221,0	207,34	231120017	25	5,69				60	745,0	727,97						
18	233,0	219,42	231120018	25	6,29				62	769,0	752,24						
19	245,5	231,49							64	793,5	776,48						
20	257,5	243,57	231120020	25	7,95				65	805,5	788,59						
21	270,5	255,65							66	817,5	800,71						
22	282,5	267,73							68	842,0	824,98						
23	294,5	279,80							70	866,0	849,21						
24	307,0	291,88							72	890,5	873,48						
25	319,0	304,00	231120025	30	12,25				75	926,5	909,83						
26	331,0	316,08							76	939,0	921,98						
27	343,0	328,19							80	987,5	970,44						
28	355,0	340,27							85	1048,0	1031,10						
29	367,5	352,38							90	1108,0	1091,71						
30	379,5	364,50															
31	391,5	376,62															
32	403,5	388,69															
33	415,5	400,81															
34	428,5	412,93															
35	440,0	425,04	231120035	30	24,65												
36	452,0	437,16															
37	464,0	449,27															
38	476,5	461,39															
39	488,5	473,50															
40	501,5	485,62															
41	513,5	497,74															
42	525,5	509,85															
43	538,0	521,97															
44	550,0	534,08															
45	562,0	546,20															
46	574,0	558,32															
47	586,5	570,43															
48	598,5	582,55															
49	610,5	594,66															
50	622,5	606,78															



CORONE PER CATENE A RULLI - DIN 8188 - ISO 606 - ANSI B 29.1
PLATE WHEELS FOR ROLLER CHAINS - DIN 8188 - ISO 606 - ANSI B 29.1

ASA 140
44,45 x 25,4 mm
Rullo 25,4 mm
28A - 1

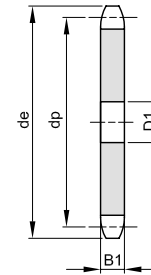
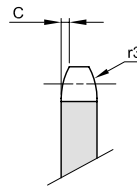

B1	B2	B3	b1	C	r3
23,5				5,8	47,5

Z	de	dp	semplici			doppi			Z	de	dp	semplici			doppi		
			codice	D1	Kg.	codice	D2	Kg.				codice	D1	Kg.	codice	D2	Kg.
8	132,0	116,15															
9	146,0	129,96	231140009	20	2,07												
10	160,0	143,85	231140010	20	2,59												
11	174,0	157,77	231140011	25	3,04												
12	188,0	171,74	231140012	25	3,72												
13	204,0	185,75	231140013	25	4,37												
14	218,0	199,76	231140014	25	5,16												
15	232,0	213,79															
16	246,0	227,84	231140016	30	6,85												
17	260,0	241,90	231140017	30	7,68												
18	274,0	255,98															
19	289,0	270,06															
20	303,0	284,15															
21	317,0	298,24															
22	331,0	312,34															
23	345,0	326,44															
24	359,0	340,55															
25	373,0	354,66															
26	387,0	368,77															
27	401,0	382,88															
28	416,0	397,00															
29	430,0	411,12															
30	444,0	425,24															
31	458,0	439,37															
32	472,0	453,49															
33	486,0	467,62															
34	500,0	481,75															
35	514,0	495,88															
36	529,0	510,01															
37	543,0	524,13															
38	557,0	538,27															
39	571,0	552,40															
40	585,0	566,54															
45	656,0	637,22															
50	726,0	707,91															
57	825,0	806,90															
60	869,0	849,32															
76	1095,0	1075,62															





CORONE PER CATENE TRASPORTO

PLATE WHEELS FOR CONVEYOR CHAINS

PASSO 50
RULLO 25

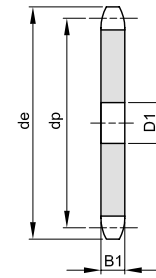
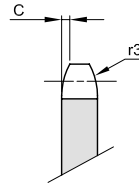

B1	C	r3
10,5	3	50

Materiale: Fe

Z	de	dp	codice	D1	Kg.	Z	de	dp	codice	D1	Kg.
6	121,0	100,00	331555006	20	0,55	21	356,5	335,45	331555021	30	7,39
7	136,0	115,24	331555007	20	0,76	22	372,5	351,35	331555022	30	7,88
8	151,5	130,65	331555008	20	0,92	23	388,0	367,20	331555023	30	8,15
9	167,0	146,20	331555009	20	1,15	24	404,0	383,05	331555024	30	8,68
10	183,0	161,80	331555010	25	1,52	25	420,0	398,95	331555025	30	9,66
11	198,5	177,50	331555011	25	1,86	28	467,5	446,55	331555028	30	13,15
12	214,0	193,20	331555012	25	2,20	30	499,5	478,35	331555030	30	14,82
13	230,0	208,95	331555013	25	2,56	35	579,0	557,80	331555035	30	19,10
14	245,5	224,70	331555014	25	2,99	38	626,5	605,45	331555038	30	21,50
15	261,5	240,45	331555015	25	3,40						
16	277,5	256,30	331555016	30	3,94						
17	293,0	272,11	331555017	30	4,73						
18	309,0	287,95	331555018	30	4,94						
19	325,0	303,80	331555019	30	6,00						
20	340,5	319,60	331555020	30	6,10						

PASSO 50
RULLO 31

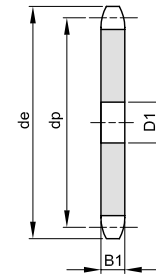
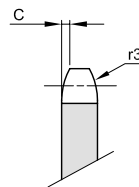

B1	C	r3
13,5	3	50

Materiale: Fe

Z	de	dp	codice	D1	Kg.	Z	de	dp	codice	D1	Kg.
6	120,0	100,00	331565006	20	0,61	21	355,5	335,45	331565021	30	8,65
7	135,0	115,24	331565007	20	0,86	22	371,5	351,35	331565022	30	9,44
8	150,5	130,65	331565008	20	1,16	23	387,0	367,20	331565023	30	10,28
9	166,0	146,20	331565009	20	1,48	24	403,0	383,05	331565024	30	11,25
10	182,0	161,80	331565010	25	1,83	25	419,0	398,95	331565025	30	12,30
11	197,5	177,50	331565011	25	2,27	26	435,0	414,80	331565026	30	13,34
12	213,0	193,20	331565012	25	2,72	28	466,5	446,55	331565028	30	15,52
13	229,0	208,95	331565013	25	3,21	30	498,5	478,35	331565030	30	17,95
14	244,5	224,70	331565014	25	3,71	32	530,0	510,10	331565032	30	20,46
15	260,5	240,45	331565015	25	4,33	38	625,5	605,45	331565038	30	26,60
16	276,5	256,30	331565016	30	4,94						
17	292,0	272,11	331565017	30	5,58						
18	308,0	287,95	331565018	30	6,30						
19	324,0	303,80	331565019	30	7,04						
20	339,5	319,60	331565020	30	7,82						



CORONE PER CATENE TRASPORTO

PLATE WHEELS FOR CONVEYOR CHAINS

PASSO 50,8
RULLO 30

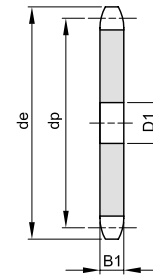
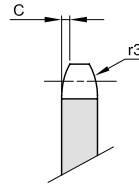

B1	C	r3
8,8	3	50

Materiale: Fe

Z	de	dp	codice	D1	Kg.	Z	de	dp	codice	D1	Kg.
8	149,0	132,74	331570008	20	0,67						
10	182,0	164,39	331570010	20	1,22						
12	214,0	196,27	331570012	25	1,81						
14	247,0	228,29	331570014	25	2,49						
16	279,0	260,39	331570016	30	3,24						

PASSO 75
RULLO 25

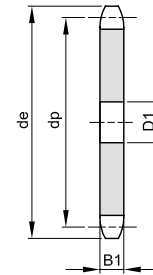
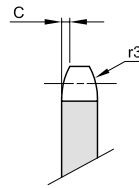

B1	C	r3
10,5	3	50

Materiale: Fe

Z	de	dp	codice	D1	Kg.	Z	de	dp	codice	D1	Kg.
8	211,0	195,98	331600008	25	2,47						
10	258,0	242,70	331600010	25	3,77						

PASSO 75
RULLO 31

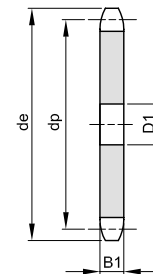
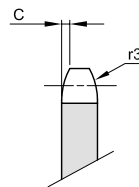

B1	C	r3
13,5	3	50

Materiale: Fe

Z	de	dp	codice	D1	Kg.	Z	de	dp	codice	D1	Kg.
6	168,0	150,00	331610006	25	1,68	13	333,0	313,42	331610013	30	7,80
8	215,0	195,98	331610008	25	2,94	14	357,0	337,05	331610014	30	9,12
9	238,0	219,30	331610009	25	3,78	15	380,0	360,73	331610015	30	10,42
10	261,0	242,70	331610010	30	4,50	16	404,0	384,45	331610016	30	11,98
11	286,0	266,25	331610011	30	5,57	20	499,0	479,40	331610020	30	18,35
12	309,0	289,80	331610012	30	6,70	21	523,0	503,17	331610021	30	20,62



CORONE PER CATENE TRASPORTO

PLATE WHEELS FOR CONVEYOR CHAINS

PASSO 100
RULLO 31

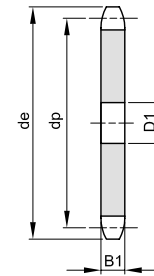
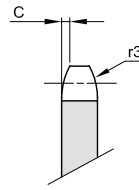

B1	C	r3
13,5	3	50

Materiale: Fe

Z	de	dp	codice	D1	Kg.	Z	de	dp	codice	D1	Kg.
6	218,0	200,00	331655006	25	3,32						
7	249,0	230,48	331655007	25	4,32						
8	280,0	261,31	331655008	30	5,50						
9	311,0	292,40	331655009	30	6,95						
10	342,0	323,61	331655010	30	8,57						
11	375,0	354,95	331655011	30	10,29						
12	406,0	386,40	331655012	30	12,45						
13	437,0	417,90	331655013	30	14,45						
14	469,0	449,40	331655014	30	16,84						
15	500,0	480,97	331655015	30	19,36						
16	532,0	512,60	331655016	30	21,76						

PASSO 100
RULLO 40

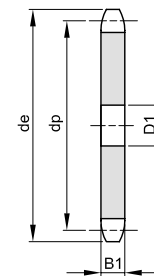
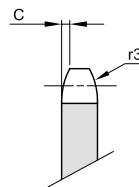

B1	C	r3
20	3	50

Materiale: Fe

Z	de	dp	codice	D1	Kg.	Z	de	dp	codice	D1	Kg.
6	220,0	200,00	331660006	25	4,54						
7	251,0	230,48	331660007	25	6,10						
8	283,0	261,31	331660008	30	7,87						
9	314,0	292,40	331660009	30	9,94						
10	345,0	323,61	331660010	30	12,25						
11	378,0	354,95	331660011	30	14,72						
12	409,0	386,40	331660012	30	17,48						
13	441,0	417,90	331660013	30	20,90						



PIGNONI PER CATENE TRASPORTO SPROCKETS FOR CONVEYOR CHAINS

**PASSO 50
RULLO 25**

B1	C	r3
10,5	3	50

Materiale: Fe

Z	de	dp	codice	dm	D1	A	Kg.
6	121,0	100,00	332555006	58	20	40,5	1,11
7	136,0	115,24	332555007	58	20	40,5	1,37
8	151,5	130,65	332555008	58	20	40,5	1,55
9	167,0	146,20	332555009	58	20	40,5	1,89
10	183,0	161,80	332555010	88	25	45,5	3,10
11	198,5	177,50	332555011	88	25	45,5	3,44
12	214,0	193,20	332555012	88	25	45,5	3,79
13	230,0	208,95	332555013	88	25	45,5	4,17
14	245,5	224,70	332555014	88	25	45,5	4,63
15	261,5	240,45	332555015	88	25	45,5	5,09
16	277,5	256,30	332555016	118	30	60,5	8,26
17	293,0	272,11	332555017	118	30	60,5	9,10
18	309,0	287,95	332555018	118	30	60,5	9,26
19	325,0	303,80	332555019	118	30	60,5	10,32
20	340,5	319,60	332555020	118	30	60,5	10,42

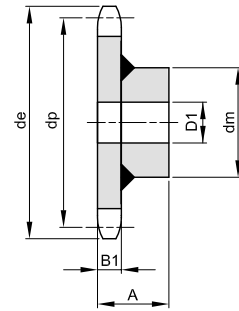
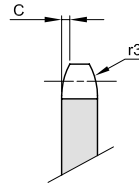

**PASSO 50
RULLO 31**

B1	C	r3
13,5	3	50

Materiale: Fe

Z	de	dp	codice	dm	D1	A	Kg.
6	120,0	100,00	332565006	58	20	43,5	1,18
7	135,0	115,24	332565007	58	20	43,5	1,44
8	150,5	130,65	332565008	58	20	43,5	1,72
9	166,0	146,20	332565009	58	20	43,5	2,05
10	182,0	161,80	332565010	88	25	48,5	3,40
11	197,5	177,50	332565011	88	25	48,5	3,80
12	213,0	193,20	332565012	88	25	48,5	4,30
13	229,0	208,95	332565013	88	25	48,5	4,78
14	244,5	224,70	332565014	88	25	48,5	5,37
15	260,5	240,45	332565015	88	25	48,5	5,98
16	276,5	256,30	332565016	118	30	63,5	9,05
17	292,0	272,11	332565017	118	30	63,5	9,60
18	308,0	287,95	332565018	118	30	63,5	10,30
19	324,0	303,80	332565019	118	30	63,5	11,10
20	339,5	319,60	332565020	118	30	63,5	11,90

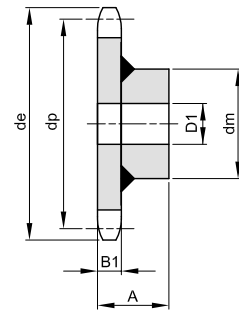
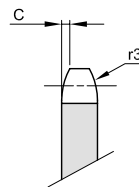

Z	de	dp	codice	dm	D1	A	Kg.
21	355,5	335,45	332565021	118	30	63,5	12,75
22	371,5	351,35	332565022	118	30	63,5	13,54
23	387,0	367,20	332565023	118	30	63,5	14,38
24	403,0	383,05	332565024	118	30	63,5	15,35
25	419,0	398,95	332565025	118	30	63,5	16,40
26	435,0	414,80	332565026	133	30	65,0	18,81
28	466,5	446,55	332565028	133	30	65,0	21,00
30	498,5	478,35	332565030	133	30	65,0	23,42
32	530,0	510,10	332565032	133	30	65,0	25,93
38	625,5	605,45	332565038	133	30	65,0	32,10



PIGNONI PER CATENE TRASPORTO SPROCKETS FOR CONVEYOR CHAINS

**PASSO 50,8
RULLO 30**

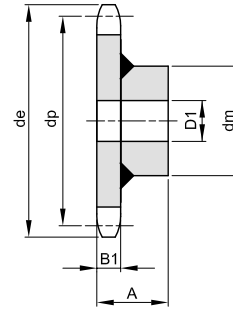
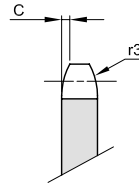

B1	C	r3
8,8	3	50

Materiale: Fe

Z	de	dp	codice	dm	D1	A	Kg.
8	149,0	132,74	332570008	58	20	39	1,35
10	182,0	164,39	332570010	88	20	44	2,85
12	214,0	196,27	332570012	88	25	44	3,37
14	247,0	228,29	332570014	88	25	44	4,08
16	279,0	260,39	332570016	118	30	59	7,34

Z	de	dp	codice	dm	D1	A	Kg.

**PASSO 75
RULLO 25**

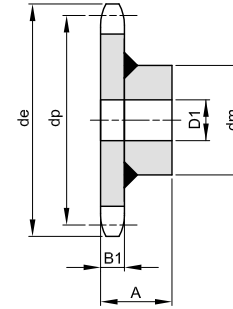
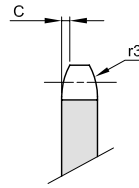

B1	C	r3
10,5	3	50

Materiale: Fe

Z	de	dp	codice	dm	D1	A	Kg.
8	211,0	195,98	332600008	88	25	45,5	4,07
10	258,0	242,70	332600010	118	25	60,5	7,87

Z	de	dp	codice	dm	D1	A	Kg.

**PASSO 75
RULLO 31**

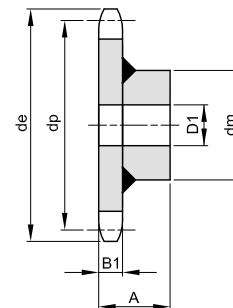
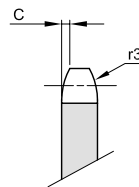

B1	C	r3
13,5	3	50

Materiale: Fe

Z	de	dp	codice	dm	D1	A	Kg.
6	168,0	150,00	332610006	88	25	48,5	3,26
8	215,0	195,98	332610008	88	25	48,5	4,52
9	238,0	219,30	332610009	88	25	48,5	5,36
10	261,0	242,70	332610010	118	30	63,5	8,70
11	286,0	266,25	332610011	118	30	63,5	9,60
12	309,0	289,80	332610012	118	30	63,5	10,73

Z	de	dp	codice	dm	D1	A	Kg.
13	333,0	313,42	332610013	118	30	63,5	11,83
14	357,0	337,05	332610014	118	30	63,5	13,15
15	380,0	360,73	332610015	118	30	63,5	14,45
16	404,0	384,45	332610016	133	30	65,0	17,43
20	499,0	479,40	332610020	133	30	65,0	23,80
21	523,0	503,17	332610021	133	30	65,0	26,07



PIGNONI PER CATENE TRASPORTO SPROCKETS FOR CONVEYOR CHAINS

**PASSO 100
RULLO 31**

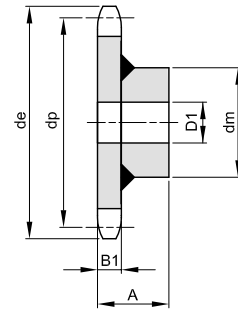
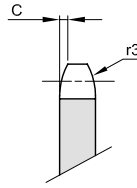

B1	C	r3
13,5	3	50

Materiale: Fe

Z	de	dp	codice	dm	D1	A	Kg.	Z	de	dp	codice	dm	D1	A	Kg.
6	218,0	200,00	332655006	88	25	48,5	4,80								
7	249,0	230,48	332655007	88	25	48,5	5,80								
8	280,0	261,31	332655008	118	30	63,5	9,67								
9	311,0	292,40	332655009	118	30	63,5	10,95								
10	342,0	323,61	332655010	118	30	63,5	12,63								
11	375,0	354,95	332655011	118	30	63,5	14,34								
12	406,0	386,40	332655012	118	30	63,5	16,51								
13	437,0	417,90	332655013	118	30	63,5	18,51								
14	469,0	449,40	332655014	118	30	63,5	20,93								
15	500,0	480,97	332655015	118	30	63,5	23,42								
16	532,0	512,60	332655016	133	30	65,0	27,16								

**PASSO 100
RULLO 40**

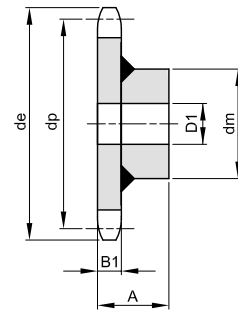
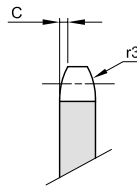

B1	C	r3
20	3	50

Materiale: Fe

Z	de	dp	codice	dm	D1	A	Kg.	Z	de	dp	codice	dm	D1	A	Kg.
6	220,0	200,00	332660006	118	25	70	8,64								
7	251,0	230,48	332660007	118	25	70	10,20								
8	283,0	261,31	332660008	118	30	70	11,97								
9	314,0	292,40	332660009	118	30	70	14,04								
10	345,0	323,61	332660010	118	30	70	16,35								
11	378,0	354,95	332660011	118	30	70	18,82								
12	409,0	386,40	332660012	118	30	70	21,58								
13	441,0	417,90	332660013	118	30	70	25,00								





SCelta DEL PASSO DELLE CATENE A RULLI - DIN 8187 - ISO 606

CHOICE OF ROLLER CHAINS PITCH - DIN 8187 - ISO 606

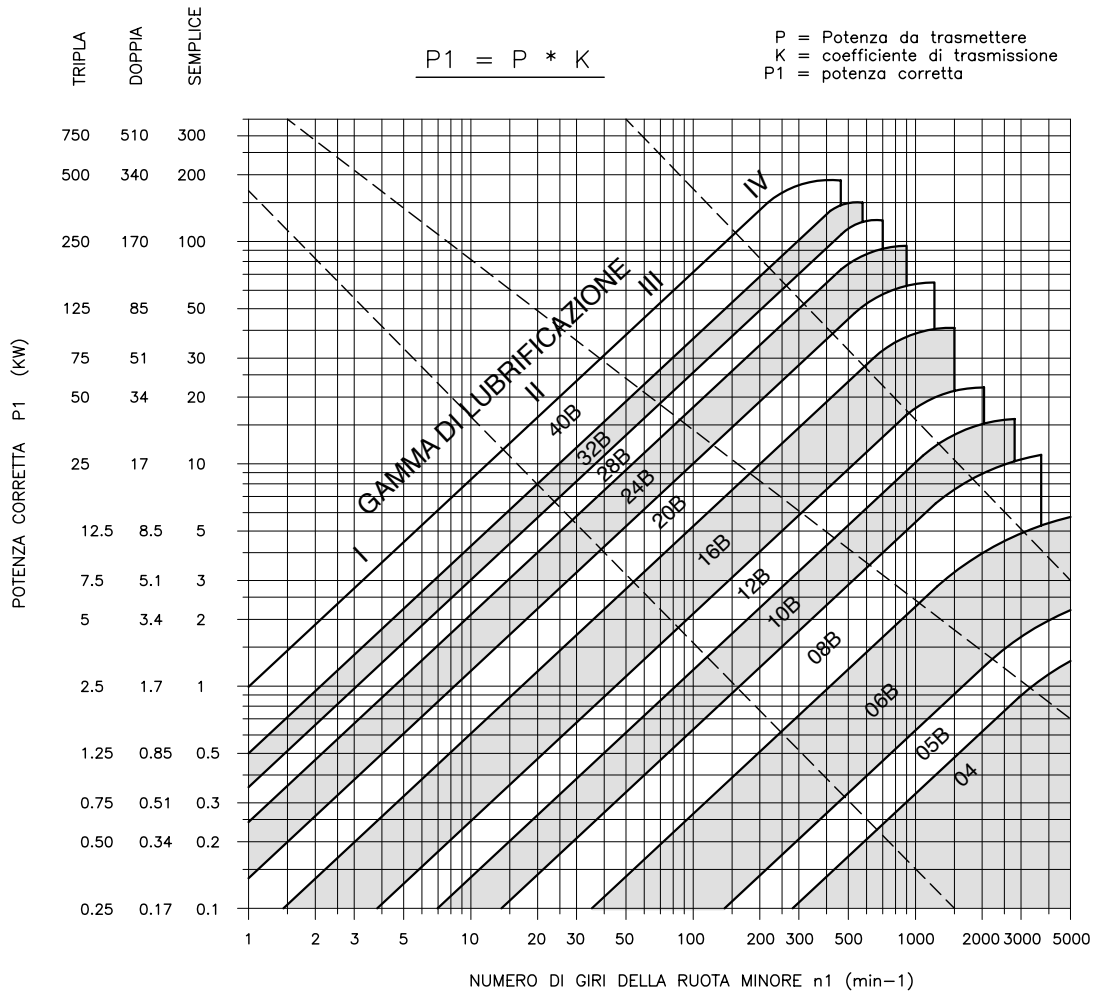

COEFFICIENTE DI TRASMISSIONE "K" PER MOTORI A SCOPPIO AUMENTARE IL FATTORE "K" DI 0,5

modalità d'avanzamento	rapporto di trasmissione $i = n1/n2 = z2/z1$	numero denti della ruota minore z1							
		11	13	15	17	19	21	23	25
Avanzamento senza urti Sollecitazione regolare	1:1	*2,22	*1,85	1,59	1,39	1,22	1,10	0,99	0,91
	2:1	*1,97	1,64	1,41	1,23	1,08	0,97	0,88	0,80
	3:1	1,82	1,52	1,30	1,14	1,00	0,90	0,81	0,74
	5:1	1,68	1,40	1,20	1,05	0,92	0,83	0,75	0,68
Marcia regolare con urti leggeri occasionali, sollecitazione leggermente ondulata	1:1	*2,78	*2,32	1,98	1,74	1,53	1,38	1,24	1,13
	2:1	*2,46	*2,05	1,76	1,55	1,35	1,22	1,10	1,05
	3:1	*2,28	1,90	1,63	1,43	1,25	1,13	1,02	0,93
	5:1	2,10	1,75	1,50	1,31	1,15	1,04	0,93	0,85
Urti leggeri, sollecitazione mediamente ondulata	1:1	*3,33	*2,79	2,38	2,09	1,83	1,65	1,49	1,36
	2:1	*2,95	*2,47	2,11	1,85	1,62	1,46	1,31	1,20
	3:1	*2,73	2,28	1,95	1,71	1,50	1,35	1,22	1,11
	5:1	*2,52	2,10	1,80	1,58	1,38	1,25	1,12	1,03
Urti medi, sollecitazione fortemente ondulata	1:1	*3,89	*3,25	*2,78	2,44	2,14	1,92	1,73	1,58
	2:1	*3,44	*2,87	2,46	2,16	1,89	1,70	1,53	1,40
	3:1	*3,19	*2,66	2,28	2,00	1,75	1,58	1,42	1,30
	5:1	*2,93	*2,45	2,09	1,84	1,66	1,45	1,31	1,19
Urti forti, sollecitazione alternata	1:1	*4,44	*3,71	*3,17	*2,78	2,44	2,20	1,98	1,81
	2:1	*3,93	*3,28	*2,81	2,46	2,16	1,95	1,75	1,60
	3:1	*3,64	*3,04	2,60	2,28	2,00	1,80	1,62	1,48
	5:1	*3,35	*2,80	2,39	2,10	1,84	1,66	1,49	1,36

* condizioni d'avanzamento da evitare



SCelta DEL PASSO DELLE CATENE A RULLI - DIN 8187 - ISO 606

CHOICE OF ROLLER CHAINS PITCH - DIN 8187 - ISO 606



TAVOLA SINOTTICA DEI LUBRIFICANTI

gamma di lubrificazione	velocità della catena m/s	lubrificazione consigliata	potenza trasmissibile			
			lubrificazione corretta	lubrificazione insufficiente senza detriti	lubrificazione insufficiente presenza di detriti	senza lubrificazione
I	fino a ~ 1,5	lubrificazione manuale con pennello - lubrificazione col contagocce (da 4 a 14 gocce al 1')	100%	60%	30%	15%
II	fino a ~ 7	lubrificazione in bagno d'olio all'interno del carter ove è installata la catena lubrificazione col contagocce (~20 gocce d'olio al 1')	100%	30%	15%	-
III	fino a ~ 12	lubrificazione a circolazione forzata tramite disco dosatore installato all'interno del carter - lubrificazione in bagno d'olio	100%	non ammissibile	-	-
IV	oltre 12	lubrificazione a spruzzo mediante pompa di circolazione dell'olio - lubrificazione a circolazione forzata - prevede il raffreddamento	100%	non ammissibile	-	-

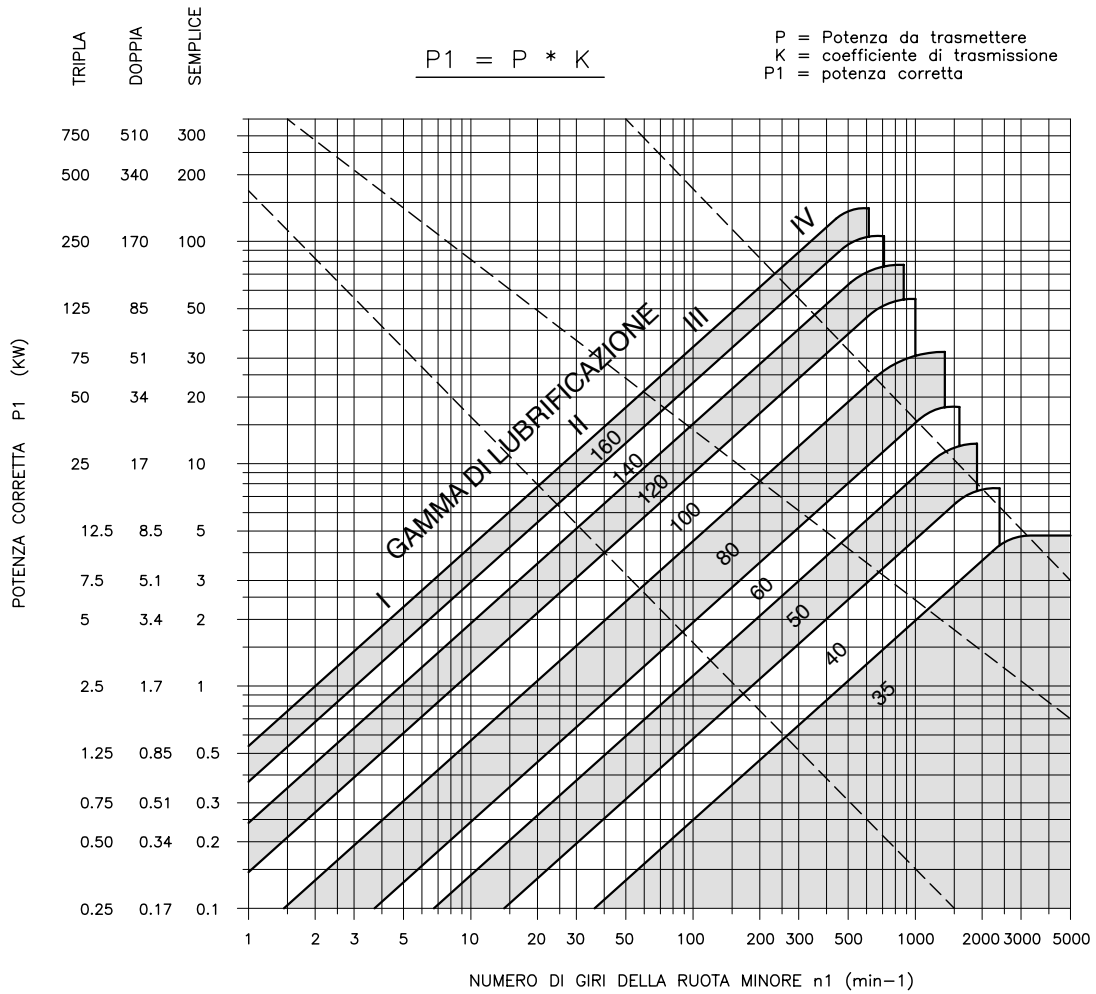

CATENE A RULLI SERIE EUROPEA - DIN 8187 - ISO 606

ROLLER CHAINS EUROPEAN STANDARD - DIN 8187 - ISO 606

Le catene a rulli serie europea possono operare a temperature da -10° a +150°

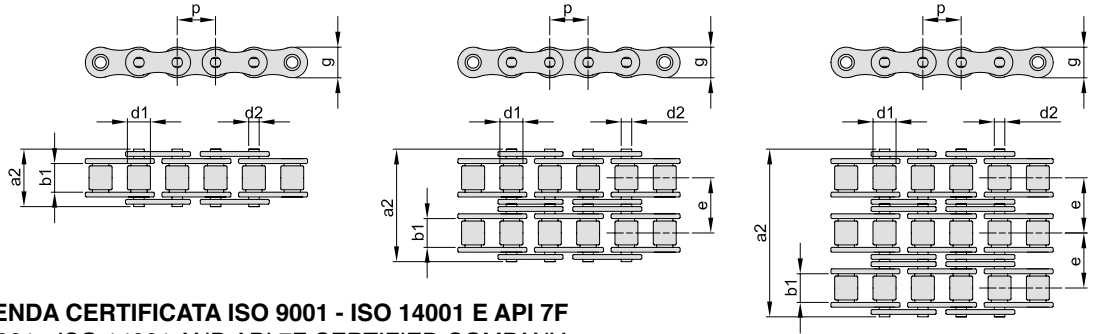

CATENA PRODOTTA DA AZIENDA CERTIFICATA ISO 9001 - ISO 14001 E API 7F
CHAIN PRODUCED BY ISO 9001 - ISO 14001 AND API 7F CERTIFIED COMPANY

CATENA PRESTIRATA / PRE-STRETCHED CHAINS

CONFEZIONI DA 5 MT - ROTOLI DA ▲ 50 MT - ROTOLI DA ■ 100 MT



SEMPLICE

ISO	codice	p		b ₁ mm min.	d ₂ mm	d ₁ mm max.	a ₂ mm max.	g mm max.	Carico di rottura		q kg/m ≈
		mm	inch						minimo KN	medio KN	
04-1	600106000	6	-	2,80	1,85	4,00	7,4	5,00	3,0	3,3	0,12
05B-1	600108000	8	-	3,00	2,31	5,00	8,6	7,11	5,0	5,9	0,18
06B-1	600109000	9,525	3/8"	5,72	3,28	6,35	13,5	8,26	9,0	10,7	0,40
06B-1 ■	600109075	9,525	3/8"	5,72	3,28	6,35	13,5	8,26	9,0	10,7	0,40
08B-1	600112000	12,7	1/2"	7,75	4,45	8,51	17,0	11,81	18,0	21,1	0,68
08B-1 ▲	600112050	12,7	1/2"	7,75	4,45	8,51	17,0	11,81	18,0	21,1	0,68
10B-1	600115000	15,875	5/8"	9,65	5,08	10,16	19,6	14,73	22,4	27,4	0,91
10B-1 ▲	600115050	15,875	5/8"	9,65	5,08	10,16	19,6	14,73	22,4	27,4	0,91
12B-1	600119000	19,05	3/4"	11,68	5,72	12,07	22,7	16,13	29,0	32,3	1,12
12B-1 ▲	600119050	19,05	3/4"	11,68	5,72	12,07	22,7	16,13	29,0	32,3	1,12
16B-1	600125000	25,4	1"	17,02	8,28	15,88	36,1	21,08	60,0	70,6	2,59
20B-1	600131000	31,75	1 1/4"	19,56	10,19	19,05	43,2	26,42	95,0	109,8	3,68
24B-1	600138000	38,1	1 1/2"	25,40	14,63	25,40	53,4	33,40	160,0	179,0	6,85
28B-1	600144000	44,45	1 3/4"	30,99	15,90	27,94	65,1	37,08	200,0	226,0	8,56
32B-1	600150000	50,8	2"	30,99	17,81	29,21	67,4	42,29	250,0	273,0	9,49
40B-1	600163000	63,5	2 1/2"	38,10	22,89	39,37	82,6	52,90	355,0	390,0	15,53

DOPPIA

ISO	codice	p		b ₁ mm min.	d ₂ mm	d ₁ mm max.	a ₂ mm max.	g mm max.	e mm	Carico di rottura		q kg/m ≈
		mm	inch							minimo KN	medio KN	
05B-2	600108200	8	-	3,00	2,31	5,00	14,3	7,11	5,64	7,8	8,5	0,32
06B-2	600109200	9,525	3/8"	5,72	3,28	6,35	23,8	8,26	10,24	16,9	19,2	0,76
08B-2	600112200	12,7	1/2"	7,75	4,45	8,51	31,0	11,81	13,92	32,0	38,0	1,31
10B-2	600115200	15,875	5/8"	9,65	5,08	10,16	36,2	14,73	16,59	44,5	57,3	1,79
12B-2	600119200	19,05	3/4"	11,68	5,72	12,07	42,2	16,13	19,46	57,8	65,7	2,22
16B-2	600125200	25,4	1"	17,02	8,28	15,88	68,0	21,08	31,88	113,7	137,5	5,03
20B-2	600131200	31,75	1 1/4"	19,56	10,19	19,05	79,7	26,42	36,45	170,0	210,0	7,33
24B-2	600138200	38,1	1 1/2"	25,40	14,63	25,40	101,8	33,40	48,36	280,0	322,5	13,50
28B-2	600144200	44,45	1 3/4"	30,99	15,90	27,94	124,7	37,08	59,56	360,0	412,6	16,96
32B-2	600150200	50,8	2"	30,99	17,81	29,21	126,0	42,99	58,55	450,0	510,8	18,74
40B-2	600163200	63,5	2 1/2"	38,10	22,89	39,37	154,0	52,90	72,29	630,0	708,1	30,72

TRIPLA

ISO	codice	p		b ₁ mm min.	d ₂ mm	d ₁ mm max.	a ₂ mm max.	g mm max.	e mm	Carico di rottura		q kg/m ≈
		mm	inch							minimo KN	medio KN	
06B-3	600109300	9,525	3/8"	5,72	3,28	6,35	34,0	8,26	10,24	24,9	27,7	1,12
08B-3	600112300	12,7	1/2"	7,75	4,45	8,51	44,9	11,81	13,92	47,5	56,0	1,94
10B-3	600115300	15,875	5/8"	9,65	5,08	10,16	52,8	14,73	16,59	66,7	83,3	2,68
12B-3	600119300	19,05	3/4"	11,68	5,72	12,07	61,7	16,13	19,46	86,7	101,5	3,32
16B-3	600125300	25,4	1"	17,02	8,28	15,88	99,9	21,08	31,88	160,0	202,8	7,65
20B-3	600131300	31,75	1 1/4"	19,56	10,19	19,05	116,1	26,42	36,45	250,0	306,5	10,96
24B-3	600138300	38,1	1 1/2"	25,40	14,63	25,40	150,2	33,40	48,36	425,0	490,6	20,20
28B-3	600144300	44,45	1 3/4"	30,99	15,90	27,94	184,3	37,08	59,56	530,0	625,9	25,38
32B-3	600150300	50,8	2"	30,99	17,81	29,21	184,5	42,99	58,55	670,0	775,0	28,04



CATENE A RULLI SERIE AMERICANA - DIN 8188 - ANSI B29.1 "ASA" ROLLER CHAINS AMERICAN STANDARD - DIN 8188 - ANSI B29.1 "ASA"

Le catene a rulli serie americana possono operare a temperature da -10° a +150°

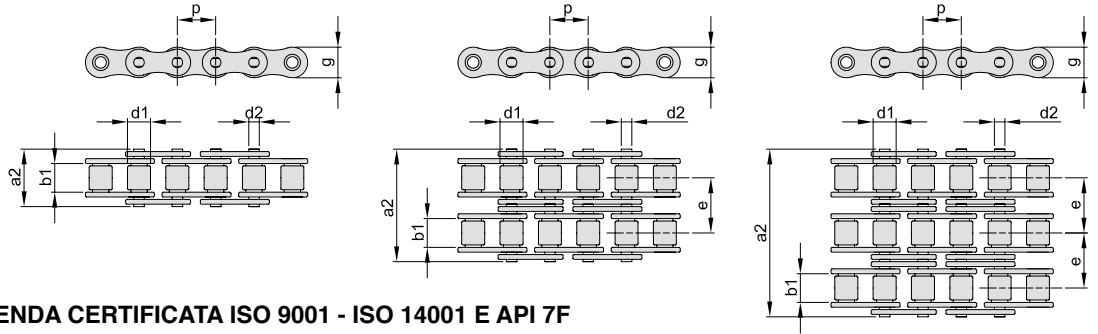

CATENA PRODOTTA DA AZIENDA CERTIFICATA ISO 9001 - ISO 14001 E API 7F
CHAIN PRODUCED BY ISO 9001 - ISO 14001 AND API 7F CERTIFIED COMPANY

CATENA PRESTIRATA / PRE-STRETCHED CHAINS

CONFEZIONI DA 3 MT



SEMPLICE

ANSI	codice	p		b ₁ mm min.	d ₂ mm	d ₁ mm max.	a ₂ mm max.	g mm max.	Carico di rottura		q kg/m ≈
		mm	inch						minimo KN	medio KN	
35-1	620035000	9,525	3/8"	4,77	3,58	5,08	13,2	9,05	7,8	10,1	0,34
40-1	620040000	12,7	1/2"	7,95	3,96	7,92	17,8	12,07	14,1	18,8	0,63
50-1	620050000	15,875	5/8"	9,53	5,08	10,16	21,8	15,09	22,2	30,4	1,04
60-1	620060000	19,05	3/4"	12,70	5,94	11,91	26,9	18,08	31,8	41,7	1,52
80-1	620080000	25,4	1"	15,88	7,92	15,88	33,5	24,13	56,7	72,6	2,58
100-1	620100000	31,75	1 1/4"	19,05	9,53	19,05	41,1	30,18	88,5	110,4	3,85
120-1	620120000	38,1	1 1/2"	25,40	11,10	22,23	50,8	36,20	127,0	144,6	5,61
140-1	620140000	44,45	1 3/4"	25,40	12,70	25,40	54,9	42,24	172,4	190,8	7,24
160-1	620160000	50,8	2"	31,75	14,27	28,58	65,5	48,26	226,8	253,4	9,91
60-1H	621060000	19,05	3/4"	12,70	5,94	11,91	31,2	18,08	31,2	42,1	1,81
80-1H	621080000	25,4	1"	15,88	7,92	15,88	38,0	24,13	55,6	72,6	3,00
100-1H	621100000	31,75	1 1/4"	19,05	9,53	19,05	45,4	30,18	86,8	110,4	4,38

DOPPIA

ANSI	codice	p		b ₁ mm min.	d ₂ mm	d ₁ mm max.	a ₂ mm max.	g mm max.	e mm	Carico di rottura		q kg/m ≈
		mm	inch							minimo KN	medio KN	
35-2	620035200	9,525	3/8"	4,77	3,58	5,08	21,6	9,05	10,13	15,6	20,3	0,67
40-2	620040200	12,7	1/2"	7,95	3,96	7,92	32,3	12,07	14,38	28,2	37,7	1,26
50-2	620050200	15,875	5/8"	9,53	5,08	10,16	39,9	15,09	18,11	44,4	60,8	2,05
60-2	620060200	19,05	3/4"	12,70	5,94	11,91	49,8	18,08	22,78	63,3	83,4	3,01
80-2	620080200	25,4	1"	15,88	7,92	15,88	62,7	24,13	29,29	113,4	145,1	5,13
100-2	620100200	31,75	1 1/4"	19,05	9,53	19,05	77,0	30,18	35,76	177,0	220,8	7,64
120-2	620120200	38,1	1 1/2"	25,40	11,10	22,23	96,3	36,20	45,44	254,0	289,3	11,13
140-2	620140200	44,45	1 3/4"	25,40	12,70	25,40	103,6	42,24	48,87	344,8	381,6	14,37
160-2	620160200	50,8	2"	31,75	14,27	28,58	124,2	48,26	58,55	453,6	506,7	19,68

TRIPLA

ANSI	codice	p		b ₁ mm min.	d ₂ mm	d ₁ mm max.	a ₂ mm max.	g mm max.	e mm	Carico di rottura		q kg/m ≈
		mm	inch							minimo KN	medio KN	
*35-3	620035300	9,525	3/8"	4,77	3,58	5,08	31,8	9,05	10,13	23,4	30,5	0,99
*40-3	620040300	12,7	1/2"	7,95	3,96	7,92	46,7	12,07	14,38	42,3	56,6	1,98
*50-3	620050300	15,875	5/8"	9,53	5,08	10,16	57,9	15,09	18,11	66,6	82,5	3,06
*60-3	620060300	19,05	3/4"	12,70	5,94	11,91	72,6	18,08	22,78	95,4	120,1	4,50
*80-3	620080300	25,4	1"	15,88	7,92	15,88	91,7	24,13	29,29	170,1	201,9	7,67
*100-3	620100300	31,75	1 1/4"	19,05	9,53	19,05	113,0	30,18	35,76	265,5	313,9	11,43
*120-3	620120300	38,1	1 1/2"	25,40	11,10	22,23	141,7	36,20	45,44	381,0	433,9	16,67
*140-3	620140300	44,45	1 3/4"	25,40	12,70	25,40	152,4	42,24	48,87	517,2	583,4	21,51
*160-3	620160300	50,8	2"	31,75	14,27	28,58	182,9	48,26	58,55	680,4	760,1	29,45

* Costruite a richiesta / Manufactured on request



CATENE A RULLI CON PIASTRE A PROFILO DIRITTO - DIN 8187 - ISO 606

ROLLER CHAINS WITH STRAIGHT PLATES - DIN 8187 - ISO 606

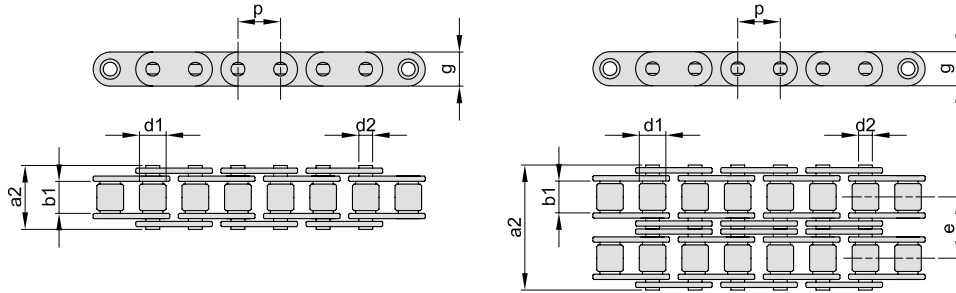

CATENA PRODOTTA DA AZIENDA CERTIFICATA ISO 9001 - ISO 14001 E API 7F
CHAIN PRODUCED BY ISO 9001 - ISO 14001 AND API 7F CERTIFIED COMPANY

CATENA PRESTIRATA / PRE-STRETCHED CHAINS



CONFEZIONI DA 5 MT

SEMPLICE

ISO	codice	p		b ₁ mm min.	d ₂ mm	d ₁ mm max.	a ₂ mm max.	g mm max.	Carico di rottura		q kg/m ≈
		mm	inch						minimo KN	medio KN	
08B-1	601112000	12,7	1/2"	7,75	4,45	8,51	17,0	11,8	18,0	21,1	0,75
10B-1	601115000	15,875	5/8"	9,65	5,08	10,16	19,6	14,7	22,4	27,4	0,98
12B-1	601119000	19,05	3/4"	11,68	5,72	12,07	22,7	16,1	29,0	32,3	1,24
16B-1	601125000	25,4	1"	17,02	8,28	15,88	36,1	20,6	60,0	70,6	3,30
20B-1	601131000	31,75	1" 1/4	19,56	10,19	19,05	43,2	26,4	95,0	109,8	3,91

DOPPIA

ISO	codice	p		b ₁ mm min.	d ₂ mm	d ₁ mm max.	a ₂ mm max.	g mm max.	e mm	Carico di rottura		q kg/m ≈
		mm	inch							minimo KN	medio KN	
10B-2	601115200	15,875	5/8"	9,65	5,08	10,16	36,2	14,7	16,59	44,5	57,3	1,97
12B-2	601119200	19,05	3/4"	11,68	5,72	12,07	42,2	16,1	19,46	57,8	65,7	2,27
16B-2	601125200	25,4	1"	17,02	8,28	15,88	68,0	20,6	31,88	113,7	137,5	5,78
20B-2	601131200	31,75	1" 1/4	19,56	10,19	19,05	79,7	26,4	35,45	170,0	210,0	7,72



CATENE A PERNI FORATI - DIN 8187 - ISO 606

HOLLOW PINS CHAINS - DIN 8187 - ISO 606

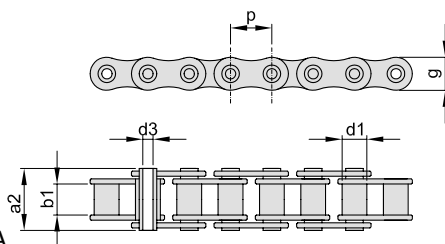

TIPO A - A BUSSOLA

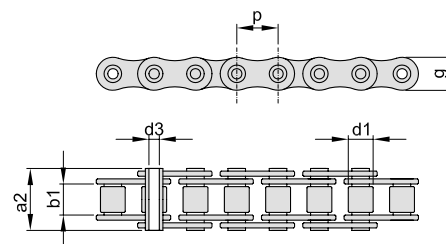

TIPO B - A RULLI

CATENA PRODOTTA DA AZIENDA CERTIFICATA ISO 9001 - ISO 14001 E API 7F
CHAIN PRODUCED BY ISO 9001 - ISO 14001 AND API 7F CERTIFIED COMPANY

CATENA PRESTIRATA / PRE-STRETCHED CHAINS



CONFEZIONI DA 5 MT

ISO	codice	p		b ₁ mm min.	d ₃ mm	d ₁ mm max.	a ₂ mm max.	g mm max.	Carico di rottura		q kg/m ≈	TIPO
		mm	inch						minimo KN	medio KN		
08B-1	601512000	12,7	1/2"	7,75	4,50	8,51	17,0	11,6	9,3	12,8	0,58	A
10B-1	601515000	15,875	5/8"	9,65	5,18	10,16	19,6	14,7	12,7	16,4	0,73	A
12B-1	601519000	19,05	3/4"	11,68	5,85	12,07	22,7	15,9	12,7	17,5	1,10	A
08B-1	601612000	12,7	1/2"	7,75	4,50	8,51	17,0	11,6	10,8	17,4	0,58	B
10B-1	601615000	15,875	5/8"	9,65	5,18	10,16	19,6	14,5	14,7	19,7	0,77	B
12B-1	601619000	19,05	3/4"	11,68	5,85	12,07	22,7	15,9	16,7	23,3	0,98	B
16B-1	601625000	25,4	1"	17,02	8,33	15,88	36,1	20,5	32,7	41,0	2,21	B



CATENE A RULLI AUTOLUBRIFICANTI - DIN 8187 - ISO 606

SINTERED BUSH CHAINS - DIN 8187 - ISO 606

Costruita con speciali bussole in acciaio sinterizzato. Indicata per applicazioni con scarsa lubrificazione come nelle industrie alimentari, chimiche, farmaceutiche, elettroniche ecc.

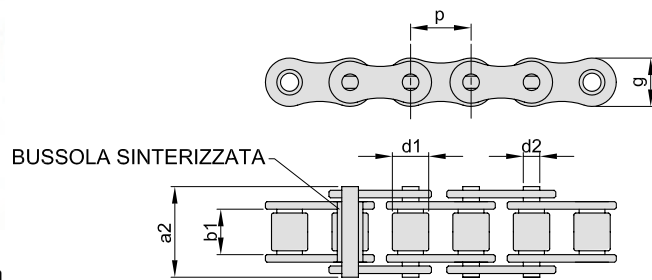
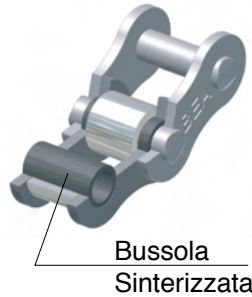

CATENA PRODOTTA DA AZIENDA CERTIFICATA ISO 9001 - ISO 14001 E API 7F
CHAIN PRODUCED BY ISO 9001 - ISO 14001 AND API 7F CERTIFIED COMPANY

CATENA PRESTIRATA / PRE-STRETCHED CHAINS

CONFEZIONI DA 5 MT



ISO	codice	p		b ₁ mm min.	d ₂ mm	d ₁ mm max.	a ₂ mm max.	g mm max.	Carico di rottura		q kg/m ≈
		mm	inch						minimo KN	medio KN	
08B-1	643112000	12,7	1/2"	7,75	4,45	8,51	17,0	12,40	18,0	19,6	0,70
10B-1	643115000	15,875	5/8"	9,65	5,08	10,16	19,6	14,70	22,4	25,7	0,88
12B-1	643119000	19,05	3/4"	11,68	5,72	12,07	22,7	16,10	29,0	30,4	1,10



CATENE A RULLI "O-RING" - DIN 8187 - ISO 606

"O-RING" CHAINS - DIN 8187 - ISO 606

Costruita con anelli di tenuta lubrificati che impediscono l'entrata di detriti e offrono una maggiore resistenza all'usura. Le catene a rulli O-RING possono operare a temperature da -10° a +60°

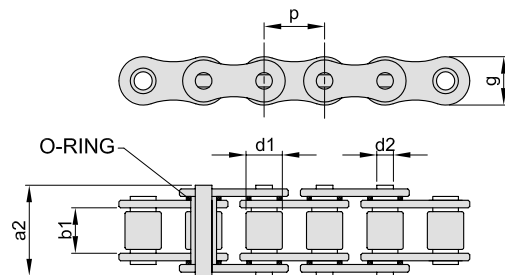
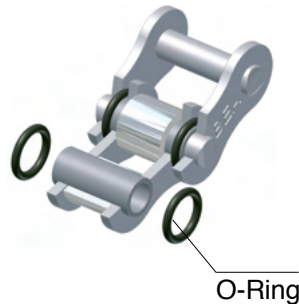

CATENA PRODOTTA DA AZIENDA CERTIFICATA ISO 9001 - ISO 14001 E API 7F
CHAIN PRODUCED BY ISO 9001 - ISO 14001 AND API 7F CERTIFIED COMPANY

CATENA PRESTIRATA / PRE-STRETCHED CHAINS

CONFEZIONE DA 5 MT



ISO	codice	p		b ₁ mm min.	d ₂ mm	d ₁ mm max.	a ₂ mm max.	g mm max.	Carico di rottura		q kg/m ≈
		mm	inch						minimo KN	medio KN	
08B-1	644112000	12,7	1/2"	7,75	4,45	8,51	19,0	11,56	18,1	18,4	0,70
10B-1	644115000	15,875	5/8"	9,65	5,06	10,16	21,9	14,48	22,2	23,8	0,92



CATENE A RULLI CON ATTACCHI ANGOLARI - DIN 8187 - ISO 606

ROLLER CHAINS WITH ANGLE ATTACHMENTS - DIN 8187 - ISO 606

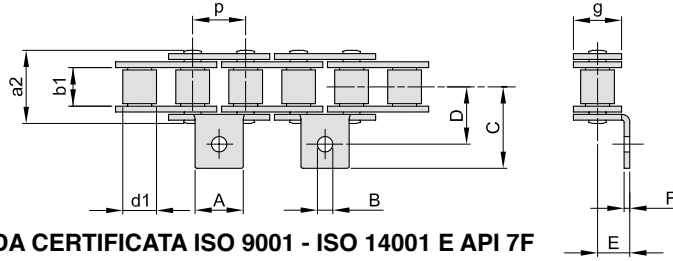

A1/02

CATENA PRODOTTA DA AZIENDA CERTIFICATA ISO 9001 - ISO 14001 E API 7F
CHAIN PRODUCED BY ISO 9001 - ISO 14001 AND API 7F CERTIFIED COMPANY

CATENA PRESTIRATA / PRE-STRETCHED CHAINS

CONFEZIONE DA 5 MT



ISO	codice	p		b1 mm min.	d1 mm max.	a2 mm max.	g mm max.	A mm	B mm	C mm max.	D mm	E mm	F mm	Carico di rottura		q kg/m ≈
		mm	inch											minimo KN	medio KN	
06B-1	604109112	9,525	3/8"	5,72	6,35	13,5	8,26	8,0	3,5	13,5	9,5	6,5	1,03	9,0	10,7	0,46
08B-1	604112112	12,7	1/2"	7,75	8,51	17,0	11,81	9,5	4,3	18,6	14,1	8,4	1,40	18,0	21,1	0,77
10B-1	604115112	15,875	5/8"	9,65	10,16	19,6	14,73	14,1	5,2	23,8	15,9	10,4	1,63	22,4	27,4	1,04
12B-1	604119112	19,05	3/4"	11,68	12,07	22,7	16,13	15,8	5,6	25,8	17,5	12,0	1,80	29,0	32,3	1,35
16B-1	604125112	25,4	1"	17,02	15,88	36,1	21,08	19,0	6,8	37,4	25,4	15,9	3,00	60,0	70,6	2,83

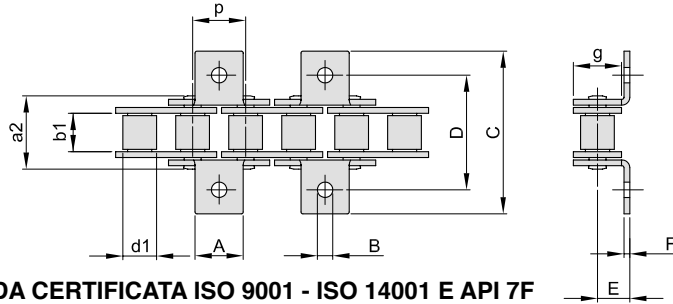

K1/02

CATENA PRODOTTA DA AZIENDA CERTIFICATA ISO 9001 - ISO 14001 E API 7F
CHAIN PRODUCED BY ISO 9001 - ISO 14001 AND API 7F CERTIFIED COMPANY

CATENA PRESTIRATA / PRE-STRETCHED CHAINS

CONFEZIONE DA 5 MT



ISO	codice	p		b1 mm min.	d1 mm max.	a2 mm max.	g mm max.	A mm	B mm	C mm max.	D mm	E mm	F mm	Carico di rottura		q kg/m ≈
		mm	inch											minimo KN	medio KN	
06B-1	604109212	9,525	3/8"	5,72	6,35	13,5	8,26	8,0	3,5	27,0	19,0	6,5	1,03	9,0	10,7	0,51
08B-1	604112212	12,7	1/2"	7,75	8,51	17,0	11,81	9,5	4,3	37,2	28,2	8,4	1,40	18,0	21,1	0,85
10B-1	604115212	15,875	5/8"	9,65	10,16	19,6	14,73	14,1	5,2	47,6	31,8	10,4	1,63	22,4	27,4	1,13
12B-1	604119212	19,05	3/4"	11,68	12,07	22,7	16,13	15,8	5,6	51,6	35,0	12,0	1,80	29,0	32,3	1,45
16B-1	604125212	25,4	1"	17,02	15,88	36,1	21,08	19,0	6,8	74,8	50,8	15,9	3,00	60,0	70,6	3,48

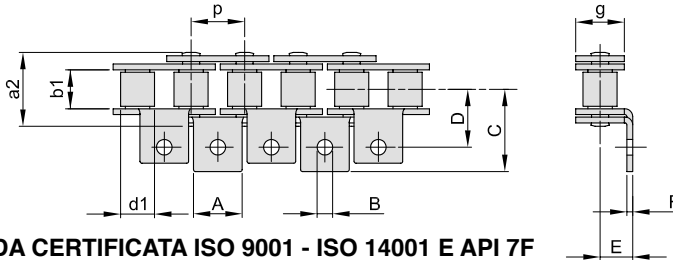

A1/01

CATENA PRODOTTA DA AZIENDA CERTIFICATA ISO 9001 - ISO 14001 E API 7F
CHAIN PRODUCED BY ISO 9001 - ISO 14001 AND API 7F CERTIFIED COMPANY

CATENA PRESTIRATA / PRE-STRETCHED CHAINS

CONFEZIONE DA 5 MT



ISO	codice	p		b1 mm min.	d1 mm max.	a2 mm max.	g mm max.	A mm	B mm	C mm max.	D mm	E mm	F mm	Carico di rottura		q kg/m ≈
		mm	inch											minimo KN	medio KN	
06B-1	604109111	9,525	3/8"	5,72	6,35	13,5	8,26	8,0	3,5	13,5	9,5	6,5	1,03	9,0	10,7	0,51
08B-1	604112111	12,7	1/2"	7,75	8,51	17,0	11,81	9,5	4,3	18,6	14,1	8,4	1,40	18,0	21,1	0,85
10B-1	604115111	15,875	5/8"	9,65	10,16	19,6	14,73	14,1	5,2	23,8	15,9	10,4	1,63	22,4	27,4	1,13
12B-1	604119111	19,05	3/4"	11,68	12,07	22,7	16,13	15,8	5,6	25,8	17,5	12,0	1,80	29,0	32,3	1,45
16B-1	604125111	25,4	1"	17,02	15,88	36,1	21,08	19,0	6,8	37,4	25,4	15,9	3,00	60,0	70,6	3,48



CATENE A RULLI CON ATTACCHI ANGOLARI - DIN 8187 - ISO 606

ROLLER CHAINS WITH ANGLE ATTACHMENTS - DIN 8187 - ISO 606

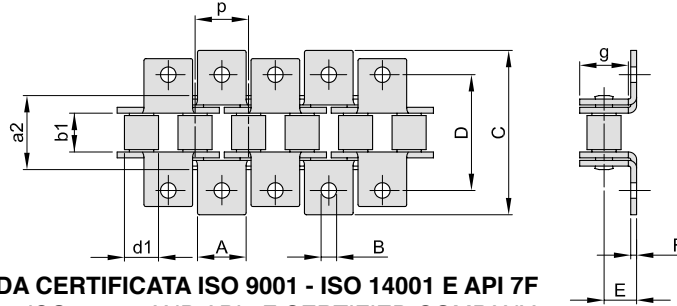

K1/01

CATENA PRODotta DA AZIENDA CERTIFICATA ISO 9001 - ISO 14001 E API 7F
CHAIN PRODUCED BY ISO 9001 - ISO 14001 AND API 7F CERTIFIED COMPANY
CATENA PRESTIRATA / PRE-STRETCHED CHAINS

CONFEZIONE DA 5 MT



ISO	codice	p		b ₁ mm min.	d ₁ mm max.	a ₂ mm max.	g mm max.	A mm	B mm	C mm max.	D mm	E mm	F mm	Carico di rottura		q kg/m ≈
		mm	inch											minimo KN	medio KN	
06B-1	604109211	9,525	3/8"	5,72	6,35	13,5	8,26	8,0	3,5	27,0	19,0	6,5	1,03	9,0	10,7	0,61
08B-1	604112211	12,7	1/2"	7,75	8,51	17,0	11,81	9,5	4,3	37,2	28,2	8,4	1,40	18,0	21,1	1,01
10B-1	604115211	15,875	5/8"	9,65	10,16	19,6	14,73	14,1	5,2	47,6	31,8	10,4	1,63	22,4	27,4	1,32
12B-1	604119211	19,05	3/4"	11,68	12,07	22,7	16,13	15,8	5,6	51,6	35,0	12,0	1,80	29,0	32,3	1,66
16B-1	604125211	25,4	1"	17,02	15,88	36,1	21,08	19,0	6,8	74,8	50,8	15,9	3,00	60,0	70,6	4,27

A2/02

CATENA PRODotta DA AZIENDA CERTIFICATA ISO 9001 - ISO 14001 E API 7F
CHAIN PRODUCED BY ISO 9001 - ISO 14001 AND API 7F CERTIFIED COMPANY
CATENA PRESTIRATA / PRE-STRETCHED CHAINS

CONFEZIONE DA 5 MT



ISO	codice	p		b ₁ mm min.	d ₁ mm max.	a ₂ mm max.	g mm max.	A mm	B mm	C mm max.	D mm	E mm	F mm	Carico di rottura		q kg/m ≈
		mm	inch											minimo KN	medio KN	
06B-1	604109122	9,525	3/8"	5,72	6,35	13,5	8,26	17,6	3,5	13,5	9,5	6,5	1,03	9,0	10,7	0,51
08B-1	604112122	12,7	1/2"	7,75	8,51	17,0	11,81	23,2	4,3	18,6	14,1	8,4	1,40	18,0	21,1	0,85
10B-1	604115122	15,875	5/8"	9,65	10,16	19,6	14,73	29,3	5,2	23,8	15,9	10,4	1,63	22,4	27,4	1,13
12B-1	604119122	19,05	3/4"	11,68	12,07	22,7	16,13	33,0	5,6	30,5	17,5	12,0	1,80	29,0	32,3	1,45
16B-1	604125122	25,4	1"	17,02	15,88	36,1	21,08	46,0	6,8	39,1	25,4	15,9	3,00	60,0	70,6	3,19

K2/02

CATENA PRODotta DA AZIENDA CERTIFICATA ISO 9001 - ISO 14001 E API 7F
CHAIN PRODUCED BY ISO 9001 - ISO 14001 AND API 7F CERTIFIED COMPANY
CATENA PRESTIRATA / PRE-STRETCHED CHAINS

CONFEZIONE DA 5 MT



ISO	codice	p		b ₁ mm min.	d ₁ mm max.	a ₂ mm max.	g mm max.	A mm	B mm	C mm max.	D mm	E mm	F mm	Carico di rottura		q kg/m ≈
		mm	inch											minimo KN	medio KN	
06B-1	604109222	9,525	3/8"	5,72	6,35	13,5	8,26	17,6	3,5	27,0	19	6,5	1,03	9,0	10,7	0,61
08B-1	604112222	12,7	1/2"	7,75	8,51	17,0	11,81	23,2	4,3	37,2	28,2	8,4	1,40	18,0	21,1	1,01
10B-1	604115222	15,875	5/8"	9,65	10,16	19,6	14,73	29,3	5,2	47,6	31,8	10,4	1,63	22,4	27,4	1,32
12B-1	604119222	19,05	3/4"	11,68	12,07	22,7	16,13	33,0	5,6	61,0	35,0	12,0	1,80	29,0	32,3	1,66
16B-1	604125222	25,4	1"	17,02	15,88	36,1	21,08	46,0	6,8	78,2	50,8	15,9	3,00	60,0	70,6	3,78



CATENE A RULLI CON ATTACCHI VERTICALI - DIN 8187 - ISO 606

ROLLER CHAINS WITH VERTICAL ATTACHMENTS - DIN 8187 - ISO 606

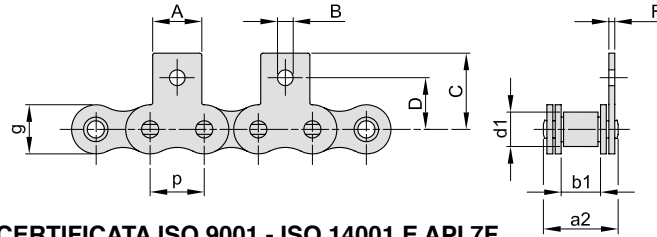

M1/02

CATENA PRODOTTA DA AZIENDA CERTIFICATA ISO 9001 - ISO 14001 E API 7F
CHAIN PRODUCED BY ISO 9001 - ISO 14001 AND API 7F CERTIFIED COMPANY

CATENA PRESTIRATA / PRE-STRETCHED CHAINS

CONFEZIONE DA 5 MT



ISO	codice	p		b ₁ mm min.	d ₁ mm max.	a ₂ mm max.	g mm max.	A mm	B mm	C mm max.	D mm	F mm	Carico di rottura		q kg/m ≈
		mm	inch										minimo KN	medio KN	
06B-1	603109112	9,525	3/8"	5,72	6,35	13,5	8,26	8,0	3,5	13,5	9,5	1,03	9,0	10,7	0,46
08B-1	603112112	12,7	1/2"	7,75	8,51	17,0	11,81	9,5	4,3	18,4	14,1	1,40	18,0	21,1	0,77
10B-1	603115112	15,875	5/8"	9,65	10,16	19,6	14,73	14,1	5,2	24,7	15,9	1,63	22,4	27,4	1,04
12B-1	603119112	19,05	3/4"	11,68	12,07	22,7	16,13	15,8	5,6	26,6	17,9	1,80	29,0	32,3	1,35
16B-1	603125112	25,4	1"	17,02	15,88	36,1	21,08	19,0	6,8	35,0	26,0	3,00	60,0	70,6	2,83

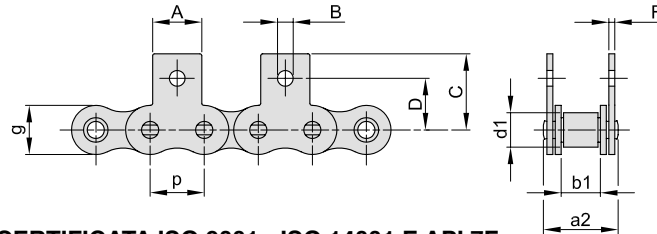

MK1/02

CATENA PRODOTTA DA AZIENDA CERTIFICATA ISO 9001 - ISO 14001 E API 7F
CHAIN PRODUCED BY ISO 9001 - ISO 14001 AND API 7F CERTIFIED COMPANY

CATENA PRESTIRATA / PRE-STRETCHED CHAINS

CONFEZIONE DA 5 MT



ISO	codice	p		b ₁ mm min.	d ₁ mm max.	a ₂ mm max.	g mm max.	A mm	B mm	C mm max.	D mm	F mm	Carico di rottura		q kg/m ≈
		mm	inch										minimo KN	medio KN	
06B-1	603109212	9,525	3/8"	5,72	6,35	13,5	8,26	8,0	3,5	13,5	9,5	1,03	9,0	10,7	0,51
08B-1	603112212	12,7	1/2"	7,75	8,51	17,0	11,81	9,5	4,3	18,4	14,1	1,40	18,0	21,1	0,85
10B-1	603115212	15,875	5/8"	9,65	10,16	19,6	14,73	14,1	5,2	24,7	15,9	1,63	22,4	27,4	1,13
12B-1	603119212	19,05	3/4"	11,68	12,07	22,7	16,13	15,8	5,6	26,6	17,9	1,80	29,0	32,3	1,45
16B-1	603125212	25,4	1"	17,02	15,88	36,1	21,08	19,0	6,8	35,0	26,0	3,00	60,0	70,6	3,48

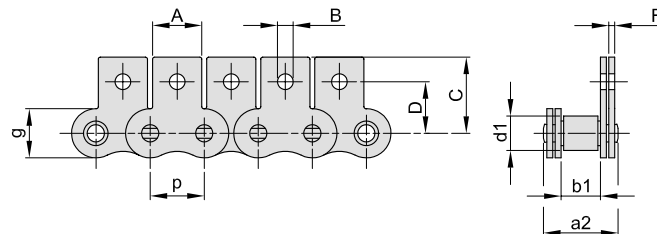

M1/01

CATENA PRODOTTA DA AZIENDA CERTIFICATA ISO 9001 - ISO 14001 E API 7F
CHAIN PRODUCED BY ISO 9001 - ISO 14001 AND API 7F CERTIFIED COMPANY

CATENA PRESTIRATA / PRE-STRETCHED CHAINS

CONFEZIONE DA 5 MT



ISO	codice	p		b ₁ mm min.	d ₁ mm max.	a ₂ mm max.	g mm max.	A mm	B mm	C mm max.	D mm	F mm	Carico di rottura		q kg/m ≈
		mm	inch										minimo KN	medio KN	
06B-1	603109111	9,525	3/8"	5,72	6,35	13,5	8,26	8,0	3,5	13,5	9,5	1,03	9,0	10,7	0,51
08B-1	603112111	12,7	1/2"	7,75	8,51	17,0	11,81	9,5	4,3	18,4	14,1	1,40	18,0	21,1	0,85
10B-1	603115111	15,875	5/8"	9,65	10,16	19,6	14,73	14,1	5,2	24,7	15,9	1,63	22,4	27,4	1,13
12B-1	603119111	19,05	3/4"	11,68	12,07	22,7	16,13	15,8	5,6	26,6	17,9	1,80	29,0	32,3	1,45
16B-1	603125111	25,4	1"	17,02	15,88	36,1	21,08	19,0	6,8	35,0	26,0	3,00	60,0	70,6	3,48



CATENE A RULLI CON ATTACCHI VERTICALI - DIN 8187 - ISO 606

ROLLER CHAINS WITH VERTICAL ATTACHMENTS - DIN 8187 - ISO 606

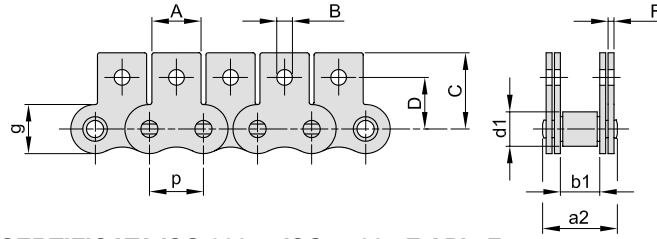

MK1/01

CATENA PRODOTTA DA AZIENDA CERTIFICATA ISO 9001 - ISO 14001 E API 7F
CHAIN PRODUCED BY ISO 9001 - ISO 14001 AND API 7F CERTIFIED COMPANY

CATENA PRESTIRATA / PRE-STRETCHED CHAINS

CONFEZIONE DA 5 MT



ISO	codice	p		b ₁ mm min.	d ₁ mm max.	a ₂ mm max.	g mm max.	A mm	B mm	C mm max.	D mm	F mm	Carico di rottura		q kg/m ≈
		mm	inch										minimo KN	medio KN	
06B-1	603109211	9,525	3/8"	5,72	6,35	13,5	8,26	8,0	3,5	13,5	9,5	1,03	9,0	10,7	0,61
08B-1	603112211	12,7	1/2"	7,75	8,51	17,0	11,81	9,5	4,3	18,4	14,1	1,40	18,0	21,1	1,01
10B-1	603115211	15,875	5/8"	9,65	10,16	19,6	14,73	14,1	5,2	24,7	15,9	1,63	22,4	27,4	1,32
12B-1	603119211	19,05	3/4"	11,68	12,07	22,7	16,13	15,8	5,6	26,6	17,9	1,80	29,0	32,3	1,66
16B-1	603125211	25,4	1"	17,02	15,88	36,1	21,08	19,0	6,8	35,0	26,0	3,00	60,0	70,6	4,27

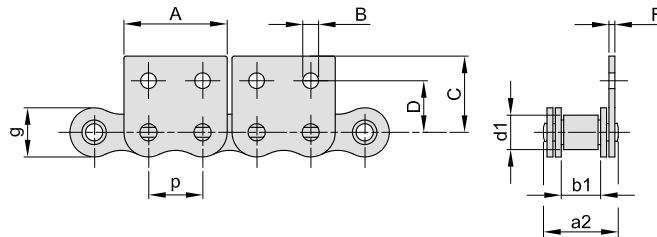

M2/02

CATENA PRODOTTA DA AZIENDA CERTIFICATA ISO 9001 - ISO 14001 E API 7F
CHAIN PRODUCED BY ISO 9001 - ISO 14001 AND API 7F CERTIFIED COMPANY

CATENA PRESTIRATA / PRE-STRETCHED CHAINS

CONFEZIONE DA 5 MT



ISO	codice	p		b ₁ mm min.	d ₁ mm max.	a ₂ mm max.	g mm max.	A mm	B mm	C mm max.	D mm	F mm	Carico di rottura		q kg/m ≈
		mm	inch										minimo KN	medio KN	
06B-1	603109122	9,525	3/8"	5,72	6,35	13,5	8,26	17,6	3,2	13,5	9,5	1,03	9,0	10,7	0,51
08B-1	603112122	12,7	1/2"	7,75	8,51	17,0	11,81	23,2	4,3	18,4	14,1	1,40	18,0	21,1	0,85
10B-1	603115122	15,875	5/8"	9,65	10,16	19,6	14,73	29,3	5,2	24,7	15,9	1,63	22,4	27,4	1,13
12B-1	603119122	19,05	3/4"	11,68	12,07	22,7	16,13	33,0	5,6	31,3	17,9	1,80	29,0	32,3	1,45
16B-1	603125122	25,4	1"	17,02	15,88	36,1	21,08	45,9	6,8	36,6	26,0	3,00	60,0	70,6	3,48

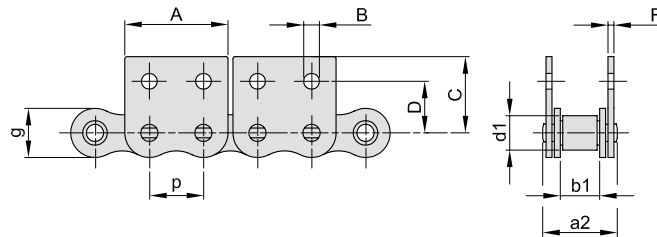

MK2/02

CATENA PRODOTTA DA AZIENDA CERTIFICATA ISO 9001 - ISO 14001 E API 7F
CHAIN PRODUCED BY ISO 9001 - ISO 14001 AND API 7F CERTIFIED COMPANY

CATENA PRESTIRATA / PRE-STRETCHED CHAINS

CONFEZIONE DA 5 MT



ISO	codice	p		b ₁ mm min.	d ₁ mm max.	a ₂ mm max.	g mm max.	A mm	B mm	C mm max.	D mm	F mm	Carico di rottura		q kg/m ≈
		mm	inch										minimo KN	medio KN	
06B-1	603109222	9,525	3/8"	5,72	6,35	13,5	8,26	17,6	3,2	13,5	9,5	1,03	9,0	10,7	0,61
08B-1	603112222	12,7	1/2"	7,75	8,51	17,0	11,81	23,2	4,3	18,4	14,1	1,40	18,0	21,1	1,01
10B-1	603115222	15,875	5/8"	9,65	10,16	19,6	14,73	29,3	5,2	24,7	15,9	1,63	22,4	27,4	1,32
12B-1	603119222	19,05	3/4"	11,68	12,07	22,7	16,13	33,0	5,6	31,3	17,9	1,80	29,0	32,3	1,66
16B-1	603125222	25,4	1"	17,02	15,88	36,1	21,08	45,9	6,8	36,6	26,0	3,00	60,0	70,6	3,78



CATENE A RULLI CON PERNI SPORGENTI - DIN 8187 - ISO 606 EXTENDED PIN CHAINS - DIN 8187 - ISO 606

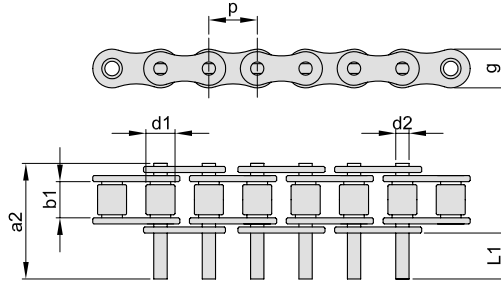

CATENA PRODOTTA DA AZIENDA CERTIFICATA ISO 9001 - ISO 14001 E API 7F
CHAIN PRODUCED BY ISO 9001 - ISO 14001 AND API 7F CERTIFIED COMPANY

CATENA PRESTIRATA / PRE-STRETCHED CHAINS

CONFEZIONE DA 5 MT



ISO	codice	p		b ₁ mm min.	d ₂ mm	d ₁ mm max.	L ₁ mm	a ₂ mm min.	g mm max.	Carico di rottura		q kg/m ≈
		mm	inch							minimo KN	medio KN	
06B-1	605109000	9,525	3/8"	5,72	3,28	6,35	11,10	22,75	8,26	9,0	10,7	0,47
08B-1	605112000	12,7	1/2"	7,75	4,45	8,51	15,15	30,91	11,81	18,0	21,1	0,75
10B-1	605115000	15,875	5/8"	9,65	5,08	10,16	17,63	35,26	14,73	22,4	27,4	1,07
12B-1	605119000	19,05	3/4"	11,68	5,72	12,07	20,83	41,66	16,13	29,0	32,3	1,22
16B-1	605125000	25,4	1"	17,02	8,28	15,88	33,80	67,58	21,08	60,0	70,6	3,03



CATENE PER ACCUMULO ACCUMULATOR CHAINS

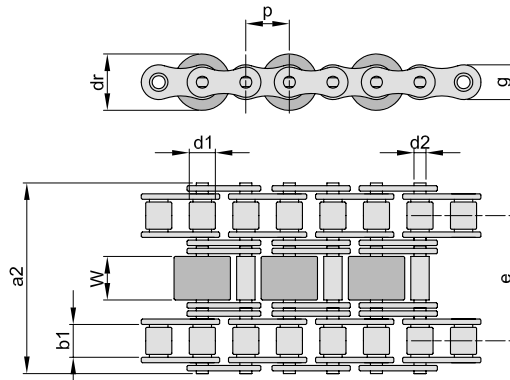

CATENA PRODOTTA DA AZIENDA CERTIFICATA ISO 9001 - ISO 14001 E API 7F
CHAIN PRODUCED BY ISO 9001 - ISO 14001 AND API 7F CERTIFIED COMPANY

CATENA PRESTIRATA / PRE-STRETCHED CHAINS

CONFEZIONE DA 5 MT



ISO	codice	p		b ₁ mm min.	d ₂ mm	d ₁ mm max.	a ₂ mm min.	g mm max.	e mm	dr mm max.	W mm	Carico di rottura		q kg/m ≈
		mm	inch									minimo KN	medio KN	
12B-3	602119000	19,05	3/4"	11,68	5,72	12,07	61,2	15,82	38,92	28,0	15,5	57,8	59,3	4,04



CATENE A RULLI NICHELATA - DIN 8187 - ISO 606 NICKEL PLATED ROLLER CHAINS - DIN 8187 - ISO 606

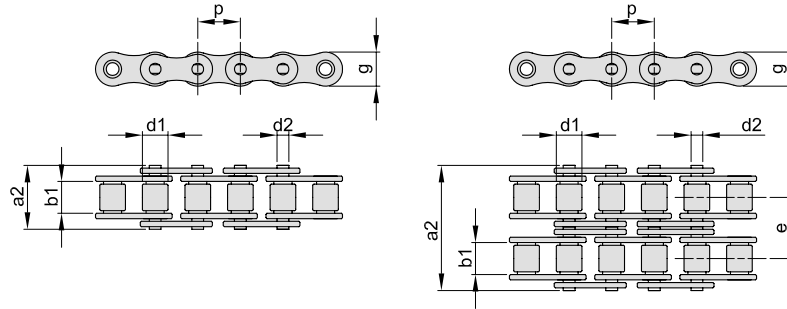

CATENA PRODOTTA DA AZIENDA CERTIFICATA ISO 9001 - ISO 14001 E API 7F
CHAIN PRODUCED BY ISO 9001 - ISO 14001 AND API 7F CERTIFIED COMPANY

CATENA PRESTIRATA / PRE-STRETCHED CHAINS



CONFEZIONE DA 5 MT

SEMPLICE

ISO	codice	p		b ₁ mm min.	d ₂ mm	d ₁ mm max.	a ₂ mm min.	g mm max.	Carico di rottura		q kg/m ≈
		mm	inch						minimo KN	medio KN	
06B-1	645109000	9,525	3/8"	5,72	3,28	6,35	13,5	8,26	9,0	10,7	0,40
08B-1	645112000	12,7	1/2"	7,75	4,45	8,51	17,0	11,81	18,0	21,1	0,68
10B-1	645115000	15,875	5/8"	9,65	5,08	10,16	19,6	14,73	22,4	27,4	0,91
12B-1	645119000	19,05	3/4"	11,68	5,72	12,07	22,7	16,13	29,0	32,3	1,12
16B-1	645125000	25,4	1"	17,02	8,28	15,88	36,1	21,08	60,0	70,6	2,59



DOPPIA

ISO	codice	p		b ₁ mm min.	d ₂ mm	d ₁ mm max.	a ₂ mm min.	g mm max.	e mm	Carico di rottura		q kg/m ≈
		mm	inch							minimo KN	medio KN	
06B-2	645109200	9,525	3/8"	5,72	3,28	6,35	23,8	8,26	10,24	16,9	19,2	0,76
08B-2	645112200	12,7	1/2"	7,75	4,45	8,51	31,0	11,81	13,92	32,0	38,0	1,31
10B-2	645115200	15,875	5/8"	9,65	5,08	10,16	36,2	14,73	16,59	44,5	57,3	1,79
12B-2	645119200	19,05	3/4"	11,68	5,72	12,07	42,2	16,13	19,46	57,8	65,7	2,22
16B-2	645125200	25,4	1"	17,02	8,28	15,88	68,0	21,08	31,88	113,7	137,5	5,03



CATENE A RULLI IN ACCIAIO "INOX AISI 304" - DIN 8187 - ISO 606

ROLLER CHAINS IN 304 STAINLESS STEEL - DIN 8187 - ISO 606

La catena INOX (AISI 304), costruita a rulli pieni, offre una particolare resistenza alla corrosione. Può essere utilizzata quindi in ambienti all'acqua, agli agenti chimici ed al calore. Opera a temperature da -20° a +400°.

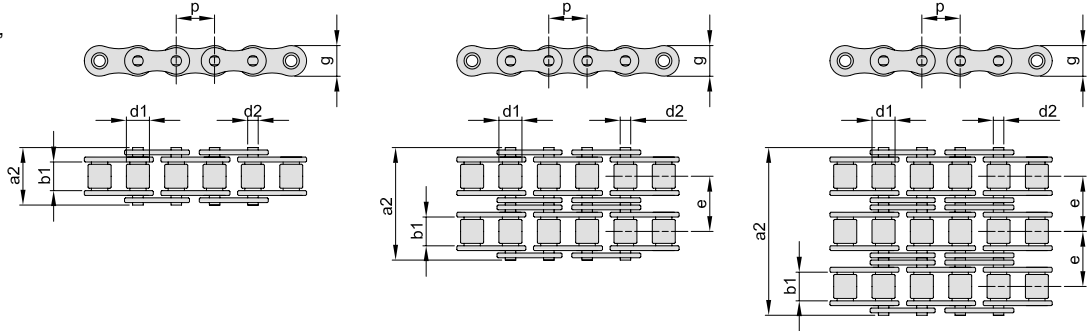

CATENA PRODOTTA DA AZIENDA CERTIFICATA ISO 9001 - ISO 14001 E API 7F
CHAIN PRODUCED BY ISO 9001 - ISO 14001 AND API 7F CERTIFIED COMPANY

CATENA PRESTIRATA / PRE-STRETCHED CHAINS



CONFEZIONE DA 5 MT

SEMPLICE

ISO	codice	p		b ₁ mm min.	d ₂ mm	d ₁ mm max.	a ₂ mm min.	g mm max.	Carico di rottura		q kg/m ≈
		mm	inch						minimo KN	medio KN	
06B-1	640109000	9,525	3/8"	5,72	3,28	6,35	13,5	8,26	6,6	6,9	0,40
08B-1	640112000	12,7	1/2"	7,75	4,45	8,51	17,0	11,81	12,0	12,7	0,68
10B-1	640115000	15,875	5/8"	9,65	5,08	10,16	19,6	14,73	15,0	16,8	0,91
12B-1	640119000	19,05	3/4"	11,68	5,72	12,07	22,7	16,13	17,0	17,5	1,12
16B-1	640125000	25,4	1"	17,02	8,28	15,88	36,1	21,08	40,0	41,0	2,59

DOPPIA

ISO	codice	p		b ₁ mm min.	d ₂ mm	d ₁ mm max.	a ₂ mm min.	g mm max.	e mm	Carico di rottura		q kg/m ≈
		mm	inch							minimo KN	medio KN	
06B-2	640109200	9,525	3/8"	5,72	3,28	6,35	23,8	8,26	10,24	10,5	12,8	0,76
08B-2	640112200	12,7	1/2"	7,75	4,45	8,51	31,0	11,81	13,92	22,0	24,4	1,31
10B-2	640115200	15,875	5/8"	9,65	5,08	10,16	36,2	14,73	16,59	28,4	33,8	1,79
12B-2	640119200	19,05	3/4"	11,68	5,72	12,07	42,2	16,13	19,46	33,3	35,6	2,22
16B-2	640125200	25,4	1"	17,02	8,28	15,88	68,0	21,08	31,88	74,4	79,0	5,03

TRIPLA

ISO	codice	p		b ₁ mm min.	d ₂ mm	d ₁ mm max.	a ₂ mm min.	g mm max.	e mm	Carico di rottura		q kg/m ≈
		mm	inch							minimo KN	medio KN	
06B-3	640109300	9,525	3/8"	5,72	3,28	6,35	34,0	8,26	10,24	17,8	18,6	1,12
08B-3	640112300	12,7	1/2"	7,75	4,45	8,51	44,9	11,81	13,92	30,6	31,8	1,94
10B-3	640115300	15,875	5/8"	9,65	5,08	10,16	52,8	14,73	16,59	42,6	49,5	2,68
12B-3	640119300	19,05	3/4"	11,68	5,72	12,07	61,7	16,13	19,46	50,0	52,2	3,32
16B-3	640125300	25,4	1"	17,02	8,28	15,88	99,9	21,08	31,88	111,7	117,6	7,65



CATENE A RULLI CON PIASTRE A PROFILO DIRITTO IN ACCIAIO "INOX AISI 304" - DIN 8187 - ISO 606
ROLLER CHAINS IN 304 STAINLESS STEEL WITH STRAIGHT PLATES - DIN 8187 - ISO 606

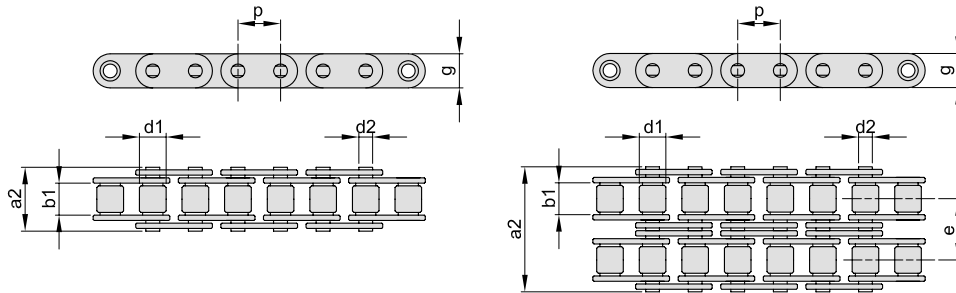

CATENA PRODOTTA DA AZIENDA CERTIFICATA ISO 9001 - ISO 14001 E API 7F
CHAIN PRODUCED BY ISO 9001 - ISO 14001 AND API 7F CERTIFIED COMPANY

CATENA PRESTIRATA / PRE-STRETCHED CHAINS



CONFEZIONE DA 5 MT

SEMPLICE

ISO	codice	p		b ₁ mm min.	d ₂ mm	d ₁ mm max.	a ₂ mm min.	g mm max.	Carico di rottura		q kg/m ≈
		mm	inch						minimo KN	medio KN	
08B-1	641112000	12,7	1/2"	7,75	4,45	8,51	17,0	11,6	12,0	12,7	0,78
12B-1	641119000	19,05	3/4"	11,68	5,72	12,07	22,7	15,9	17,0	17,5	1,30

DOPPIA

ISO	codice	p		b ₁ mm min.	d ₂ mm	d ₁ mm max.	a ₂ mm min.	g mm max.	e mm	Carico di rottura		q kg/m ≈
		mm	inch							minimo KN	medio KN	
08B-2	641112200	12,7	1/2"	7,75	4,45	8,51	31,0	11,6	13,92	22,0	24,4	1,55



CATENE A PERNI FORATI IN ACCIAIO "INOX AISI 304" - DIN 8187 - ISO 606
CHAINS IN 304 STAINLESS STEEL WITH HOLLOW PINS - DIN 8187 - ISO 606

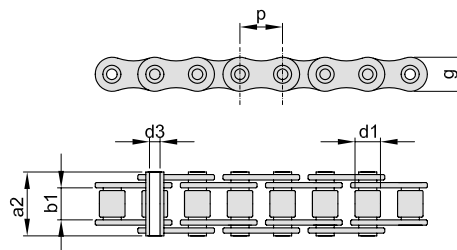

A RULLI

CATENA PRODOTTA DA AZIENDA CERTIFICATA ISO 9001 - ISO 14001 E API 7F
CHAIN PRODUCED BY ISO 9001 - ISO 14001 AND API 7F CERTIFIED COMPANY

CATENA PRESTIRATA / PRE-STRETCHED CHAINS



CONFEZIONE DA 5 MT

ISO	codice	p		b ₁ mm min.	d ₃ mm	d ₁ mm max.	a ₂ mm min.	g mm max.	Carico di rottura		q kg/m ≈
		mm	inch						minimo KN	medio KN	
08B-1	641512000	12,7	1/2"	7,75	4,50	8,51	17,0	11,6	8,3	10,6	0,58
10B-1	641515000	15,875	5/8"	9,65	5,18	10,16	19,6	14,5	11,8	13,9	0,77
12B-1	641519000	19,05	3/4"	11,68	5,85	12,07	22,7	15,9	12,0	17,2	0,98
16B-1	641525000	25,4	1"	17,02	8,33	15,88	36,1	20,5	20,0	36,0	2,21



GIUNTI E FALSE PER CATENA "BEA" CONNECTING LINK AND OFFSET LINK FOR ROLLER CHAINS "BEA"



Descrizione ISO	p mm	SERIE EUROPEA GIUNTI		FALSE	
		tipo	codice	tipo	codice
04-1	6	1	610106026		
05B-1	8	1	610108026		
05B-2	8	1	610108226		
06B-1	9,525	4	610109026	3	610109059
06B-2	9,525	4	610109226	3	610109259
06B-3	9,525	4	610109326	3	610109359
08B-1	12,7	1	610112026	3	610112059
08B-2	12,7	1	610112226	3	610112259
08B-3	12,7	1	610112326	3	610112359
10B-1	15,875	1	610115026	3	610115059
10B-2	15,875	1	610115226	3	610115259
10B-3	15,875	1	610115326	3	610115359
12B-1	19,05	1	610119026	3	610119059
12B-2	19,05	1	610119226	3	610119259
12B-3	19,05	1	610119326	3	610119359
16B-1	25,4	1	610125026	3	610125059
16B-2	25,4	1	610125226	3	610125259
16B-3	25,4	1	610125326	3	610125359
20B-1	31,75	2	610131026	3	610131059
20B-2	31,75	2	610131226	3	610131259
20B-3	31,75	2	610131326	3	610131359
24B-1	38,1	2	610138026	3	610138059
24B-2	38,1	2	610138226	3	610138259
24B-3	38,1	2	610138326	3	610138359
28B-1	44,45	2	610144026	3	610144059
28B-2	44,45	2	610144226	3	610144259
28B-3	44,45	2	610144326	3	610144359
32B-1	50,8	2	610150026	3	610150059
32B-2	50,8	2	610150226	3	610150259
32B-3	50,8	2	610150326	3	610150359
40B-1	63,5	2	610163026	3	610163059
40B-2	63,5	2	610163226	3	610163259

Descrizione ANSI	p mm	SERIE AMERICANA GIUNTI		FALSE	
		tipo	codice	tipo	codice
35-1	9,525	1	630035026	3	630035059
35-2	9,525	1	630035226	3	630035259
* 35-3	9,525	1	630035326	3	630035359
40-1	12,7	1	630040026	3	630040059
40-2	12,7	1	630040226	3	630040259
* 40-3	12,7	1	630040326	3	630040359
50-1	15,875	1	630050026	3	630050059
50-2	15,875	1	630050226	3	630050259
* 50-3	15,875	1	630050326	3	630050359
60-1	19,05	1	630060026	3	630060059
60-2	19,05	1	630060226	3	630060259
* 60-3	19,05	1	630060326	3	630060359
80-1	25,4	1	630080026	3	630080059
80-2	25,4	1	630080226	3	630080259
* 80-3	25,4	1	630080326	3	630080359
100-1	31,75	2	630100026	3	630100059
100-2	31,75	2	630100226	3	630100259
* 100-3	31,75	2	630100326	3	630100359
120-1	38,15	2	630120026	3	630120059
120-2	38,15	2	630120226	3	630120259
* 120-3	38,15	2	630120326	3	630120359
140-1	44,45	2	630140026	3	630140059
140-2	44,45	2	630140226	3	630140259
* 140-3	44,45	2	630140326	3	630140359
160-1	50,8	2	630160026	3	630160059
160-2	50,8	2	630160226	3	630160259
* 160-3	50,8	2	630160326	3	630160359
60-1H	19,05	1	631060026	3	631060059
80-1H	25,4	1	631080026	3	631080059
100-1H	31,75	2	631100026	3	631100059

* Costruiti a richiesta - manufactured on request.



GIUNTI E FALSE PER CATENA "BEA" CONNECTING LINK AND OFFSET LINK FOR ROLLER CHAINS "BEA"



A1



A2



K1

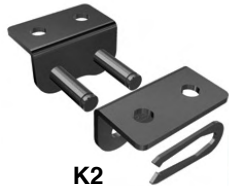

K2



M1



M2



MK1



MK2

Descrizione ISO	ATTACCHI ANGOLARI - A1/02				
	p mm	GIUNTI		FALSE	
		tipo	codice	tipo	codice
06B-1	9,525	A1	614109110		
08B-1	12,7	A1	614112110		
10B-1	15,875	A1	614115110		
12B-1	19,05	A1	614119110		
16B-1	25,4	A1	614125110		

Descrizione ISO	ATTACCHI VERTICALI - M1-02				
	p mm	GIUNTI		FALSE	
		tipo	codice	tipo	codice
06B-1	9,525	M1	613109110		
08B-1	12,7	M1	613112110		
10B-1	15,875	M1	613115110		
12B-1	19,05	M1	613119110		
16B-1	25,4	M1	613125110		

Descrizione ISO	ATTACCHI ANGOLARI - K1/02				
	p mm	GIUNTI		FALSE	
		tipo	codice	tipo	codice
06B-1	9,525	K1	614109210		
08B-1	12,7	K1	614112210		
10B-1	15,875	K1	614115210		
12B-1	19,05	K1	614119210		
16B-1	25,4	K1	614125210		

Descrizione ISO	ATTACCHI VERTICALI - MK1-02				
	p mm	GIUNTI		FALSE	
		tipo	codice	tipo	codice
06B-1	9,525	MK1	613109210		
08B-1	12,7	MK1	613112210		
10B-1	15,875	MK1	613115210		
12B-1	19,05	MK1	613119210		
16B-1	25,4	MK1	613125210		

Descrizione ISO	ATTACCHI ANGOLARI - A1/01				
	p mm	GIUNTI		FALSE	
		tipo	codice	tipo	codice
06B-1	9,525	A1	614109110		
08B-1	12,7	A1	614112110		
10B-1	15,875	A1	614115110		
12B-1	19,05	A1	614119110		
16B-1	25,4	A1	614125110		

Descrizione ISO	ATTACCHI VERTICALI - M1-01				
	p mm	GIUNTI		FALSE	
		tipo	codice	tipo	codice
06B-1	9,525	M1	613109110		
08B-1	12,7	M1	613112110		
10B-1	15,875	M1	613115110		
12B-1	19,05	M1	613119110		
16B-1	25,4	M1	613125110		

Descrizione ISO	ATTACCHI ANGOLARI - K1/01				
	p mm	GIUNTI		FALSE	
		tipo	codice	tipo	codice
06B-1	9,525	K1	614109210		
08B-1	12,7	K1	614112210		
10B-1	15,875	K1	614115210		
12B-1	19,05	K1	614119210		
16B-1	25,4	K1	614125210		

Descrizione ISO	ATTACCHI VERTICALI - MK1/01				
	p mm	GIUNTI		FALSE	
		tipo	codice	tipo	codice
06B-1	9,525	MK1	613109210		
08B-1	12,7	MK1	613112210		
10B-1	15,875	MK1	613115210		
12B-1	19,05	MK1	613119210		
16B-1	25,4	MK1	613125210		

Descrizione ISO	ATTACCHI ANGOLARI - A2/02				
	p mm	GIUNTI		FALSE	
		tipo	codice	tipo	codice
06B-1	9,525	A2	614109120		
08B-1	12,7	A2	614112120		
10B-1	15,875	A2	614115120		
12B-1	19,05	A2	614119120		
16B-1	25,4	A2	614125120		

Descrizione ISO	ATTACCHI VERTICALI - M2/02				
	p mm	GIUNTI		FALSE	
		tipo	codice	tipo	codice
06B-1	9,525	M2	613109120		
08B-1	12,7	M2	613112120		
10B-1	15,875	M2	613115120		
12B-1	19,05	M2	613119120		
16B-1	25,4	M2	613125120		

Descrizione ISO	ATTACCHI ANGOLARI - K2/02				
	p mm	GIUNTI		FALSE	
		tipo	codice	tipo	codice
06B-1	9,525	K2	614109220		
08B-1	12,7	K2	614112220		
10B-1	15,875	K2	614115220		
12B-1	19,05	K2	614119220		
16B-1	25,4	K2	614125220		

Descrizione ISO	ATTACCHI VERTICALI - MK2/02				
	p mm	GIUNTI		FALSE	
		tipo	codice	tipo	codice
06B-1	9,525	MK2	613109220		
08B-1	12,7	MK2	613112220		
10B-1	15,875	MK2	613115220		
12B-1	19,05	MK2	613119220		
16B-1	25,4	MK2	613125220		



GIUNTI E FALSE PER CATENA "BEA" CONNECTING LINK AND OFFSET LINK FOR ROLLER CHAINS "BEA"

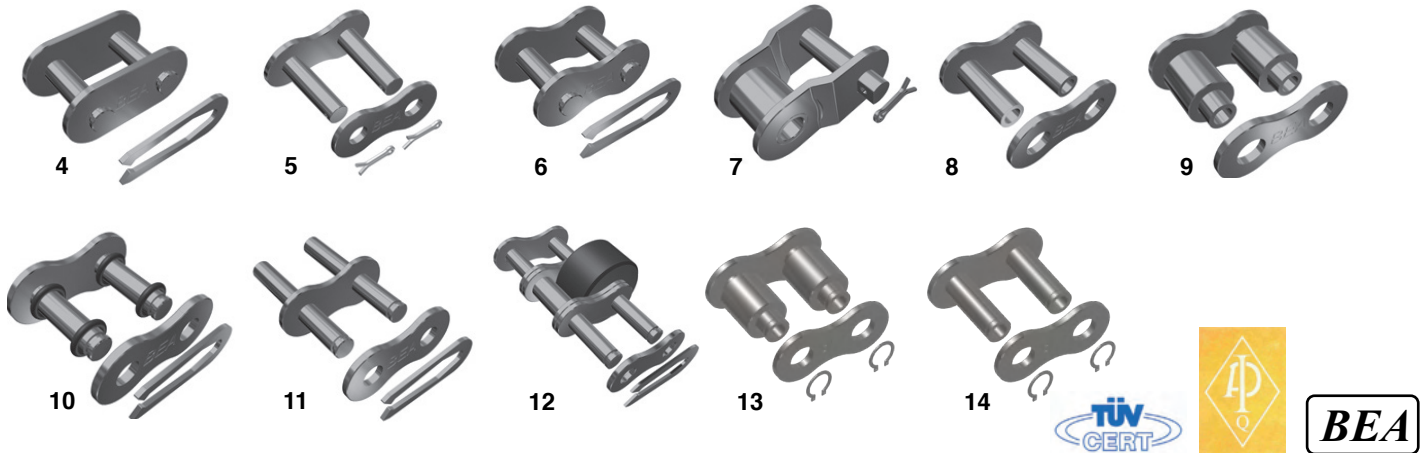

Descrizione ISO	p mm	PIASTRE A PROFILO DIRITTO GIUNTI		FALSE	
		tipo	codice	tipo	codice
08B-1	12,7	4	611112026		
10B-1	15,875	4	611115026		
10B-2	15,875	4	611115226		
12B-1	19,05	4	611119026		
12B-2	19,05	4	611119226		
16B-1	25,4	4	611125026		
16B-2	25,4	4	611125226		
20B-1	31,75	5	611131026		
20B-2	31,75	5	611131226		

Descrizione ISO	p mm	NICHELATA GIUNTI		FALSE	
		tipo	codice	tipo	codice
06B-1	9,525	6	646109026	7	646109059
06B-2	9,525	6	646109226	7	646109259
08B-1	12,7	6	646112026	7	646112059
08B-2	12,7	6	646112226	7	646112259
10B-1	15,875	6	646115026	7	646115059
10B-2	15,875	6	646115226	7	646115259
12B-1	19,05	6	646119026	7	646119059
12B-2	19,05	6	646119226	7	646119259
16B-1	25,4	6	646125026	7	646125059
16B-2	25,4	6	646125226	7	646125259

Descrizione ISO	p mm	PERNO FORATO TIPO "A" - A BUSSOLA GIUNTI		FALSE	
		tipo	codice	tipo	codice
08B-1	12,7	14	611512026		
10B-1	15,875	8	611515026		
12B-1	19,05	8	611519026		

Descrizione ISO	p mm	PERNO FORATO TIPO "B" - A RULLI GIUNTI		FALSE	
		tipo	codice	tipo	codice
08B-1	12,7	9	611612026		
10B-1	15,875	13	611615026		
12B-1	19,05	13	611619026		
16B-1	25,4	13	611625026		

Descrizione ISO	p mm	AUTOLUBRIFICATA GIUNTI		FALSE	
		tipo	codice	tipo	codice
08B-1	12,7				
10B-1	15,875				
12B-1	19,05				

Descrizione ISO	p mm	"O-RING" GIUNTI		FALSE	
		tipo	codice	tipo	codice
08B-1	12,7	10	644112026		
10B-1	15,875	10	644115026		

Descrizione ISO	p mm	PERNI SPORGENTI GIUNTI		FALSE	
		tipo	codice	tipo	codice
06B-1	9,525	11	615109026		
08B-1	12,7	11	615112026		
10B-1	15,875	11	615115026		
12B-1	19,05	11	615119026		
16B-1	25,4	11	615125026		

Descrizione ISO	p mm	ACCUMULO GIUNTI		FALSE	
		tipo	codice	tipo	codice
12B-3	19,50	12	612119026		



GIUNTI E FALSE PER CATENA INOX "BEA" CONNECTING LINK AND OFFSET LINK FOR ROLLER CHAINS IN STAINLESS STEEL "BEA"



1



3



4



9



13



Descrizione ISO	p mm	SERIE EUROPEA GIUNTI		FALSE	
		tipo	codice	tipo	codice
06B-1	9,525	4	650109026	3	650109059
06B-2	9,525	4	650109226	3	650109259
06B-3	9,525	4	650109326	3	650109359
08B-1	12,7	1	650112026	3	650112059
08B-2	12,7	1	650112226	3	650112259
08B-3	12,7	1	650112326	3	650112359
10B-1	15,875	1	650115026	3	650115059
10B-2	15,875	1	650115226	3	650115259
10B-3	15,875	1	650115326	3	650115359
12B-1	19,05	1	650119026	3	650119059
12B-2	19,05	1	650119226	3	650119259
12B-3	19,05	1	650119326	3	650119359
16B-1	25,4	1	650125026	3	650125059
16B-2	25,4	1	650125226	3	650125259
16B-3	25,4	1	650125326	3	650125359

Descrizione ANSI	p mm	GIUNTI		FALSE	
		tipo	codice	tipo	codice

Descrizione ISO	p mm	PIASTRE A PROFILO DIRITTO GIUNTI		FALSE	
		tipo	codice	tipo	codice
08B-1	12,7	4	651112026		
08B-2	12,7	4	651112226		
12B-1	19,05	4	651119026		

Descrizione ANSI	p mm	PERNI FORATI - A RULLI GIUNTI		FALSE	
		tipo	codice	tipo	codice
08B-1	12,7	13	651512026		
10B-1	15,875	9	651515026		
12B-1	19,05	9	651519026		
16B-1	25,4	9	651525026		

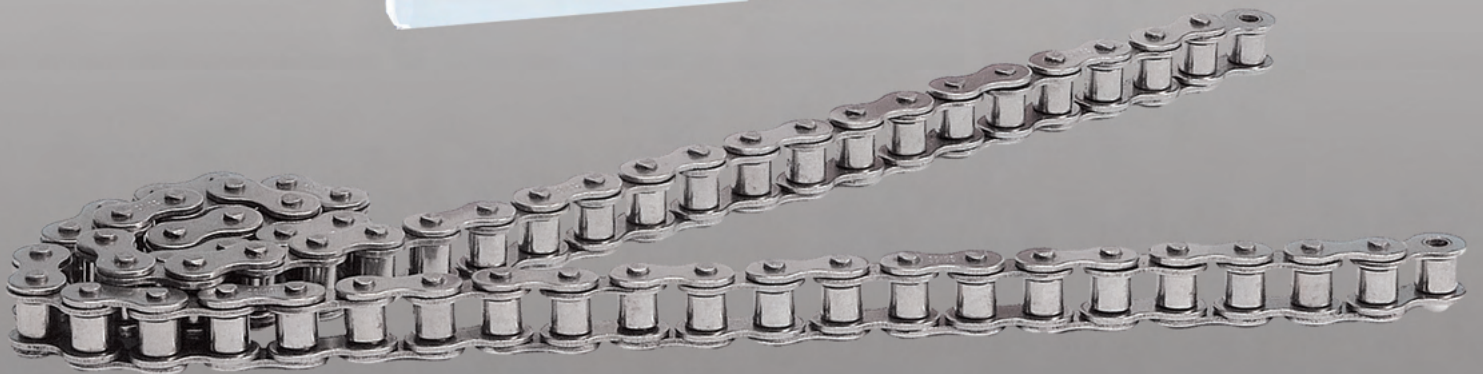



CATENE A RULLI SERIE EUROPEA "SATURN" - DIN 8187 - ISO 606

ROLLER CHAINS EUROPEAN STANDARD "SATURN" - DIN 8187 - ISO 606

Le catene a rulli serie europea "Saturn" possono operare a temperature da -10° a +150°

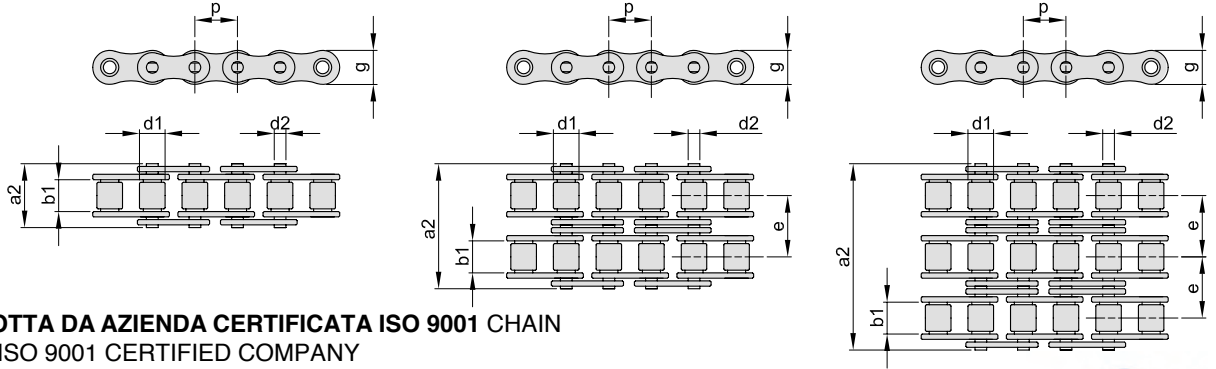

CATENA PRODOTTA DA AZIENDA CERTIFICATA ISO 9001 CHAIN
PRODUCED BY ISO 9001 CERTIFIED COMPANY

CATENA PRESTIRATA / PRE-STRETCHED CHAINS

CONFEZIONI DA 5 MT - ROTOLI DA ▲ 50 MT - ROTOLI DA ■ 100 MT



SEMPLICE

ISO	codice	p		b ₁ mm min.	d ₂ mm	d ₁ mm max.	a ₂ mm max.	g mm max.	F _B min KN	q kg/m ≈
		mm	inch							
03-1	700105000	5	-	2,50	1,49	3,20	7,4	4,10	2,2	0,08
04-1	700106000	6	-	2,80	1,85	4,00	7,4	5,00	3,0	0,12
05B-1	700108000	8	-	3,00	2,31	5,00	8,6	7,11	4,4	0,18
06B-1	700109000	9,525	3/8"	5,72	3,28	6,35	13,5	8,26	8,9	0,40
06B-1 ■	700109075	9,525	3/8"	5,72	3,28	6,35	13,5	8,26	8,9	0,40
081-1	700212000	12,7	1/2"	3,30	3,66	7,75	10,2	9,91	8,0	0,28
081-1 ■	700212150	12,7	1/2"	3,30	3,66	7,75	10,2	9,91	8,0	0,28
083-1	700511000	12,7	1/2"	4,88	4,09	7,75	12,9	12,00	12,0	0,42
084-1	700512000	12,7	1/2"	4,88	4,09	7,75	14,8	12,00	14,4	0,49
08B-1	700112000	12,7	1/2"	7,75	4,45	8,51	17,0	11,81	17,8	0,68
08B-1 ▲	700112050	12,7	1/2"	7,75	4,45	8,51	17,0	11,81	17,8	0,68
10B-1	700115000	15,875	5/8"	9,65	5,08	10,16	19,6	14,73	22,2	0,91
10B-1 ▲	700115050	15,875	5/8"	9,65	5,08	10,16	19,6	14,73	22,2	0,91
12B-1	700119000	19,05	3/4"	11,68	5,72	12,07	22,7	16,13	28,9	1,12
16B-1	700125000	25,4	1"	17,02	8,28	15,88	36,1	21,08	60,0	2,59
20B-1	700131000	31,75	1 1/4"	19,56	10,19	19,05	43,2	26,42	95,0	3,68
24B-1	700138000	38,1	1 1/2"	25,40	14,63	25,40	53,4	33,40	160,0	6,85
28B-1	700144000	44,45	1 3/4"	30,99	15,90	27,94	65,1	37,08	200,0	8,56
32B-1	700150000	50,8	2"	30,99	17,81	29,21	67,4	42,29	250,0	9,49
40B-1	700163000	63,5	2 1/2"	38,10	22,89	39,37	82,6	52,90	355,0	15,55
48B-1	700176000	76,2	3"	45,72	29,24	48,26	99,1	63,80	560,0	24,45

DOPPIA

ISO	codice	p		b ₁ mm min.	d ₂ mm	d ₁ mm max.	a ₂ mm max.	g mm max.	e mm	F _B min KN	q kg/m ≈
		mm	inch								
05B-2	700108200	8	-	3,00	2,31	5,00	14,3	7,11	5,64	7,8	0,32
06B-2	700109200	9,525	3/8"	5,72	3,28	6,35	23,8	8,26	10,24	16,9	0,76
08B-2	700112200	12,7	1/2"	7,75	4,45	8,51	31,0	11,81	13,92	31,1	1,31
10B-2	700115200	15,875	5/8"	9,65	5,08	10,16	36,2	14,73	16,59	44,5	1,79
12B-2	700119200	19,05	3/4"	11,68	5,72	12,07	42,2	16,13	19,46	57,8	2,50
16B-2	700125200	25,4	1"	17,02	8,28	15,88	68,0	21,08	31,88	106,0	5,03
20B-2	700131200	31,75	1 1/4"	19,56	10,19	19,05	79,7	26,42	36,45	170,0	7,33
24B-2	700138200	38,1	1 1/2"	25,40	14,63	25,40	101,8	33,40	48,36	280,0	13,50
28B-2	700144200	44,45	1 3/4"	30,99	15,90	27,94	124,7	37,08	59,56	360,0	16,96
32B-2	700150200	50,8	2"	30,99	17,81	29,21	126,0	42,99	58,55	450,0	18,74
40B-2	700163200	63,5	2 1/2"	38,10	22,89	39,37	154,0	52,90	72,29	630,0	30,72
48B-2	700176200	76,2	3"	45,72	29,24	48,26	190,0	63,80	91,21	1000,0	48,54

TRIPLA

ISO	codice	p		b ₁ mm min.	d ₂ mm	d ₁ mm max.	a ₂ mm max.	g mm max.	e mm	F _B min KN	q kg/m ≈
		mm	inch								
06B-3	700109300	9,525	3/8"	5,72	3,28	6,35	34,0	8,26	10,24	24,9	1,12
08B-3	700112300	12,7	1/2"	7,75	4,45	8,51	44,9	11,81	13,92	44,5	1,94
10B-3	700115300	15,875	5/8"	9,65	5,08	10,16	52,8	14,73	16,59	66,7	2,68
12B-3	700119300	19,05	3/4"	11,68	5,72	12,07	61,7	16,13	19,46	86,7	3,32
16B-3	700125300	25,4	1"	17,02	8,28	15,88	99,9	21,08	31,88	160,0	7,65
20B-3	700131300	31,75	1 1/4"	19,56	10,19	19,05	116,1	26,42	36,45	250,0	10,96
24B-3	700138300	38,1	1 1/2"	25,40	14,63	25,40	150,2	33,40	48,36	425,0	20,20
28B-3	700144300	44,45	1 3/4"	30,99	15,90	27,94	184,3	37,08	59,56	530,0	25,38
32B-3	700150300	50,8	2"	30,99	17,81	29,21	184,5	42,99	58,55	670,0	28,04
40B-3	700163300	63,5	2 1/2"	38,10	22,89	39,37	227,0	52,90	72,29	950,0	45,90
48B-3	700176300	76,2	3"	45,72	29,24	48,26	281,0	63,80	91,21	1500,0	72,50



CATENE A RULLI CON PIASTRE A PROFILO DIRITTO "SATURN" - DIN 8187 - ISO 606

ROLLER CHAINS WITH STRAIGHT PLATES "SATURN" - DIN 8187 - ISO 606

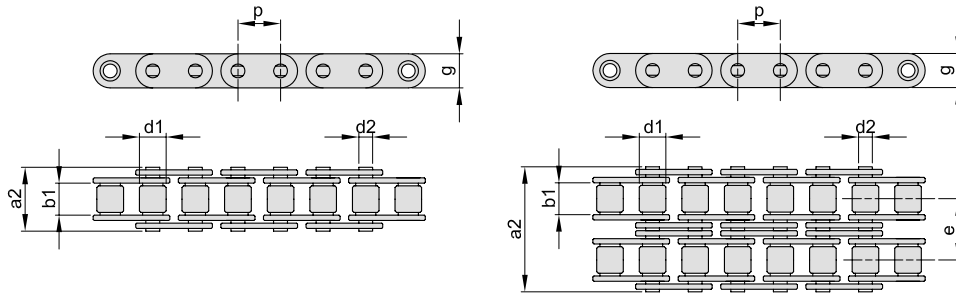

CATENA PRODOTTA DA AZIENDA CERTIFICATA ISO 9001
CHAIN PRODUCED BY ISO 9001 CERTIFIED COMPANY

CATENA PRESTIRATA / PRE-STRETCHED CHAINS

CONFEZIONI DA 5 MT



SEMPLICE

ISO	codice	p		b ₁ mm min.	d ₂ mm	d ₁ mm max.	a ₂ mm max.	g mm max.	F _B min KN	q kg/m ≈
		mm	inch							
08B-1	701112000	12,7	1/2"	7,75	4,45	8,51	17,0	11,8	18,0	0,75
10B-1	701115000	15,875	5/8"	9,65	5,08	10,16	19,6	14,7	22,4	0,98
12B-1	701119000	19,05	3/4"	11,68	5,72	12,07	22,7	16,0	29,0	1,24
16B-1	701125000	25,4	1"	17,02	8,28	15,88	36,1	21,0	60,0	2,82

DOPPIA

ISO	codice	p		b ₁ mm min.	d ₂ mm	d ₁ mm max.	a ₂ mm max.	g mm max.	e mm	F _B min KN	q kg/m ≈
		mm	inch								
10B-2	701115200	15,875	5/8"	9,65	5,08	10,16	36,1	14,7	16,59	44,5	1,97
12B-2	701119200	19,05	3/4"	11,68	5,72	12,07	42,0	16,0	19,46	57,8	2,27
16B-2	701125200	25,4	1"	17,02	8,28	15,88	68,0	21,0	31,88	106,0	5,78



CATENE A RULLI IN ACCIAIO "INOX AISI 304 - SATURN" - DIN 8187 - ISO 606

ROLLER CHAINS IN 304 STAINLESS STEEL - "SATURN" - DIN 8187 - ISO 606

La catena INOX (AISI 304), costruita a rulli pieni, offre una particolare resistenza alla corrosione. Può essere utilizzata quindi in ambienti all'acqua, agli agenti chimici ed al calore. Opera a temperature da -20° a +400°.

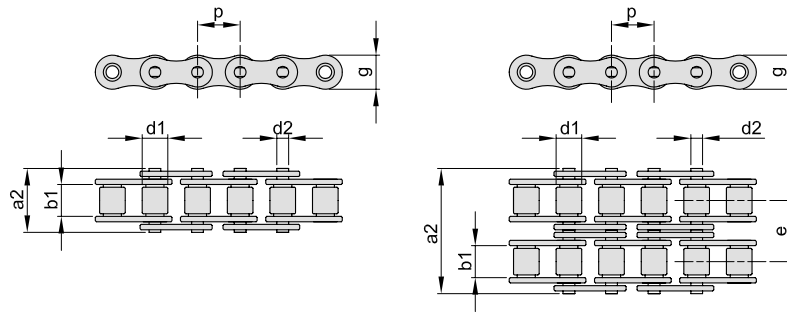

CATENA PRODOTTA DA AZIENDA CERTIFICATA ISO 9001
CHAIN PRODUCED BY ISO 9001 CERTIFIED COMPANY

CATENA PRESTIRATA / PRE-STRETCHED CHAINS



CONFEZIONI DA 5 MT

SEMPLICE

ISO	codice	p		b ₁ mm min.	d ₂ mm	d ₁ mm max.	a ₂ mm max.	g mm max.	F _B min KN	q kg/m ≈
		mm	inch							
06B-1	740109000	9,525	3/8"	5,72	3,28	6,35	13,5	8,26	6,6	0,40
08B-1	740112000	12,7	1/2"	7,75	4,45	8,51	17,0	11,81	12,0	0,68
10B-1	740115000	15,875	5/8"	9,65	5,08	10,16	19,6	14,73	15,0	0,91
12B-1	740119000	19,05	3/4"	11,68	5,72	12,07	22,7	16,13	17,0	1,12
16B-1	740125000	25,4	1"	17,02	8,28	15,88	36,1	21,08	40,0	2,59

DOPPIA

ISO	codice	p		b ₁ mm min.	d ₂ mm	d ₁ mm max.	a ₂ mm max.	g mm max.	e mm	F _B min KN	q kg/m ≈
		mm	inch								
06B-2	740109200	9,525	3/8"	5,72	3,28	6,35	23,8	8,26	10,24	10,5	0,76
08B-2	740112200	12,7	1/2"	7,75	4,45	8,51	31,0	11,81	13,92	22,0	1,31
10B-2	740115200	15,875	5/8"	9,65	5,08	10,16	36,2	14,73	16,59	28,4	1,79
12B-2	740119200	19,05	3/4"	11,68	5,72	12,07	42,2	16,13	19,46	33,3	2,22
16B-2	740125200	25,4	1"	17,02	8,28	15,88	68,0	21,08	31,88	74,4	5,03



GIUNTI E FALSE PER CATENA INOX "SATURN"

CONNECTING LINK AND OFFSET LINK FOR ROLLER CHAINS IN STAINLESS STEEL "SATURN"



1



3



4



Descrizione ISO	p mm	SERIE EUROPEA GIUNTI		FALSE	
		tipo	codice	tipo	codice
06B-1	9,525	4	750109026	3	750109059
06B-2	9,525	4	750109226	3	750109259
08B-1	12,7	1	750112026	3	750112059
08B-2	12,7	1	750112226	3	750112259
10B-1	15,875	1	750115026	3	750115059
10B-2	15,875	1	750115226	3	750115259
12B-1	19,05	1	750119026	3	750119059
12B-2	19,05	1	750119226	3	750119259
16B-1	25,4	1	750125026	3	750125059
16B-2	25,4	1	750125226	3	750125259

Descrizione ANSI	p mm	GIUNTI		FALSE	
		tipo	codice	tipo	codice

Descrizione ISO	p mm	GIUNTI tipo	GIUNTI codice	FALSE tipo	FALSE codice

Descrizione ANSI	p mm	GIUNTI tipo	GIUNTI codice	FALSE tipo	FALSE codice



GUIDACATENE IN POLIETILENE CHAIN GUIDE RAILS IN POLYETHYLENE

PROFILO "T" PER CATENA SEMPLICE - lunghezza 2 metri

tipo	catena	codice	ISO	B	A	b	a	Kg./Mt.
T 0	3/8" x 7/32"	6011013301	06B1	15	10	5,4	1,5	0,13
T 1	1/2" x 5/16"	6011013401	08B1	20	10	7,4	2,2	0,18
T 1	1/2" x 5/16"	6011013402	08B1	20	15	7,4	2,2	0,26
T 1	1/2" x 5/16"	6011013403	08B1	20	20	7,4	2,2	0,34
T 2	5/8" x 3/8"	6011013501	10B1	20	10	9,2	2,6	0,16
T 2	5/8" x 3/8"	6011013502	10B1	20	15	9,2	2,6	0,25
T 2	5/8" x 3/8"	6011013503	10B1	20	20	9,2	2,6	0,33
T 3	3/4" x 7/16"	6011013601	12B1	25	10	11,3	2,4	0,20
T 3	3/4" x 7/16"	6011013602	12B1	25	15	11,3	2,4	0,32
T 3	3/4" x 7/16"	6011013603	12B1	25	20	11,3	2,4	0,43
T 4	1" x 17,02	6011013801	16B1	40	15	16,5	3,5	0,45
T 4	1" x 17,02	6011013802	16B1	40	20	16,5	3,5	0,68
T 5	1" 1/4 x 3/4"	6011014001	20B1	45	15	19,0	4,3	0,55
T 5	1" 1/4 x 3/4"	6011014002	20B1	45	20	19,0	4,3	0,77
T 6	1" 1/2 x 1"	6011014201	24B1	60	15	24,6	5,6	0,67
T 6	1" 1/2 x 1"	6011014202	24B1	60	20	24,6	5,6	0,97
* T 7	1" 3/4 x 1" 1/4	6011014401	28B1	75	20	30,0	6,9	
* T 8	2" x 1" 1/4	6011014601	32B1	80	20	30,0	7,8	

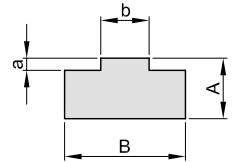

PROFILO "T" PER CATENA DOPPIA - lunghezza 2 metri

tipo	catena	codice	ISO	B	A	b	a	c	Kg./Mt.
T 0.2	3/8" x 7/32"	6011023301	06B2	25	10	5,4	1,5	15,74	0,22
T 1.2	1/2" x 5/16"	6011023401	08B2	35	10	7,4	2,2	21,42	0,30
T 1.2	1/2" x 5/16"	6011023402	08B2	35	15	7,4	2,2	21,42	0,46
T 1.2	1/2" x 5/16"	6011023403	08B2	35	20	7,4	2,2	21,42	0,63
T 2.2	5/8" x 3/8"	6011023501	10B2	40	10	9,2	2,6	25,79	0,32
T 2.2	5/8" x 3/8"	6011023502	10B2	40	15	9,2	2,6	25,79	0,54
T 2.2	5/8" x 3/8"	6011023503	10B2	40	20	9,2	2,6	25,79	0,77
T 3.2	3/4" x 7/16"	6011023601	12B2	45	15	11,3	2,4	30,76	0,62
T 3.2	3/4" x 7/16"	6011023602	12B2	45	20	11,3	2,4	30,76	0,85
T 4.2	1" x 17,02	6011023801	16B2	65	15	16,5	3,5	48,38	0,86
T 4.2	1" x 17,02	6011023802	16B2	65	20	16,5	3,5	48,38	1,19
T 5.2	1" 1/4 x 3/4"	6011024001	20B2	70	15	19,0	4,3	54,45	0,89
T 5.2	1" 1/4 x 3/4"	6011024002	20B2	70	20	19,0	4,3	54,45	1,22
T 6.2	1" 1/2 x 1"	6011024201	24B2	88	20	24,6	5,6	72,96	1,48
* T 7.2	1" 3/4 x 1" 1/4	6011024401	28B2	105	25	30,0	6,9	89,56	
* T 8.2	2" x 1" 1/4	6011024601	32B2	105	30	30,0	7,8	88,55	

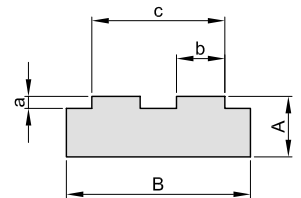

PROFILO "T" PER CATENA TRIPLA - lunghezza 2 metri

tipo	catena	codice	ISO	B	A	b	a	c	Kg./Mt.
T 0.3	3/8" x 7/32"	6011033301	06B3	35	10	5,4	1,5	25,88	0,77
T 1.3	1/2" x 5/16"	6011033401	08B3	45	10	7,4	2,2	35,24	0,82
T 1.3	1/2" x 5/16"	6011033402	08B3	45	15	7,4	2,2	35,24	1,06
T 1.3	1/2" x 5/16"	6011033403	08B3	45	20	7,4	2,2	35,24	1,27
T 2.3	5/8" x 3/8"	6011033501	10B3	55	10	9,2	2,6	42,38	0,85
T 2.3	5/8" x 3/8"	6011033502	10B3	55	15	9,2	2,6	42,38	1,13
T 2.3	5/8" x 3/8"	6011033503	10B3	55	20	9,2	2,6	42,38	1,40
T 3.3	3/4" x 7/16"	6011033601	12B3	60	15	11,3	2,4	50,22	0,86
T 3.3	3/4" x 7/16"	6011033602	12B3	60	20	11,3	2,4	50,22	1,16
T 4.3	1" x 17,02	6011033801	16B3	95	20	16,5	3,5	80,26	1,75

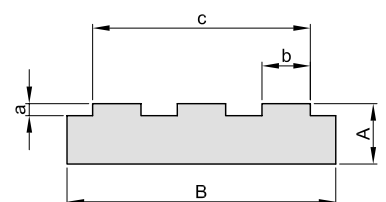

* Costruiti a richiesta
manufactured on request.



GUIDACATENE IN POLIETILENE CHAIN GUIDE RAILS IN POLYETHYLENE

PROFILO "E" PER CATENA SEMPLICE - lunghezza 2 metri

tipo	catena	codice	ISO	B	A	a	a1	b	b1	Kg/Mt.
E 0	3/8" x 7/32"	6011043301	06B1	25	10	1,5	4,35	5,4	15	0,17
E 1	1/2" x 5/16"	6011043401	08B1	30	15	2,2	7,17	7,4	20	0,27
E 2	5/8" x 3/8"	6011043501	10B1	33	20	2,6	9,45	9,2	23	0,39
E 3	3/4" x 7/16"	6011043601	12B1	38	20	2,4	11,11	11,3	28	0,39
E 4	1" x 17,02	6011043801	16B1	51	25	3,5	16,48	16,5	41	0,46

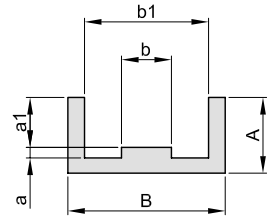

PROFILO "E" PER CATENA DOPPIA - lunghezza 2 metri

tipo	catena	codice	ISO	B	A	a	a1	b	c1	Kg/Mt.
E 0.2	3/8" x 7/32"	6011053301	06B2	36	15	1,5	4,35	5,4	26	0,43
E 1.2	1/2" x 5/16"	6011053401	08B2	45	20	2,2	7,17	7,4	35	0,59
E 2.2	5/8" x 3/8"	6011053501	10B2	50	25	2,6	9,45	9,2	40	0,77
E 3.2	3/4" x 7/16"	6011053601	12B2	56	25	2,4	11,11	11,3	46	0,80
E 4.2	1" x 17,02	6011053801	16B2	85	30	3,5	16,48	16,5	75	1,12

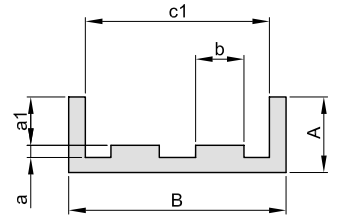

PROFILO "BL" PER CATENA SEMPLICE - lunghezza 2 metri

tipo	catena	codice	ISO	B	A	a1	a2	a3	d1	D	d2	Kg/Mt.
BL 0	3/8" x 7/32"	6011073301	06B1	20	25	5,6	8,7	10,0	6,6	9,3	4,0	0,43
BL 1	1/2" x 5/16"	6011073401	08B1	24	30	7,6	11,5	13,5	8,7	12,8	5,0	0,55
BL 2	5/8" x 3/8"	6011073501	10B1	30	35	9,5	13,5	14,8	10,4	15,4	6,0	0,83
BL 3	3/4" x 7/16"	6011073601	12B1	40	35	11,5	15,9	17,5	12,3	16,9	7,0	1,10
BL 4	1" x 17,02	6011073801	16B1	40	45	16,9	25,7	26,8	16,1	24,4	9,0	1,22
* BL 5	1" 1/4 x 3/4"	6011074001	20B1	50	50	19,4	29,3	31,2	19,3	27,5	11,0	
* BL 6	1" 1/2 x 1"	6011074201	24B1	60	60	25,2	38,2	40,1	25,7	36,5	16,0	
* BL 7	1" 3/4 x 1" 1/4	6011074401	28B1	60	70	30,8	46,9	48,9	28,3	41,5	17,0	
* BL 8	2" x 1" 1/4	6011074601	32B1	70	75	30,8	47,3	53,0	29,6	44,5	19,0	

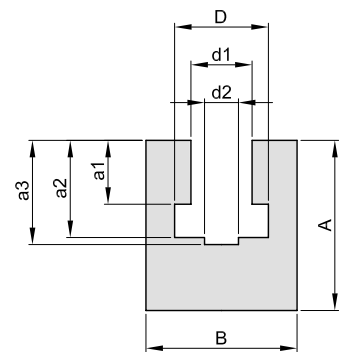

PROFILO "U" PER CATENA SEMPLICE - lunghezza 2 metri

tipo	catena	codice	ISO	B	A	a2	a3	d1	d2	Kg/Mt.
U 0	3/8" x 7/32"	6011083301	06B1	20	15	2,8	4,2	9,2	4	0,26
U 1	1/2" x 5/16"	6011083401	08B1	25	15	3,5	4,8	12,7	5	0,31
U 2	5/8" x 3/8"	6011083501	10B1	25	15	3,6	5,1	15,2	6	0,30
U 3	3/4" x 7/16"	6011083601	12B1	25	20	3,9	5,7	16,7	7	0,40
U 4	1" x 17,02	6011083801	16B1	35	25	8,4	10,0	24,4	9	0,63

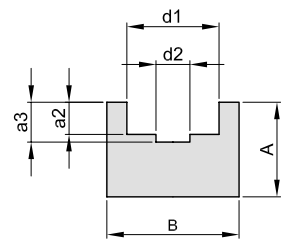

PROFILO "CT" PER CATENA SEMPLICE - lunghezza 2 metri

tipo	catena	codice	ISO	B	A	a	b	Ac	Kg/Mt.
T 0 C3 A 15	3/8" x 7/32"	6011113301	06B1	20	15	1,5	5,4	17	0,69
T 1 C3 A 15	1/2" x 5/16"	6011113401	08B1	20	15	2,2	7,4	17	0,68
T 2 C3 A 15	5/8" x 3/8"	6011113501	10B1	20	15	2,6	9,2	17	0,67
T 3 C3 A 15	3/4" x 7/16"	6011113601	12B1	20	15	2,4	11,3	17	0,68
T 4 C5 A 15	1" x 17,02	6011113801	16B1	28	15	3,5	16,5	18	0,93
T 5 C9 A 20	1 1/4" x 3/4"	6011114001	20B1	38	20	4,3	19,0	27	1,51

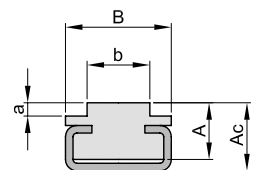

* Costruiti a richiesta
manufactured on request.

GUIDACATENA PREDISPOSTA PER PROFILO METALLICO DA ORDINARE SEPARATAMENTE



GUIDACATENE IN POLIETILENE CHAIN GUIDE RAILS IN POLYETHYLENE

PROFILO "CT" PER CATENA DOPPIA - lunghezza 2 metri

tipo	catena	codice	ISO	B	A	a	b	Ac	Kg./Mt.
T 0.2 C3 A 15	3/8" x 7/32"	6011123301	06B2	15,7	15	1,5	5,4	17	0,66
T 1.2 C3 A 15	1/2" x 5/16"	6011123401	08B2	21,4	15	2,2	7,4	17	0,70
T 2.2 C5 A 15	5/8" x 3/8"	6011123501	10B2	25,9	15	2,6	9,2	19	0,95
T 3.2 C5 A 15	3/4" x 7/16"	6011123601	12B2	30,7	15	2,4	11,3	19	0,97
T 4.2 C9 A 20	1" x 17,02	6011123801	16B2	48,3	20	3,5	16,5	27	1,61

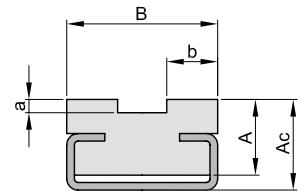

GUIDACATENA PREDISPOSTA PER PROFILO METALLICO DA ORDINARE SEPARATAMENTE

PROFILO "C 10 P" PER CATENA SEMPLICE - lunghezza 2 metri

tipo	catena	codice	ISO	B	A	b	a	Kg./Mt.
C 10.0	3/8" x 7/32"	6011143301	06B1	30	24	6,6	5,6	1,39
C 10.1	1/2" x 5/16"	6011143401	08B1	30	24	8,7	7,6	1,33
C 10.2	5/8" x 3/8"	6011143501	10B1	30	24	10,4	9,5	1,29
C 10.3	3/4" x 7/16"	6011143601	12B1	30	24	12,3	11,5	1,23
C 11.4	1" x 17,02	6011143801	16B1	45	40	16,1	16,9	2,92

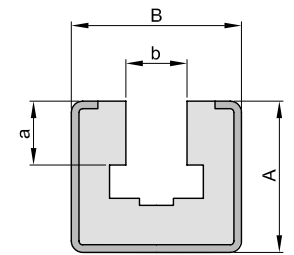

GUIDACATENA PREDISPOSTA PER PROFILO METALLICO DA ORDINARE SEPARATAMENTE

PROFILO "COMBI A-R" PER CATENA SEMPLICE - lunghezza 2 metri

tipo	catena	codice	ISO	Prof. met.	A	B	A1	A2	Ac	b	Kg./Mt.
COMBI 0	3/8" x 7/32"	6011153301	06B1	C 3	26,4	20	31,6	19,5	28,4	14,5	0,84
COMBI 1	1/2" x 5/16"	6011153401	08B1	C 3	28,0	20	34,8	18,9	30,5	16,5	0,81
COMBI 2	5/8" x 3/8"	6011153501	10B1	C 3	34,4	20	41,1	21,2	36,0	15,5	0,87
COMBI 3	3/4" x 7/16"	6011153601	12B1	C 5	38,5	28	47,5	24,8	41,5	18,5	1,36
COMBI 4	1" x 17,02	6011153801	16B1	C 9	52,4	38	69,4	45,1	61,4	25,0	2,25

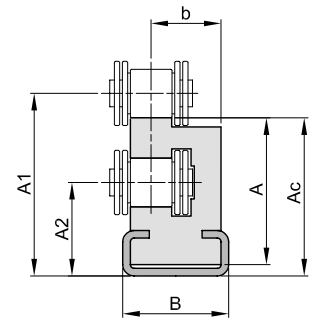

GUIDACATENA PREDISPOSTA PER PROFILO METALLICO DA ORDINARE SEPARATAMENTE

PROFILI METALLICI - ZINCATI - lunghezza 2 metri

tipo	codice	A	B	C	S	Kg./Mt.
C3	6011180003	10	20	10	1,5	0,46
C5	6011180005	12	28	14	1,5	0,64
C9	6011180009	18	38	22	1,5	0,93
C10	6011180010	24	30	20	1,5	0,89
C11	6011180011	40	45	31	2	1,96

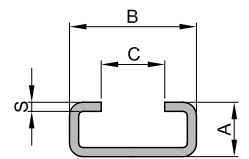

PROFILI METALLICI - INOX - lunghezza 2 metri

tipo	codice	A	B	C	S	Kg./Mt.
C3	6011190003	10	20	10	1,5	0,46
C5	6011190005	12	28	14	1,5	0,64
C9	6011190009	18	38	22	1,5	0,93
C10	6011190010	24	30	20	1,5	0,89

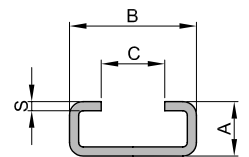

CARATTERISTICHE TECNICHE POLIETILENE

MATERIALE : PE UHMW Polietilene ad altissima densità.

PESO SPECIFICO : 0,94 gr/cm³

DUREZZA : Shore D 64/67

TEMPERATURA D'IMPIEGO : Fino a 80° C

COEFFICIENTE DI DILATAZIONE TERMICA : mm/° c 2 x 10-4

(2 mm/mt per ogni 10° C)



SMONTACATENA CHAIN DETACHER

Gli smontacatena universali vengono utilizzati per il frazionamento della catena.
Si dividono in tre tipologie ed ognuna è utilizzata per gamme di passi diversi

Es.: Smontacatena tipo 1 utilizzabile dal passo 6 al passo 3/4"

The universal chain detacher are used for splitting the chain.
They are divided into three types and each one is used for different pitch ranges

Ex.: Chain detacher type 1 is used from chain pitch 6 to 3/4"



Descrizione	codice	ISO		Passo		Kg.
		da	a	da	a	
Tipo 1	BKC000001	04	12B	P.6	3/4" x 7/16"	0,31
Tipo 3	BKC000003	16B	20B	1" x 17,02	1"1/4 x 3/4"	0,67
Tipo 5	BKC000005	24B	32B	1"1/2 x 1"	2" x 1"1/4	3,20



TENDITORE PER MONTAGGIO CATENA CHAIN CONNECTING TOOL

I tenditori per montaggio catena universali vengono utilizzati per la giunzione della catena.
Si dividono in tre tipologie ed ognuna è utilizzata per gamme di passi diversi

Es.: Tenditore per montaggio catena tipo 7 utilizzabile dal passo 6 al passo 3/4"

The universal chain connecting tools are used for joining the chain.
They are divided into three types and each one is used for different pitch ranges

Ex.: Chain connecting tool type 7 is used from chain pitch 6 to 3/4"



Descrizione	codice	ISO		Passo		Kg.
		da	a	da	a	
Tipo 7	BKC000007	04	12B	P.6	3/4" x 7/16"	0,19
Tipo 9	BKC000009	16B	20B	1" x 17,02	1"1/4 x 3/4"	0,48
Tipo 11	BKC000011	24B	48B	1"1/2 x 1"	3" x 1"3/4	0,81

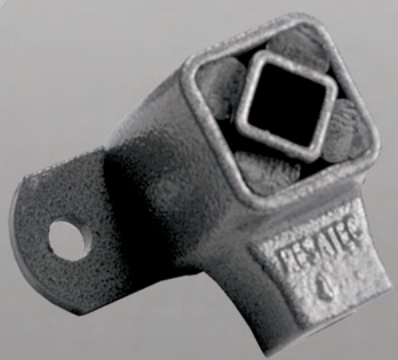
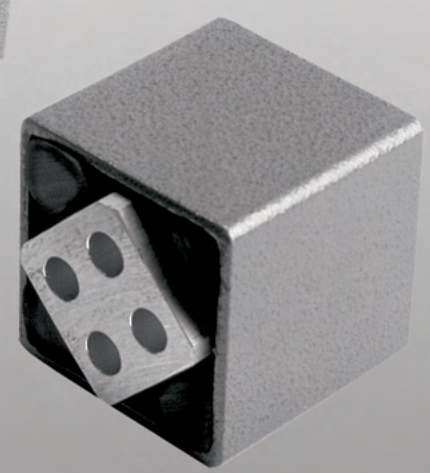
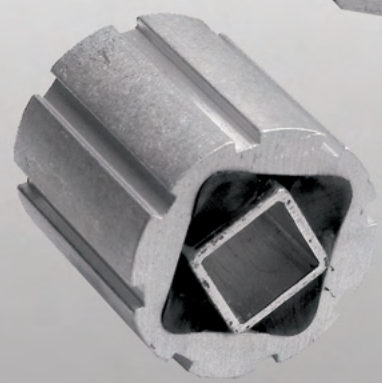
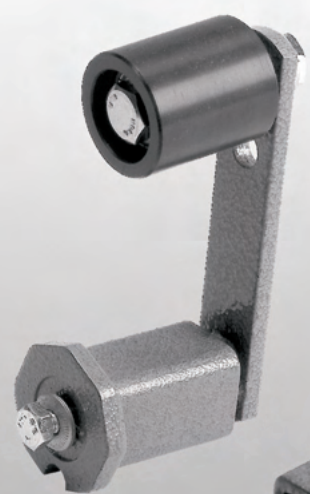
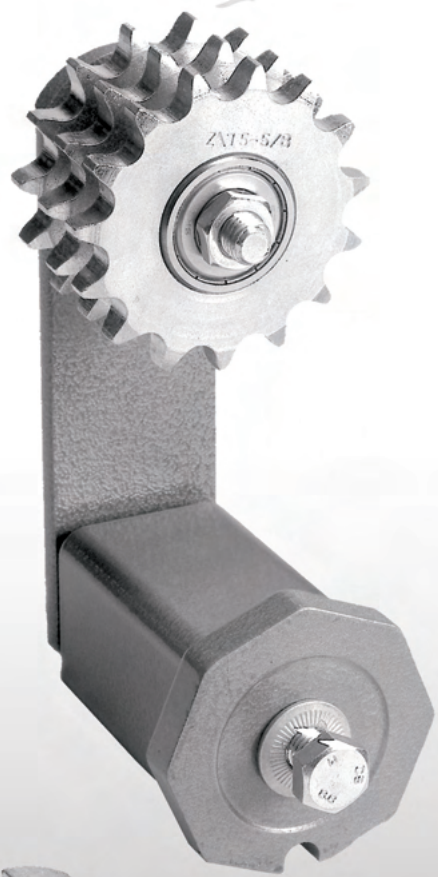

Caratteristiche del sistema elastico universale
Characteristics of the rubber suspension units

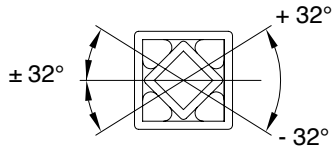

Ampio angolo d'azione
Large operating angle

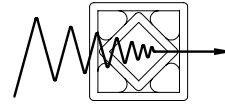

Riduzione di rumore e vibrazioni
Noise and vibration damping

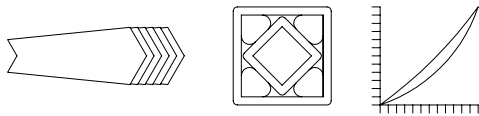

Progressiva elasticità
Progressive spring characteristics

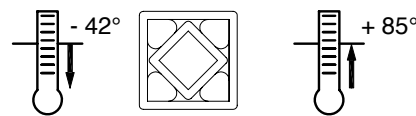

Resistenza alle temperature
Resistant to temperature

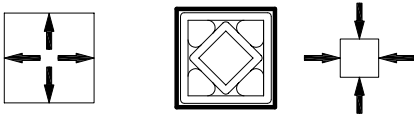

Sicurezza dell'utilizzo
Safe use in any position



Non necessita di manutenzione
Maintenance free

Istruzioni per il corretto montaggio del tendicatena (TEKS) e dei tendicinghia (TERE)

Instructions for a proper mounting of the chain tensioner (TEKS) and of the belt tensioner (TERE)

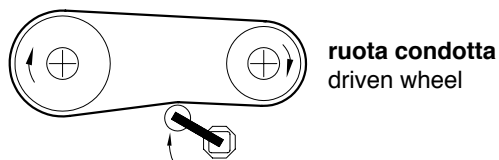

Tenditore sul lato lasco
Tensioner on the loose side

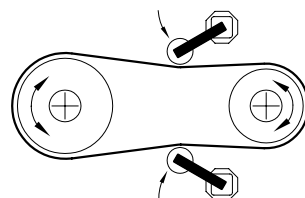

Con motore reversibile montare 2 tendicatena
With reversible engine mount 2 tensioners

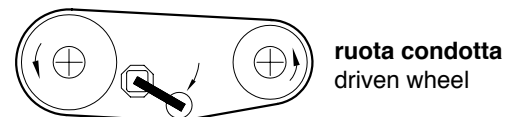

Montaggio con trasmissione a cinghia con profilo a V
Mounting with belt transmission with V profile

Caratteristiche della gomma
Characteristics of the rubber

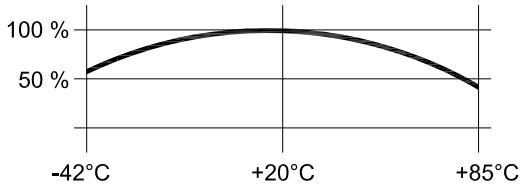

Temperatura ambiente
Room temperature

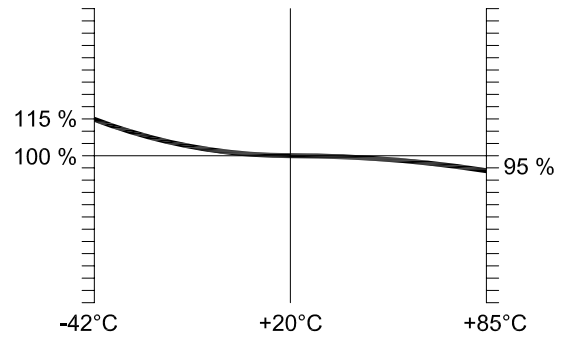

Temperatura ambiente
Room temperature

Durata in condizioni normali di temperatura ~ 10 anni
Temperature influence: service life (under normal conditions) ~ 10 years

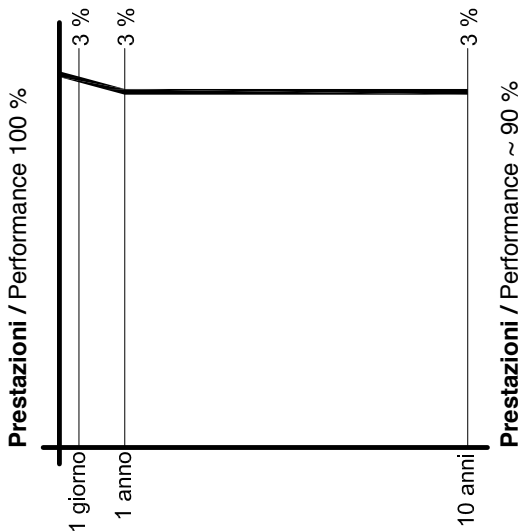

Deformazioni e assestamento della gomma
Could flow and setting

Influenza della temperatura: coppia di reazione (N/m)
Temperature influence: torque reaction (N/m)

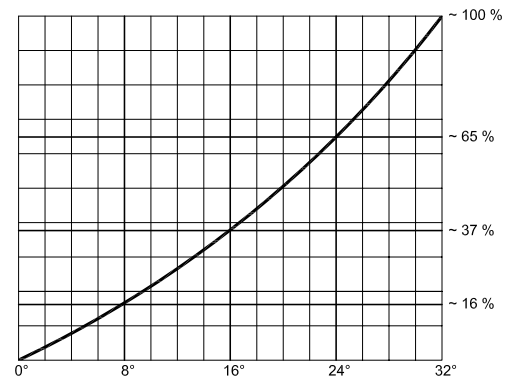

Determinazione della coppia "in percentuale"
Torque determination "in percentage"

Il grafico è applicabile per tutte le dimensioni dei tipi: LTK-S, LTK-A, LTS, LTA

This chart is applicable to all type of: LTK-S, LTK-A, LTS, LTA

Esempio per la determinazione LTS 6-80 con coppia M 215 in Nm a 32° (pag 150)

Example for determinating LTS 6-80 with torque M 215 with Nm a 32° (page 150)

Con angolo di 15° = 35% = ~ 75 Nm

With an angle of 15° = 35% = ~ 75 Nm

Con angolo di 22° = 56% = ~ 120 Nm

With an angle of 22° = 56% = ~ 120 Nm

Con angolo di 28° = 81% = ~ 174 Nm

With an angle of 28° = 81% = ~ 174 Nm



SEMPLICI

descrizione	catena	codice	ISO	denti	A	B	Kg.
TEKS 3	3/8" x 7/32"	6020110330	06B1	15	20 ÷ 50	M10	0,60
TEKS 3	1/2" x 5/16"	6020110340	08B1	15	20 ÷ 50	M10	0,65
TEKS 5	5/8" x 3/8"	6020110350	10B1	15	26 ÷ 67	M12	2,32
TEKS 5	3/4" x 7/16"	6020110360	12B1	15	26 ÷ 67	M12	2,55
TEKS 6	1" x 17,02	6020110380	16B1	13	37 ÷ 102	M20	5,00
TEKS 7	1"1/4 x 3/4"	6020110400	20B1	13	39 ÷ 122	M20	8,55
TEKS 7	1"1/2 x 1"	6020110420	24B1	11	39 ÷ 142	M20	8,90

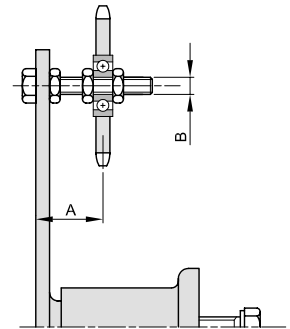

DOPPI

descrizione	catena	codice	ISO	denti	A	B	Kg.
TEKS 3	3/8" x 7/32"	6020120330	06B2	15	25 ÷ 44	M10	0,65
TEKS 4	1/2" x 5/16"	6020120340	08B2	15	27 ÷ 43	M10	1,15
TEKS 5	5/8" x 3/8"	6020120350	10B2	15	34 ÷ 59	M12	2,55
TEKS 5	3/4" x 7/16"	6020120360	12B2	15	36 ÷ 57	M12	3,00
TEKS 6	1" x 17,02	6020120380	16B2	13	52 ÷ 86	M20	5,80
TEKS 7	1"1/4 x 3/4"	6020120400	20B2	13	57 ÷ 104	M20	10,10
TEKS 7	1"1/2 x 1"	6020120420	24B2	11	63 ÷ 118	M20	10,75

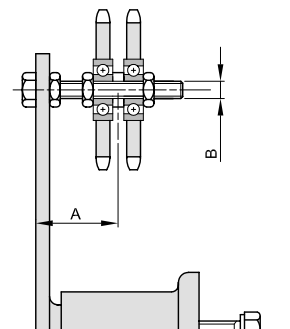

TRIPLI

descrizione	catena	codice	ISO	denti	A	B	Kg.
TEKS 4	3/8" x 7/32"	6020130330	06B3	15	31 ÷ 39	M10	0,95
TEKS 5	1/2" x 5/16"	6020130340	08B3	15	40 ÷ 53	M12	2,45
TEKS 6	5/8" x 3/8"	6020130350	10B3	15	53 ÷ 85	M20	4,95
TEKS 6	3/4" x 7/16"	6020130360	12B3	15	56 ÷ 83	M20	5,20
TEKS 7	1" x 17,02	6020130380	16B3	13	70 ÷ 70	M20	9,40
TEKS 7	1"1/4 x 3/4"	6020130400	20B3	13	75 ÷ 86	M20	11,70
TEKS 7	1"1/2 x 1"	6020130420	24B3	11	87 ÷ 94	M20	12,70

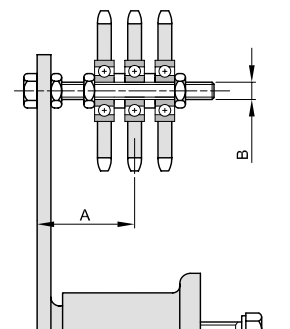



TENDICATENA UNIVERSALI TIPO "TECRS" UNIVERSAL CHAIN TENSIONERS TYPE "TECRS"



SEMPLICI

descrizione	catena	codice	ISO	A	B	Kg.
TECRS 2	3/8" x 7/32"	6020210330	06B1	18 ÷ 35	M8	0,30
TECRS 3	1/2" x 5/16"	6020210340	08B1	23 ÷ 45	M10	0,56
TECRS 4	5/8" x 3/8"	6020210350	10B1	24 ÷ 44	M10	0,82
TECRS 5	3/4" x 7/16"	6020210360	12B1	30 ÷ 60	M12	2,17

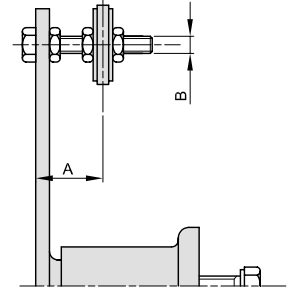

DOPPI

descrizione	catena	codice	ISO	A	B	Kg.
TECRS 2	3/8" x 7/32"	6020220330	06B2	25 ÷ 30	M8	0,32
TECRS 3	1/2" x 5/16"	6020220340	08B2	30 ÷ 34	M10	0,60
TECRS 4	5/8" x 3/8"	6020220350	10B2	34 ÷ 46	M10	0,90
TECRS 5	3/4" x 7/16"	6020220360	12B2	40 ÷ 52	M12	2,31

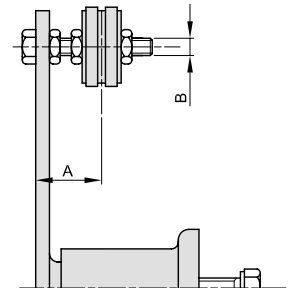

TENDICINGHIA UNIVERSALI TIPO "TERE" UNIVERSAL BELT TENSIONERS TYPE "TERE"



descrizione	codice	A	B	C	Ø D	E	Kg.
TERE 2	6020300301	61	43	80	30	35	0,32
TERE 3	6020300401	70	56	100	40	45	0,62
TERE 4	6020300402	88	57	100	40	45	0,85
TERE 5	6020300601	122	76	130	60	60	2,34
TERE 6	6020300801	158	109	175	80	90	4,90
TERE 7	6020300802	211	154	220	80	135	8,20

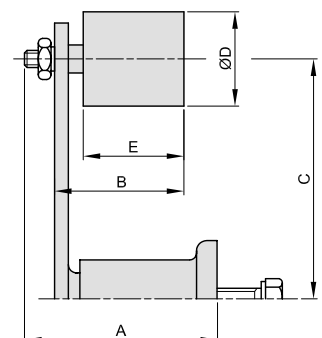



ELEMENTI TENDITORI UNIVERSALI TIPO "TE" UNIVERSAL TENSIONERS TYPE "TE"

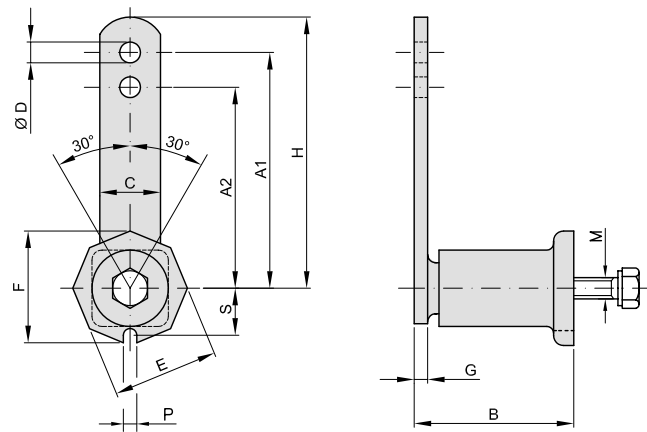

descrizione	codice	A1	A2	B	C	Ø D	E	F	G	H	Forza max in N		M	P	S	Kg.	
											Torque in N Δ 0 - 32°	Torque in N Δ 0 - 32°					
												A1	A2				
TE 2	6021000020	80	60	52	20	8,5	35	38	5	90	0 - 90	0 - 110	M 6	8	16,5	0,25	
TE 3	6021000030	100	80	63	25	10,5	46	48	5	115	0 - 140	0 - 170	M 8	8,5	19,5	0,45	
TE 4	6021000040	100	80	78	30	10,5	56	60	6	115	0 - 320	0 - 430	M10	8,5	24,5	0,68	
TE 5	6021000050	130	100	108	50	12,5	72	78	8	155	0 - 820	0 - 1050	M12	10,5	34	1,70	
TE 6	6021000060	175	140	145	60	20,5	93	100	10	205	0 - 1500	0 - 1880	M16	12,5	42	3,70	
TE 7	6021000070	220	175	198	70	20,5	106	114	12	255	0 - 2500	0 - 3200	M20	12,5	50	6,50	

descrizione	codice	A1	A2	B	C	Ø D	E	F	G	H	Forza max in N		M	P	S	Kg.	
											Torque in N Δ 0 - 32°	Torque in N Δ 0 - 32°					
												A1	A2				
TE 2 - INOX	6021000120	80	60	52	20	8,5	35	38	5	90	0 - 90	0 - 110	M 6	8	16,5	0,25	
TE 3 - INOX	6021000130	100	80	63	25	10,5	46	48	5	115	0 - 140	0 - 170	M 8	8,5	19,5	0,45	
TE 4 - INOX	6021000140	100	80	78	30	10,5	56	60	6	115	0 - 320	0 - 430	M10	8,5	24,5	0,68	
TE 5 - INOX	6021000150	130	100	108	50	12,5	72	78	8	155	0 - 820	0 - 1050	M12	10,5	34	1,70	



PATTINI TENDICATENA TIPO "CRS" CHAINRIDER SET TYPE "CRS"

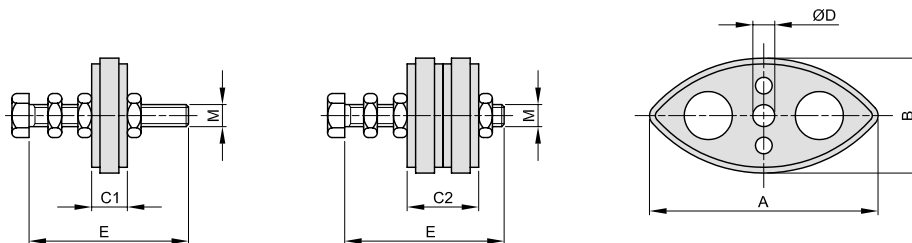

descrizione	catena	codice	ISO	A	B	C1	C2	Ø D	M	E	semplice Kg.	doppio Kg.
CRS 3/8"	3/8" x 7/32"	6023330000	06B	74	40	10,2	20,4	8	M8	45	0,05	0,07
CRS 1/2"	1/2" x 5/16"	6023340000	08B	96	50	13,9	27,8	10	M10	60	0,11	0,15
CRS 5/8"	5/8" x 3/8"	6023350000	10B	125	55	16,5	33,0	10	M10	60	0,14	0,22
CRS 3/4"	3/4" x 7/16"	6023360000	12B	147	80	19,5	39,0	12	M12	80	0,22	0,36



PIGNONI TENDICATENA TIPO "KS" - DIN 8187 SPROCKETS WHEELS TYPE "KS" - DIN 8187

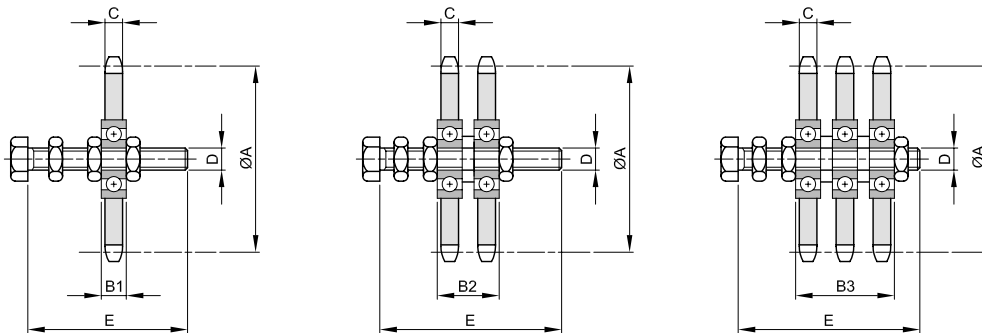

descrizione	codice	ISO	denti	Ø A	B1	B2	B3	C	D	E	semplice Kg.	doppio Kg.	triplo Kg.
KS 3/8" x 7/32"	6022330151	06B-1-2-3	15	45,81	9	19,2	29,4	5,7	M10	60	0,15	0,20	0,25
KS 1/2" x 5/16"	6022340151	08B-1-2	15	61,08	9	22,9		7,2	M10	60	0,20	0,35	
KS 1/2" x 5/16"	6022340152	08B-1-2-3	15	61,08	12	26,0	40,0	7,2	M12	80	0,23	0,45	0,50
KS 5/8" x 3/8"	6022350151	10B-1-2-3	15	76,36	12	28,6	45,2	9,1	M12	80	0,37	0,60	0,95
KS 5/8" x 3/8"	6022350152	10B-1-2-3	15	76,36	15	31,5	48,2	9,1	M20	120	0,70	1,00	1,25
KS 3/4" x 7/16"	6022360151	12B-1-2	15	91,63	12	31,5		11,5	M12	80	0,60	1,05	
KS 3/4" x 7/16"	6022360152	12B-1-2-3	15	91,63	15	34,5	54,0	11,5	M20	120	0,90	1,35	1,50
KS 1" x 17,02	6022380131	16B-1-2-3	13	106,14	15	46,9	78,8	16,2	M20	120	1,30	2,10	2,90
KS 1 1/4" x 3/4"	6022400131	20B-1-2-3	13	132,67	15	51,5	88,0	18,5	M20	140	2,05	3,60	5,20
KS 1 1/2" x 1"	6022420111	24B-1-2-3	11	135,23	15	63,4	111,8	24,1	M20	160	2,40	4,25	6,20



RULLI TENDICINGHIA TIPO "RE" ROLLERSET TYPE "RE"

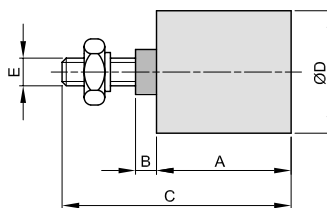

descrizione	codice	A	B	C	Ø D	E	Kg.
RE 2	6023000301	35	3	51	30	M8	0,07
RE 3	6023000401	45	6	67	40	M10	0,17
RE 4	6023000401	45	6	67	40	M10	0,17
RE 5	6023000601	60	7,5	89	60	M12	0,39
RE 6	6023000801	90	9	127	80	M20	1,20
RE 7	6023000802	135	7	167	80	M20	1,70



ELEMENTI OSCILLANTI TIPO "OM" OSCILLANTING MOUNTING TYPE "OM"

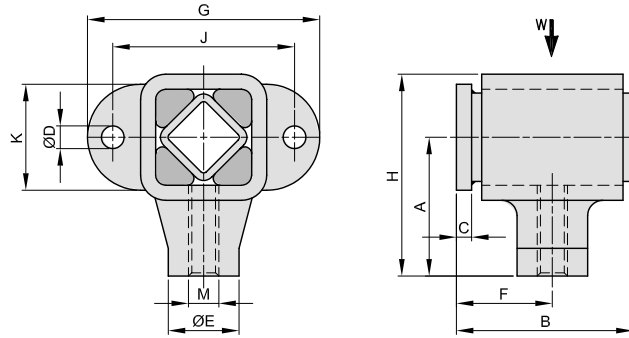

descrizione	codice	A	B	C	Ø D	E	F	G	H	J	K	M	W carico max in N	Fr Freq. max in min ⁻¹	Kg.
OM 4 R	6024000041	40	61	5	9	24	33	82	58	60	30	M12 R	190	1250	0,28
OM 4 L	6024000042	40	61	5	9	24	33	82	58	60	30	M12 L	190	1250	0,28
OM 5 R	6024000051	55	75	6	11	30	41	108	81	80	45	M16 R	380	780	0,58
OM 5 L	6024000052	55	75	6	11	30	41	108	81	80	45	M16 L	380	780	0,58
OM 6 R	6024000061	80	98	8	13	40	53	130	115	100	60	M20 R	780	760	1,45
OM 6 L	6024000062	80	98	8	13	40	53	130	115	100	60	M20 L	780	760	1,45
OM 7 R	6024000071	90	118	8	17	50	63	170	135	130	70	M24 R	1550	750	2,54
OM 7 L	6024000072	90	118	8	17	50	63	170	135	130	70	M24 L	1550	750	2,54
OM 8 R	6024000081	100	140	10	17	60	75	180	147	140	80	M36 R	2400	580	6,05
OM 8 L	6024000082	100	140	10	17	60	75	180	147	140	80	M36 L	2400	580	6,05



TESTE DI BIELLA TIPO "DH" CRANKDRIVE UNIT TYPE "DH"

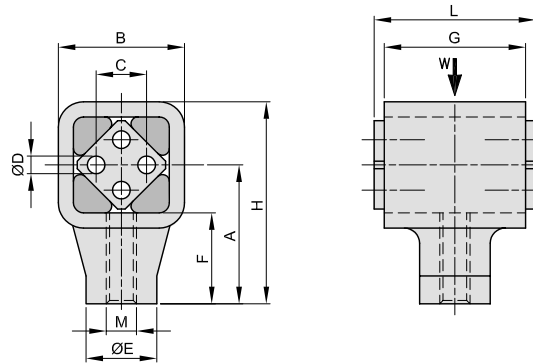

descrizione	codice	A	B	C	Ø D	E	F	G	H	L	M	W forza accel. in N	ne Vel. di rotaz. in min ⁻¹	Kg.
DH 4-50 R	6025004501	40	36	12	6	24	25	50	58	55	M12 R	380	1250	0,20
DH 4-50 L	6025004502	40	36	12	6	24	25	50	58	55	M12 L	380	1250	0,20
DH 5-60 R	6025005601	55	52	20	8	30	35	60	81	65	M16 R	960	1200	0,52
DH 5-60 L	6025005602	55	52	20	8	30	35	60	81	65	M16 L	960	1200	0,52
DH 6-80 R	6025006801	80	72	25	10	40	52	80	115	90	M20 R	1900	780	1,48
DH 6-80 L	6025006802	80	72	25	10	40	52	80	115	90	M20 L	1900	780	1,48
DH 7-100 R	6025071001	90	90	35	12	50	55	100	135	110	M24 R	3400	750	2,65
DH 7-100 L	6025071002	90	90	35	12	50	55	100	135	110	M24 L	3400	750	2,65
DH 8-120 R	6025081201	100	94	40	M12x30	60	64	120	147	130	M36 R	5800	580	6,30
DH 8-120 L	6025081202	100	94	40	M12x30	60	64	120	147	130	M36 L	5800	580	6,30
DH 9-200 R	6025092001	120	120	45	M16x25	80	75	200	180	210	M42 R	11500	330	17,70
DH 9-200 L	6025092002	120	120	45	M16x25	80	75	200	180	210	M42 L	11500	330	17,70
DH 9-300 R	6025093001	120	120	45	M16x25	80	75	300	180	310	M42 R	17500	300	26,50
DH 9-300 L	6025093002	120	120	45	M16x25	80	75	300	180	310	M42 L	17500	300	26,50



ELEMENTI ELASTICI TIPO "LTK-S" RUBBER SUSPENSION UNIT TYPE "LTK-S"

RESATEC
CERTIFICATA ISO 9001

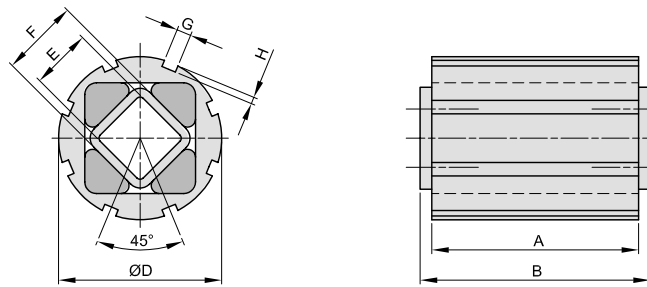

descrizione	codice	Coppia M in Nm a 32° Torque M in Nm at 32°	A	B	Ø D	E	F	G	H	Kg.
LTK-S 5-40	6029005040	56	40	45	62	22	27	6	3	0,30
LTK-S 5-60	6029005060	85	60	65	62	22	27	6	3	0,40
LTK-S 5-100	6029005100	140	100	105	62	22	27	6	3	0,65
LTK-S 6-60	6029006060	160	60	70	80	30	38	7	3,5	0,70
LTK-S 6-80	6029006080	215	80	90	80	30	38	7	3,5	0,90
LTK-S 6-120	6029006120	320	120	130	80	30	38	7	3,5	1,30



ELEMENTI ELASTICI TIPO "LTK-A" RUBBER SUSPENSION UNIT TYPE "LTK-A"

RESATEC
CERTIFICATA ISO 9001

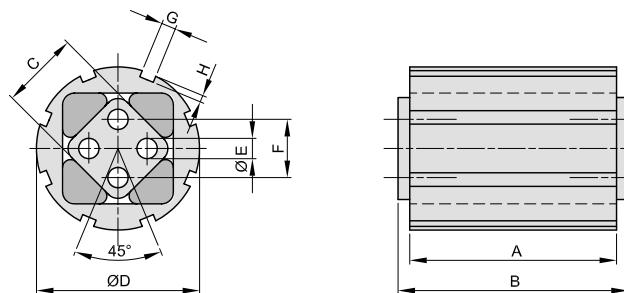

descrizione	codice	Coppia M in Nm a 32° Torque M in Nm at 32°	A	B	C	Ø D	Ø E	F	G	H	Kg.
LTK-A 5-40	6030005040	56	40	45	27	62	8	20	6	3	0,25
LTK-A 5-60	6030005060	85	60	65	27	62	8	20	6	3	0,35
LTK-A 5-100	6030005100	140	100	105	27	62	8	20	6	3	0,60
LTK-A 6-60	6030006060	160	60	70	38	80	10	25	7	3,5	0,60
LTK-A 6-80	6030006080	215	80	90	38	80	10	25	7	3,5	0,80
LTK-A 6-120	6030006120	320	120	130	38	80	10	25	7	3,5	1,20



ELEMENTI ELASTICI TIPO "LTS" RUBBER SUSPENSION UNIT TYPE "LTS"

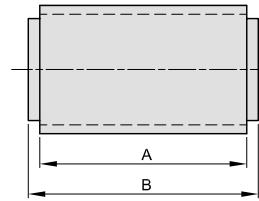
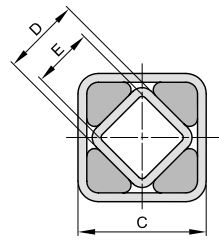

descrizione	codice	Coppia M in Nm a 32° Torque M in Nm at 32°	A	B	C	D	E	Kg.
LTS 3-25	6027003025	8	25	30	27	15	11	0,08
LTS 3-40	6027003040	13	40	45	27	15	11	0,13
LTS 3-60	6027003060	19	60	65	27	15	11	0,19
LTS 4-30	6027004030	20	30	35	32	18	12	0,13
LTS 4-50	6027004050	34	50	55	32	18	12	0,22
LTS 4-80	6027004080	54	80	85	32	18	12	0,33
LTS 5-40	6027005040	56	40	45	45	27	22	0,27
LTS 5-60	6027005060	85	60	65	45	27	22	0,40
LTS 5-100	6027005100	140	100	105	45	27	22	0,66
LTS 6-60	6027006060	160	60	70	60	38	30	0,68
LTS 6-80	6027006080	215	80	90	60	38	30	0,90
LTS 6-120	6027006120	320	120	130	60	38	30	1,35
LTS 7-80	6027007080	315	80	90	72	45	35	1,20
LTS 7-100	6027007100	390	100	110	72	45	35	1,46
LTS 7-150	6027007150	580	150	160	72	45	35	2,16
LTS 8-120	6027008120	720	120	130	80	50	40	2,20
LTS 8-200	6027008200	1300	200	210	80	50	40	3,50
LTS 8-300	6027008300	2000	300	310	80	50	40	5,30



ELEMENTI ELASTICI TIPO "LTA" RUBBER SUSPENSION UNIT TYPE "LTA"

RESATEC
CERTIFICATA ISO 9001

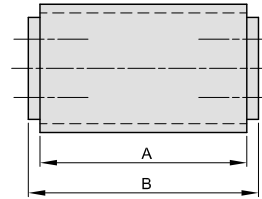
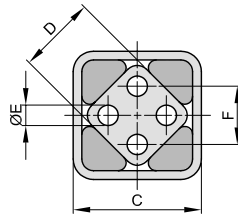

descrizione	codice	Coppia M in Nm a 32° Torque M in Nm at 32°	A	B	C	D	Ø E	F	Kg.
LTA 4-30	6028004030	20	30	35	32	18	6	12	0,10
LTA 4-50	6028004050	34	50	55	32	18	6	12	0,15
LTA 4-80	6028004080	54	80	85	32	18	6	12	0,26
LTA 5-40	6028005040	56	40	45	45	27	8	20	0,26
LTA 5-60	6028005060	85	60	65	45	27	8	20	0,37
LTA 5-100	6028005100	140	100	105	45	27	8	20	0,62
LTA 6-60	6028006060	160	60	70	60	38	10	25	0,61
LTA 6-80	6028006080	215	80	90	60	38	10	25	0,80
LTA 6-120	6028006120	320	120	130	60	38	10	25	1,15
LTA 7-80	6028007080	315	80	90	72	45	12	35	1,01
LTA 7-100	6028007100	390	100	110	72	45	12	35	3,00
LTA 7-150	6028007150	580	150	160	72	45	12	35	4,45
LTA 8-120	6028008120	760	120	130	80	50	M12x40	40	1,85
LTA 8-200	6028008200	1370	200	210	80	50	M12x40	40	3,02
LTA 8-300	6028008300	2050	300	310	80	50	M12x40	40	4,48



ELEMENTI OSCILLANTI TIPO "HC" OSCILLANTING-MOUNTINGS TYPE "HC"

RESATEC
CERTIFICATA ISO 9001

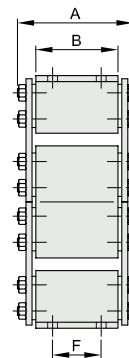
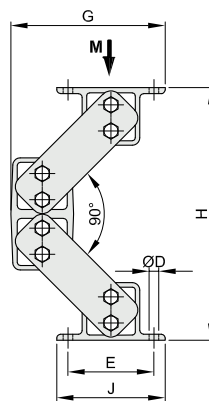

descrizione	codice	A	B	Ø D	E	F	G	G max	H	H min	J	CARICO LAOD M in N	Kg.
HC 6	6023500006	106	80	13	100	40	184	211	305	224	125	600 - 1600	6,90
HC 7	6023500007	155	110	13	115	65	206	235	333	245	145	1300 - 3300	13,50
HC 8	6023500008	172	120	17	130	60	230	263	366	264	170	2400 - 5800	20,50



SUPPORTI TIPO "MA" MOUNTING SUPPORT TYPE "MA"

RESATEC
CERTIFICATA ISO 9001

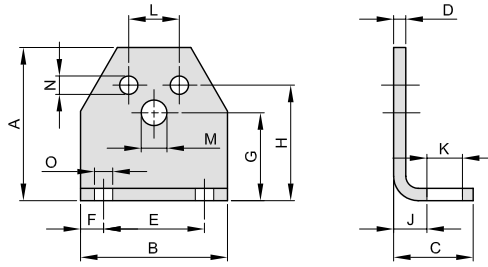

descrizione	codice	adatto a tipo		A	B	C	D	E	F	G	H	J	K	L	M	N	O	Kg.
		TE...	LT...															
MA 2	6031000002	2	3	46	50	30	4	30	10	27	35	12	13	10	6,5	5,5	7	0,09
MA 3	6031000003	3	4	58	60	32	6	40	10	34	44	14	13	12	8,5	6,5	7	0,19
MA 4	6031000004	4	5	75	70	38	6	50	10	45	55	16	16	20	10,5	8,5	9,5	0,30
MA 5	6031000005	5	6	98	90	52	8	65	12,5	58	75	21	22	25	12,5	10,5	11,5	0,70
MA 6	6031000006	6	7	116	110	55	8	80	15	66	85	21	24	35	16,5	12,5	14	0,90
MA 7	6031000007	7	8	140	140	66	10	100	20	80	110	26	30	40	20,5	12,5	18	1,80



STAFFE TIPO "CK" MOUNTING CLAMP TYPE "CK"

RESATEC
CERTIFICATA ISO 9001

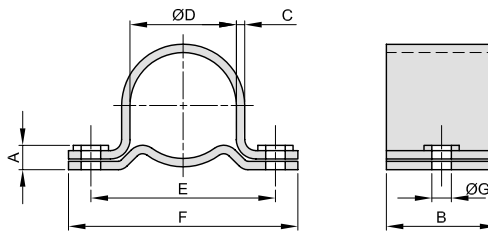

descrizione	codice	A	B	C	Ø D	E	F	Ø G	Kg.
CK 5	6032000005	10	40	3	62	92	125	10,5	0,30
CK 6	6032000006	11	40	3	80	115	150	12,5	0,45



STAFFE TIPO "MS" MOUNTING CLAMP TYPE "MS"

RESATEC
CERTIFICATA ISO 9001

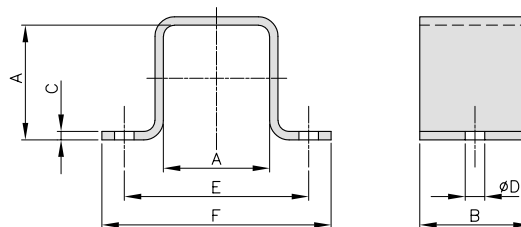

descrizione	codice	A	B	C	Ø D	E	F	Kg.
MS 3	6033000003	27	25	2	6,5	50	65	0,04
MS 4	6033000004	32	30	3	8,5	60	80	0,09
MS 5	6033000005	45	35	3	10,5	80	105	0,16
MS 6	6033000006	60	40	5	12,5	100	125	0,29
MS 7	6033000007	72	45	5	12,5	115	145	0,45
MS 8	6033000008	80	50	6	17	130	170	0,68

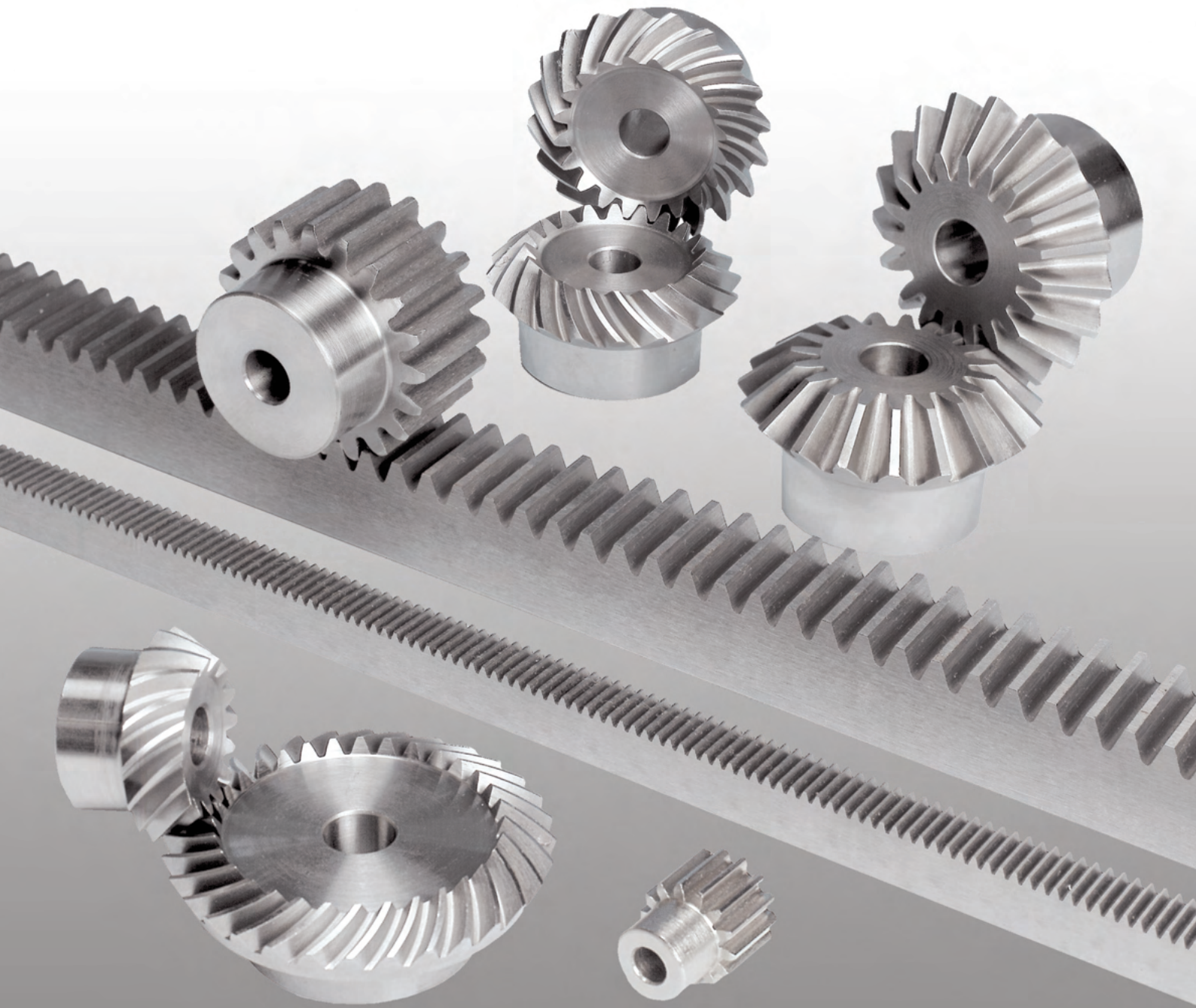



RUOTE DENTATE CILINDRICHE CYLINDRICAL GEARS

MODULO 1

ANGOLO DI PRESSIONE 20°

A	B
25	15

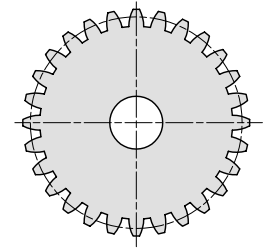
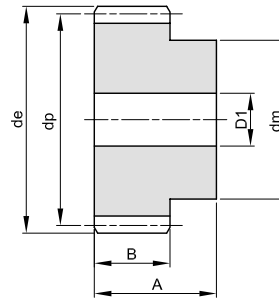
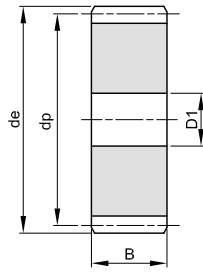

Materiale: Acciaio C45

Z	codice	de	dp	dm	D1	Kg.
12	401010012	14	12	9	-	0,01
13	401010013	15	13	10	-	0,02
14	401010014	16	14	11	-	0,02
15	401010015	17	15	12	-	0,02
16	401010016	18	16	13	-	0,03
17	401010017	19	17	14	-	0,03
18	401010018	20	18	15	8	0,03
19	401010019	21	19	15	8	0,04
20	401010020	22	20	16	8	0,04
21	401010021	23	21	16	8	0,05
22	401010022	24	22	16	8	0,05
23	401010023	25	23	18	8	0,06
24	401010024	26	24	20	10	0,06
25	401010025	27	25	20	10	0,07
26	401010026	28	26	20	10	0,07
27	401010027	29	27	20	10	0,08
28	401010028	30	28	20	10	0,08
29	401010029	31	29	20	10	0,09
30	401010030	32	30	20	10	0,09
31	401010031	33	31	25	10	0,11
32	401010032	34	32	25	10	0,12
33	401010033	35	33	25	10	0,12
34	401010034	36	34	25	10	0,13
35	401010035	37	35	25	10	0,14
36	401010036	38	36	25	10	0,14
37	401010037	39	37	25	10	0,15
38	401010038	40	38	25	10	0,16
39	401010039	41	39	25	10	0,16
40	401010040	42	40	25	10	0,17
41	401010041	43	41	30	10	0,19
42	401010042	44	42	30	10	0,20
43	401010043	45	43	30	10	0,21
44	401010044	46	44	30	10	0,22
45	401010045	47	45	30	10	0,23
46	401010046	48	46	30	10	0,23
47	401010047	49	47	30	10	0,24
48	401010048	50	48	30	10	0,25
49	401010049	51	49	30	10	0,26
50	401010050	52	50	30	12	0,26
51	401010051	53	51	40	12	0,32
52	401010052	54	52	40	12	0,33
53	401010053	55	53	40	12	0,33
54	401010054	56	54	40	12	0,34

Z	codice	de	dp	dm	D1	Kg.
55	401010055	57	55	40	12	0,36
56	401010056	58	56	40	12	0,37
57	401010057	59	57	40	12	0,38
58	401010058	60	58	40	12	0,39
59	401010059	61	59	40	12	0,40
60	401010060	62	60	40	12	0,41
61	401010061	63	61	50	12	0,47
62	401010062	64	62	50	12	0,49
63	401010063	65	63	50	12	0,50
64	401010064	66	64	50	12	0,51
65	401010065	67	65	50	12	0,52
66	401010066	68	66	50	12	0,53
67	401010067	69	67	50	12	0,55
68	401010068	70	68	50	12	0,56
69	401010069	71	69	50	12	0,57
70	401010070	72	70	50	12	0,58
72	411010072	74	72		12	0,46
75	411010075	77	75		12	0,51
76	411010076	78	76		12	0,52
80	411010080	82	80		12	0,58
85	411010085	87	85		12	0,65
90	411010090	92	90		12	0,73
95	411010095	97	95		12	0,82
100	411010100	102	100		12	0,91
110	411010110	112	110		12	1,10
114	411010114	116	114		12	1,19
120	411010120	122	120		12	1,32
127	411010127	129	127		12	1,47



RUOTE DENTATE CILINDRICHE CYLINDRICAL GEARS

MODULO 1,5

ANGOLO DI PRESSIONE 20°

A	B
30	17

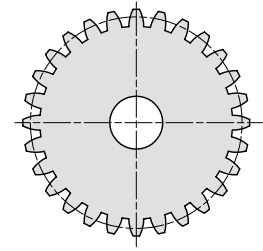
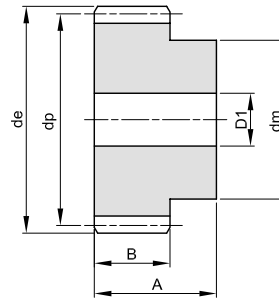
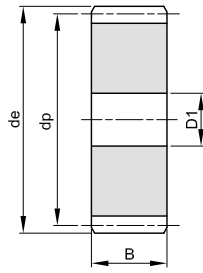

Materiale: Acciaio C45

Z	codice	de	dp	dm	D1	Kg.
12	401015012	21,0	18,0	14	8	0,04
13	401015013	22,5	19,5	15	8	0,05
14	401015014	24,0	21,0	17	8	0,06
15	401015015	25,5	22,5	18	8	0,07
16	401015016	27,0	24,0	19	8	0,08
17	401015017	28,5	25,5	20	8	0,09
18	401015018	30,0	27,0	20	8	0,10
19	401015019	31,5	28,5	20	8	0,10
20	401015020	33,0	30,0	25	8	0,13
21	401015021	34,5	31,5	25	10	0,13
22	401015022	36,0	33,0	25	10	0,14
23	401015023	37,5	34,5	25	10	0,16
24	401015024	39,0	36,0	25	10	0,17
25	401015025	40,5	37,5	25	10	0,18
26	401015026	42,0	39,0	30	12	0,20
27	401015027	43,5	40,5	30	12	0,22
28	401015028	45,0	42,0	30	12	0,23
29	401015029	46,5	43,5	30	12	0,24
30	401015030	48,0	45,0	30	12	0,26
31	401015031	49,5	46,5	35	12	0,30
32	401015032	51,0	48,0	35	12	0,31
33	401015033	52,5	49,5	35	12	0,33
34	401015034	54,0	51,0	35	12	0,34
35	401015035	55,5	52,5	35	12	0,36
36	401015036	57,0	54,0	35	12	0,37
37	401015037	58,5	55,5	40	12	0,42
38	401015038	60,0	57,0	40	12	0,44
39	401015039	61,5	58,5	40	12	0,46
40	401015040	63,0	60,0	40	12	0,48
41	401015041	64,5	61,5	40	12	0,50
42	401015042	66,0	63,0	50	12	0,59
43	401015043	67,5	64,5	50	12	0,61
44	401015044	69,0	66,0	50	12	0,63
45	401015045	70,5	67,5	50	12	0,65
46	401015046	72,0	69,0	50	14	0,66
47	401015047	73,5	70,5	50	14	0,70
48	401015048	75,0	72,0	50	14	0,70
49	401015049	76,5	73,5	50	14	0,73
50	401015050	78,0	75,0	50	14	0,76
51	401015051	79,5	76,5	60	14	0,86
52	401015052	81,0	78,0	60	14	0,89
53	401015053	82,5	79,5	60	14	0,91
54	401015054	84,0	81,0	60	14	0,94

Z	codice	de	dp	dm	D1	Kg.
55	401015055	85,5	82,5	60	14	0,96
56	401015056	87,0	84,0	60	16	0,98
57	401015057	88,5	85,5	60	16	1,00
58	401015058	90,0	87,0	60	16	1,03
59	401015059	91,5	88,5	60	16	1,05
60	401015060	93,0	90,0	60	16	1,09
61	401015061	94,5	91,5	70	16	1,22
62	401015062	96,0	93,0	70	16	1,25
63	401015063	97,5	94,5	70	16	1,28
64	401015064	99,0	96,0	70	16	1,31
65	401015065	100,5	97,5	70	16	1,34
66	401015066	102,0	99,0	70	16	1,37
67	401015067	103,5	100,5	70	16	1,40
68	401015068	105,0	102,0	70	16	1,43
69	401015069	106,5	103,5	70	16	1,46
70	401015070	108,0	105,0	70	16	1,50
72	411015072	111,0	108,0		16	1,19
75	411015075	115,5	112,5		16	1,30
76	411015076	117,0	114,0		16	1,33
80	411015080	123,0	120,0		16	1,48
85	411015085	130,5	127,5		16	1,67
90	411015090	138,0	135,0		16	1,88
95	411015095	145,5	142,5		16	2,09
100	411015100	153,0	150,0		16	2,32
110	411015110	168,0	165,0		16	2,82
114	411015114	174,0	171,0		16	3,03
120	411015120	183,0	180,0		16	3,36
127	411015127	193,5	190,5		16	3,77



RUOTE DENTATE CILINDRICHE CYLINDRICAL GEARS

MODULO 2

ANGOLO DI PRESSIONE **20°**

A	B
35	20

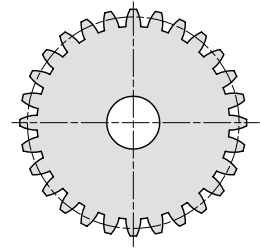
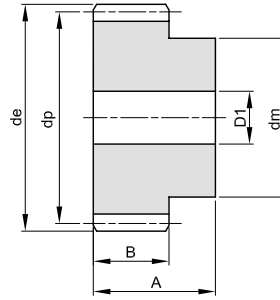
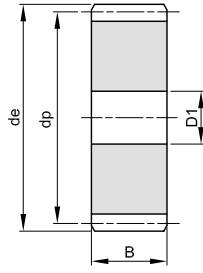

Materiale: Acciaio C45

Z	codice	de	dp	dm	D1	Kg.
12	401020012	28	24	18	10	0,08
13	401020013	30	26	20	10	0,10
14	401020014	32	28	22	10	0,12
15	401020015	34	30	24	10	0,14
16	401020016	36	32	25	10	0,16
17	401020017	38	34	25	10	0,18
18	401020018	40	36	25	10	0,19
19	401020019	42	38	25	10	0,21
20	401020020	44	40	30	10	0,26
21	401020021	46	42	30	12	0,27
22	401020022	48	44	30	12	0,29
23	401020023	50	46	30	12	0,31
24	401020024	52	48	35	12	0,36
25	401020025	54	50	35	12	0,39
26	401020026	56	52	40	12	0,45
27	401020027	58	54	40	12	0,47
28	401020028	60	56	40	12	0,50
29	401020029	62	58	40	14	0,52
30	401020030	64	60	40	14	0,55
31	401020031	66	62	45	14	0,61
32	401020032	68	64	45	14	0,65
33	401020033	70	66	45	14	0,68
34	401020034	72	68	45	14	0,71
35	401020035	74	70	45	14	0,74
36	401020036	76	72	45	14	0,78
37	401020037	78	74	50	14	0,86
38	401020038	80	76	50	14	0,90
39	401020039	82	78	50	14	0,93
40	401020040	84	80	50	14	0,97
41	401020041	86	82	55	16	1,05
42	401020042	88	84	55	16	1,09
43	401020043	90	86	55	16	1,13
44	401020044	92	88	60	16	1,23
45	401020045	94	90	60	16	1,27
46	401020046	96	92	60	16	1,31
47	401020047	98	94	70	16	1,48
48	401020048	100	96	70	16	1,53
49	401020049	102	98	70	16	1,57
50	401020050	104	100	70	16	1,62
51	401020051	106	102	70	16	1,67
52	401020052	108	104	70	16	1,72
53	401020053	110	106	70	16	1,78
54	401020054	112	108	70	16	1,83

Z	codice	de	dp	dm	D1	Kg.
55	401020055	114	110	70	16	1,88
56	401020056	116	112	70	16	1,94
57	401020057	118	114	70	16	1,99
58	401020058	120	116	70	16	2,05
59	401020059	122	118	70	16	2,11
60	401020060	124	120	70	16	2,16
61	401020061	126	122	80	16	2,36
62	401020062	128	124	80	16	2,42
63	401020063	130	126	80	16	2,48
64	401020064	132	128	80	16	2,55
65	401020065	134	130	80	16	2,61
66	401020066	136	132	80	16	2,67
67	401020067	138	134	80	16	2,74
68	401020068	140	136	80	16	2,81
69	401020069	142	138	80	16	2,87
70	401020070	144	140	80	16	2,94
72	411020072	148	144		16	2,50
75	411020075	154	150		20	2,71
76	411020076	156	152		20	2,79
80	411020080	164	160		20	3,09
85	411020085	174	170		20	3,50
90	411020090	184	180		20	3,93
95	411020095	194	190		20	4,39
100	411020100	204	200		20	4,87
110	411020110	224	220		20	5,90
114	411020114	232	228		20	6,34
120	411020120	244	240		20	7,03
127	411020127	258	254		20	7,89



RUOTE DENTATE CILINDRICHE CYLINDRICAL GEARS

MODULO 2,5

ANGOLO DI PRESSIONE 20°

A	B
45	25

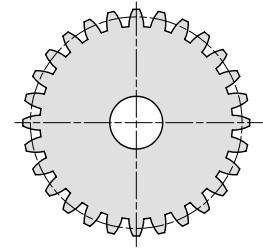
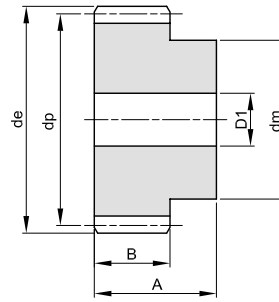
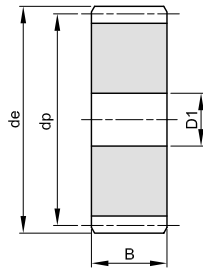

Materiale: Acciaio C45

Z	codice	de	dp	dm	D1	Kg.
12	401025012	35,0	30,0	22	10	0,17
13	401025013	37,5	32,5	25	10	0,21
14	401025014	40,0	35,0	28	10	0,25
15	401025015	42,5	37,5	30	10	0,30
16	401025016	45,0	40,0	32	12	0,33
17	401025017	47,5	42,5	35	12	0,38
18	401025018	50,0	45,0	35	12	0,42
19	401025019	52,5	47,5	35	12	0,45
20	401025020	55,0	50,0	40	12	0,54
21	401025021	57,5	52,5	40	14	0,56
22	401025022	60,0	55,0	45	14	0,66
23	401025023	62,5	57,5	45	14	0,70
24	401025024	65,0	60,0	45	14	0,74
25	401025025	67,5	62,5	50	14	0,85
26	401025026	70,0	65,0	50	14	0,90
27	401025027	72,5	67,5	50	14	0,95
28	401025028	75,0	70,0	50	14	1,00
29	401025029	77,5	72,5	50	14	1,06
30	401025030	80,0	75,0	55	14	1,18
31	401025031	82,5	77,5	55	16	1,22
32	401025032	85,0	80,0	55	16	1,28
33	401025033	87,5	82,5	55	16	1,34
34	401025034	90,0	85,0	55	16	1,41
35	401025035	92,5	87,5	60	16	1,54
36	401025036	95,0	90,0	60	16	1,61
37	401025037	97,5	92,5	60	16	1,68
38	401025038	100,0	95,0	60	16	1,75
39	401025039	102,5	97,5	60	16	1,83
40	401025040	105,0	100,0	70	16	2,06
41	401025041	107,5	102,5	70	16	2,14
42	401025042	110,0	105,0	70	16	2,22
43	401025043	112,5	107,5	70	16	2,30
44	401025044	115,0	110,0	70	16	2,38
45	401025045	117,5	112,5	70	16	2,47
46	401025046	120,0	115,0	70	20	2,52
47	401025047	122,5	117,5	80	20	2,80
48	401025048	125,0	120,0	80	20	2,88
49	401025049	127,5	122,5	80	20	2,98
50	401025050	130,0	125,0	80	20	3,07
51	401025051	132,5	127,5	80	20	3,17
52	401025052	135,0	130,0	90	20	3,48
53	401025053	137,5	132,5	90	20	3,58
54	401025054	140,0	135,0	90	20	3,68

Z	codice	de	dp	dm	D1	Kg.
55	401025055	142,5	137,5	90	20	3,78
56	401025056	145,0	140,0	100	20	4,13
57	401025057	147,5	142,5	100	20	4,23
58	401025058	150,0	145,0	100	20	4,34
59	401025059	152,5	147,5	100	20	4,46
60	401025060	155,0	150,0	100	20	4,57
65	411025065	167,5	162,5		20	3,99
70	411025070	180,0	175,0		20	4,64
72	411025072	185,0	180,0		20	4,91
75	411025075	192,5	187,5		20	5,33
76	411025076	195,0	190,0		20	5,48
80	411025080	205,0	200,0		25	6,04
85	411025085	217,5	212,5		25	6,84
90	411025090	230,0	225,0		25	7,68
95	411025095	242,5	237,5		25	8,57
100	411025100	255,0	250,0		25	9,51
110	411025110	280,0	275,0		25	11,53
114	411025114	290,0	285,0		25	12,39
120	411025120	305,0	300,0		25	13,74
127	411025127	322,5	317,5		25	15,40



RUOTE DENTATE CILINDRICHE CYLINDRICAL GEARS

MODULO 3

ANGOLO DI PRESSIONE **20°**

A	B
50	30

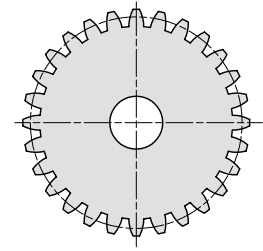
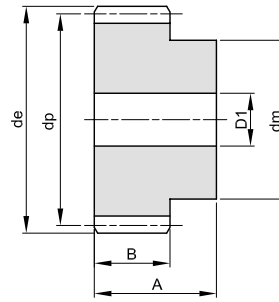
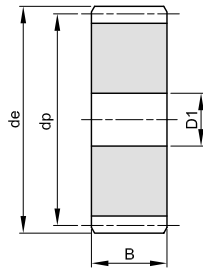

Materiale: Acciaio C45

Z	codice	de	dp	dm	D1	Kg.
12	401030012	42	36	27	12	0,28
13	401030013	45	39	30	12	0,34
14	401030014	48	42	33	12	0,41
15	401030015	51	45	35	12	0,47
16	401030016	54	48	38	14	0,54
17	401030017	57	51	42	14	0,63
18	401030018	60	54	45	14	0,72
19	401030019	63	57	45	14	0,78
20	401030020	66	60	45	14	0,84
21	401030021	69	63	45	16	0,89
22	401030022	72	66	50	16	1,02
23	401030023	75	69	50	16	1,10
24	401030024	78	72	50	16	1,18
25	401030025	81	75	60	16	1,39
26	401030026	84	78	60	16	1,48
27	401030027	87	81	60	16	1,56
28	401030028	90	84	60	16	1,66
29	401030029	93	87	60	16	1,75
30	401030030	96	90	60	16	1,85
31	401030031	99	93	60	16	1,95
32	401030032	102	96	70	16	2,21
33	401030033	105	99	70	16	2,32
34	401030034	108	102	70	16	2,43
35	401030035	111	105	70	16	2,55
36	401030036	114	108	70	20	2,62
37	401030037	117	111	70	20	2,74
38	401030038	120	114	80	20	3,05
39	401030039	123	117	80	20	3,18
40	401030040	126	120	80	20	3,31
41	401030041	129	123	80	20	3,44
42	401030042	132	126	80	20	3,58
43	401030043	135	129	80	20	3,72
44	401030044	138	132	90	20	4,07
45	401030045	141	135	90	20	4,22
46	401030046	144	138	90	20	4,37
47	401030047	147	141	100	20	4,76
48	401030048	150	144	100	20	4,92
50	411030050	156	150		20	4,06
52	411030052	162	156		20	4,40
55	411030055	171	165		20	4,93
57	411030057	177	171		20	5,30
60	411030060	186	180		20	5,89
65	411030065	201	195		20	6,92

Z	codice	de	dp	dm	D1	Kg.
70	411030070	216	210		25	8,00
72	411030072	222	216		25	8,47
75	411030075	231	225		25	9,21
76	411030076	234	228		25	9,46
80	411030080	246	240		25	10,49
85	411030085	261	255		25	11,86
90	411030090	276	270		25	13,32
95	411030095	291	285		25	14,86
100	411030100	306	300		25	16,48
110	411030110	336	320		25	19,97
114	411030114	348	342		30	21,40
120	411030120	366	360		30	23,74
127	411030127	387	381		30	26,61



RUOTE DENTATE CILINDRICHE CYLINDRICAL GEARS

MODULO 4

ANGOLO DI PRESSIONE **20°**

A	B
60	40

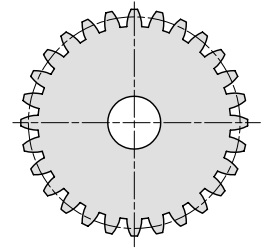
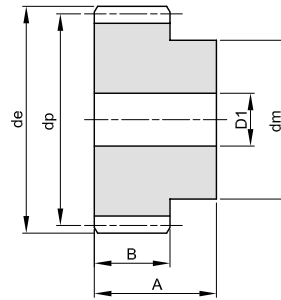
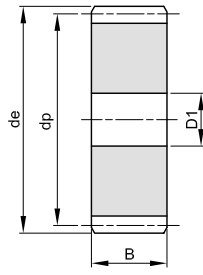

Materiale: Acciaio C45

Z	codice	de	dp	dm	D1	Kg.
12	401040012	56	48	35	14	0,63
13	401040013	60	52	40	14	0,78
14	401040014	64	56	45	14	0,93
15	401040015	68	60	45	14	1,05
16	401040016	72	64	50	16	1,20
17	401040017	76	68	50	16	1,33
18	401040018	80	72	50	16	1,47
19	401040019	84	76	60	16	1,75
20	401040020	88	80	60	16	1,90
21	401040021	92	84	70	16	2,22
22	401040022	96	88	70	16	2,39
23	401040023	100	92	75	20	2,60
24	401040024	104	96	75	20	2,79
25	401040025	108	100	75	20	2,98
26	401040026	112	104	75	20	3,18
27	401040027	116	108	75	20	3,39
28	401040028	120	112	75	20	3,60
29	401040029	124	116	75	20	3,83
30	401040030	128	120	75	20	4,06
31	401040031	132	124	80	20	4,39
32	401040032	136	128	80	20	4,64
33	401040033	140	132	80	20	4,90
34	401040034	144	136	80	20	5,16
35	401040035	148	140	80	20	5,43
36	401040036	152	144	80	25	5,63
38	411040038	160	152		25	5,20
40	411040040	168	160		25	6,11
45	411040045	188	180		25	7,78
48	411040048	200	192		25	8,87
50	411040050	208	200		25	9,65
52	411040052	216	208		25	10,45
55	411040055	228	220		25	11,71
57	411040057	236	228		25	12,59
60	411040060	248	240		25	13,97
65	411040065	268	260		25	16,43
70	411040070	288	280		25	19,09
75	411040075	308	300		25	21,94
76	411040076	312	304		30	22,47
80	411040080	328	320		30	24,93
85	411040085	348	340		30	28,18
90	411040090	368	360		30	31,62
95	411040095	388	380		30	35,26
100	411040100	408	400		30	39,11

Z	codice	de	dp	dm	D1	Kg.
110	411040110	448	440		30	47,38
114	411040114	464	456		30	50,91



RUOTE DENTATE CILINDRICHE CYLINDRICAL GEARS

MODULO 8

ANGOLO DI PRESSIONE 20°

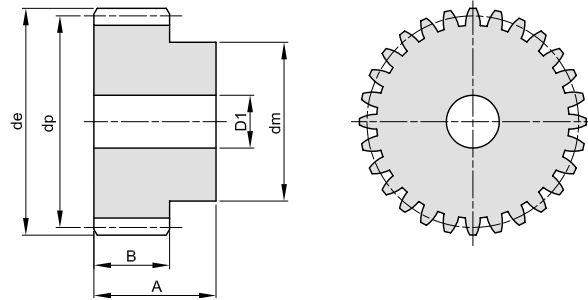

A	B
110	80

Materiale: Acciaio C45

Z	codice	de	dp	dm	D1	Kg.
15	401080015	136	120	90	25	7,96
18	401080018	160	144	100	25	11,34
20	401080020	176	160	120	30	14,38
24	401080024	208	192	150	30	21,25
25	401080025	216	200	150	30	22,85
30	401080030	256	240	190	30	33,50

Z	codice	de	dp	dm	D1	Kg.



RUOTE DENTATE CILINDRICHE TEMPERATE AD INDUZIONE CYLINDRICAL GEARS WITH HARDENED TEETH

MODULO 2

ANGOLO DI PRESSIONE **20°**

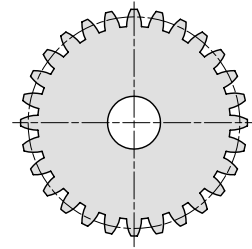
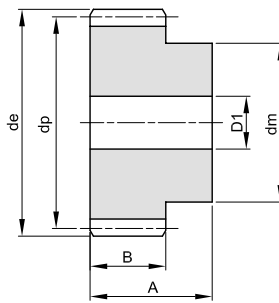

A	B
35	20

Materiale: Acciaio C45

Z	codice	de	dp	dm	D1	Kg.
12	402020012	28	24	18	10	0,08
15	402020015	34	30	24	10	0,14
18	402020018	40	36	25	10	0,19
20	402020020	44	40	30	10	0,26
24	402020024	52	48	35	12	0,36
25	402020025	54	50	35	12	0,39
30	402020030	64	60	40	14	0,55
36	402020036	76	72	45	14	0,78
40	402020040	84	80	50	14	0,97
50	402020050	104	100	70	16	1,62
60	402020060	124	120	70	16	2,16

Z	codice	de	dp	dm	D1	Kg.



RUOTE DENTATE CILINDRICHE TEMPERATE AD INDUZIONE CYLINDRICAL GEARS WITH HARDENED TEETH

MODULO 2,5

ANGOLO DI PRESSIONE **20°**

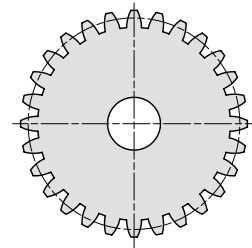
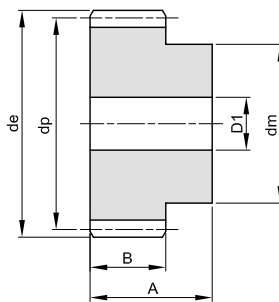

A	B
45	25

Materiale: Acciaio C45

Z	codice	de	dp	dm	D1	Kg.
12	402025012	35	30	22	10	0,17
15	402025015	42,5	37,5	30	10	0,30
18	402025018	50	45	35	12	0,42
20	402025020	55	50	40	12	0,54
24	402025024	65	60	45	14	0,74
25	402025025	67,5	62,5	50	14	0,85
30	402025030	80	75	55	14	1,18
36	402025036	95	90	60	16	1,61
40	402025040	105	100	70	16	2,06
50	402025050	130	125	80	20	3,07
60	402025060	155	150	100	20	4,57

Z	codice	de	dp	dm	D1	Kg.



RUOTE DENTATE CILINDRICHE TEMPERATE AD INDUZIONE CYLINDRICAL GEARS WITH HARDENED TEETH

MODULO 3

ANGOLO DI PRESSIONE 20°

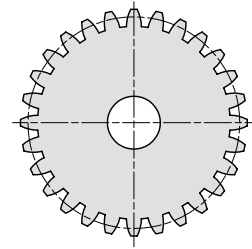
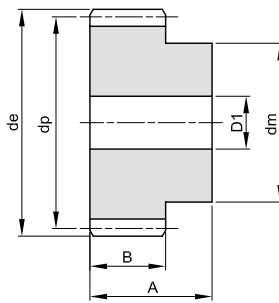

A	B
50	30

Materiale: Acciaio C45

Z	codice	de	dp	dm	D1	Kg.
12	402030012	42	36	27	12	0,28
15	402030015	51	45	35	12	0,47
18	402030018	60	54	45	14	0,72
20	402030020	66	60	45	14	0,84
24	402030024	78	72	50	16	1,18
25	402030025	81	75	60	16	1,39
30	402030030	96	90	60	16	1,85
36	402030036	114	108	70	20	2,62
40	402030040	126	120	80	20	3,31

Z	codice	de	dp	dm	D1	Kg.



RUOTE DENTATE CILINDRICHE TEMPERATE AD INDUZIONE CYLINDRICAL GEARS WITH HARDENED TEETH

MODULO 4

ANGOLO DI PRESSIONE 20°

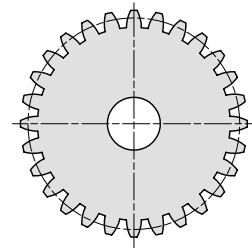
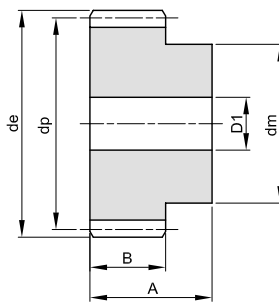

A	B
60	40

Materiale: Acciaio C45

Z	codice	de	dp	dm	D1	Kg.
12	402040012	56	48	35	14	0,63
15	402040015	68	60	45	14	1,05
18	402040018	80	72	50	16	1,47
20	402040020	88	80	60	16	1,90
24	402040024	104	96	75	20	2,79
25	402040025	108	100	75	20	2,98
30	402040030	128	120	75	20	4,06
36	402040036	152	144	80	25	5,63

Z	codice	de	dp	dm	D1	Kg.



RUOTE DENTATE CILINDRICHE TEMPERATE AD INDUZIONE CYLINDRICAL GEARS WITH HARDENED TEETH

MODULO 5

ANGOLO DI PRESSIONE **20°**

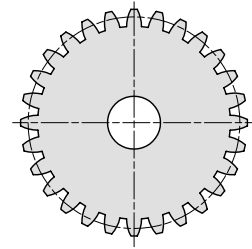
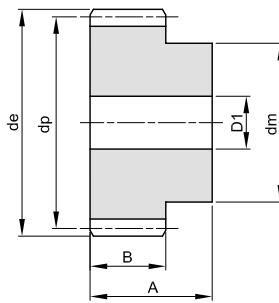

A	B
75	50

Materiale: Acciaio C45

Z	codice	de	dp	dm	D1	Kg.
12	402050012	70	60	45	20	1,21
15	402050015	85	75	60	20	2,07
18	402050018	100	90	70	20	3,02
20	402050020	110	100	80	20	3,83
24	402050024	130	120	90	20	5,44
25	402050025	135	125	90	20	5,82
30	402050030	160	150	110	25	8,44

Z	codice	de	dp	dm	D1	Kg.



RUOTE DENTATE CILINDRICHE TEMPERATE AD INDUZIONE CYLINDRICAL GEARS WITH HARDENED TEETH

MODULO 6

ANGOLO DI PRESSIONE **20°**

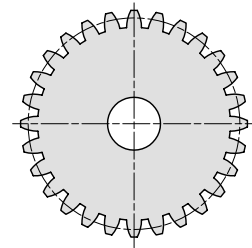
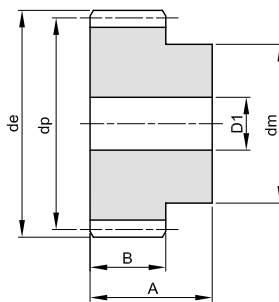

A	B
80	60

Materiale: Acciaio C45

Z	codice	de	dp	dm	D1	Kg.
12	402060012	84	72	54	20	1,98
15	402060015	102	90	70	20	3,29
16	402060016	108	96	75	20	3,80
18	402060018	120	108	80	20	4,76
20	402060020	132	120	90	20	5,99
24	402060024	156	144	110	25	8,70
25	402060025	162	150	110	25	9,33

Z	codice	de	dp	dm	D1	Kg.



RUOTE DENTATE CILINDRICHE IN ACCIAIO INOX CYLINDRICAL GEARS IN STAINLESS STEEL

MODULO 1

ANGOLO DI PRESSIONE 20°

A	B
25	15

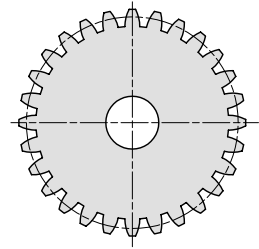
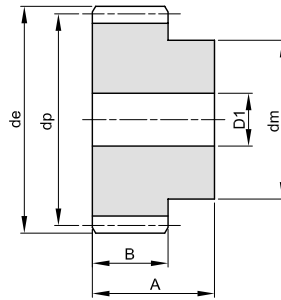
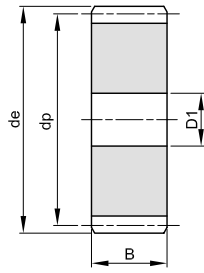

Materiale: INOX AISI 304 L

Z	codice	de	dp	dm	D1	Kg.
12	403010012	14	12	9		0,01
13	403010013	15	13	10		0,02
14	403010014	16	14	11		0,02
15	403010015	17	15	12		0,02
16	403010016	18	16	13		0,03
18	403010018	20	18	15	8	0,03
20	403010020	22	20	16	8	0,04
24	403010024	26	24	20	10	0,06
25	403010025	27	25	20	10	0,07
30	403010030	32	30	20	10	0,09
35	403010035	37	35	25	10	0,14
40	403010040	42	40	25	10	0,17

Z	codice	de	dp	dm	D1	Kg.
50	403010050	52	50	30	12	0,26
60	403010060	62	60	40	12	0,41
70	403010070	72	70	50	12	0,58
80	403010080	82	80		12	0,58
90	403010090	92	90		12	0,73
100	403010100	102	100		12	0,91
110	403010110	112	110		12	1,10
120	403010120	122	120		12	1,32



RUOTE DENTATE CILINDRICHE IN ACCIAIO INOX CYLINDRICAL GEARS IN STAINLESS STEEL

MODULO 1,5

ANGOLO DI PRESSIONE 20°

A	B
30	17

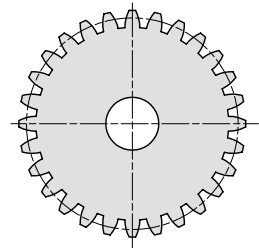
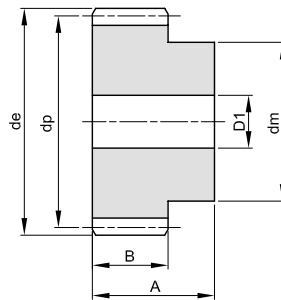
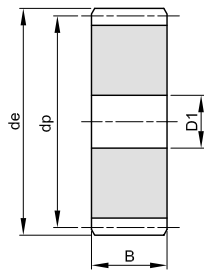

Materiale: INOX AISI 304 L

Z	codice	de	dp	dm	D1	Kg.
12	403015012	21,0	18,0	14	8	0,04
13	403015013	22,5	19,5	15	8	0,05
14	403015014	24,0	21,0	17	8	0,06
15	403015015	25,5	22,5	18	8	0,07
18	403015018	30,0	27,0	20	8	0,10
20	403015020	33,0	30,0	25	8	0,13
24	403015024	39,0	36,0	25	10	0,17
25	403015025	40,5	37,5	25	10	0,18
30	403015030	48,0	45,0	30	12	0,26
40	403015040	63,0	60,0	40	12	0,48
50	403015050	78,0	75,0	50	14	0,76
60	403015060	93,0	90,0	60	16	1,09

Z	codice	de	dp	dm	D1	Kg.
70	403015070	108,0	105,0	70	16	1,50
80	403015080	123,0	120,0		16	1,48
120	403015120	183,0	180,0		16	3,36



RUOTE DENTATE CILINDRICHE IN ACCIAIO INOX CYLINDRICAL GEARS IN STAINLESS STEEL

MODULO 2

ANGOLO DI PRESSIONE 20°

A	B
35	20

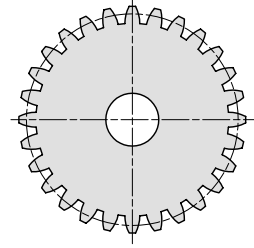
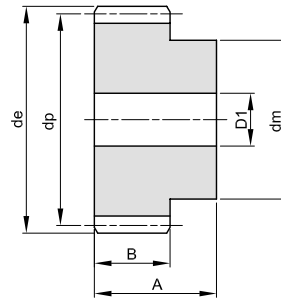
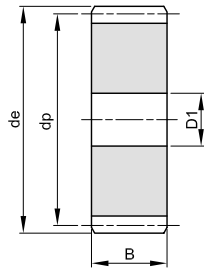

Materiale: INOX AISI 304 L

Z	codice	de	dp	dm	D1	Kg.
12	403020012	28	24	18	10	0,08
13	403020013	30	26	20	10	0,10
14	403020014	32	28	22	10	0,12
15	403020015	34	30	24	10	0,14
20	403020020	44	40	30	10	0,26
24	403020024	52	48	35	12	0,36
25	403020025	54	50	35	12	0,39
30	403020030	64	60	40	14	0,55
40	403020040	84	80	50	14	0,97
50	403020050	104	100	70	16	1,62
60	403020060	124	120	70	16	2,16
80	403020080	164	160		20	3,09

Z	codice	de	dp	dm	D1	Kg.



RUOTE DENTATE CILINDRICHE IN ACCIAIO INOX CYLINDRICAL GEARS IN STAINLESS STEEL

MODULO 2,5

ANGOLO DI PRESSIONE 20°

A	B
45	25

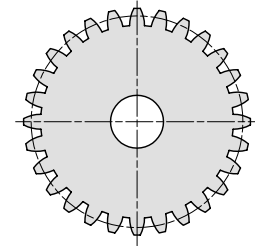
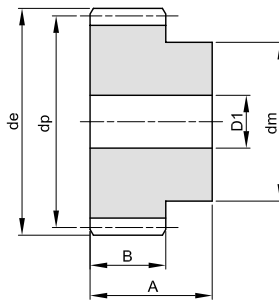

Materiale: INOX AISI 304 L

Z	codice	de	dp	dm	D1	Kg.
12	403025012	35,0	30,0	22	10	0,17
13	403025013	37,5	32,5	25	10	0,21
14	403025014	40,0	35,0	28	10	0,25
15	403025015	42,5	37,5	30	10	0,30
20	403025020	55,0	50,0	40	12	0,54
24	403025024	65,0	60,0	45	14	0,74
25	403025025	67,5	62,5	50	14	0,85
30	403025030	80,0	75,0	55	14	1,18
40	403025040	105,0	100,0	70	16	2,06
50	403025050	130,0	125,0	80	20	3,07
60	403025060	155,0	150,0	100	20	4,57

Z	codice	de	dp	dm	D1	Kg.



RUOTE DENTATE CILINDRICHE IN ACCIAIO INOX CYLINDRICAL GEARS IN STAINLESS STEEL

MODULO 3

ANGOLO DI PRESSIONE 20°

A	B
50	30

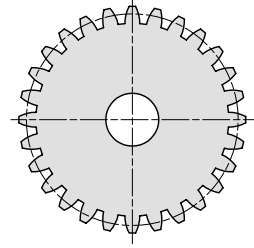
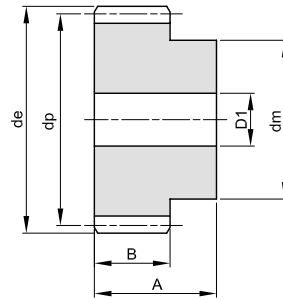
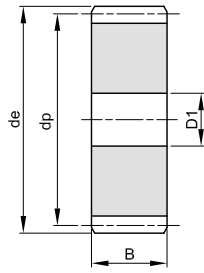

Materiale: INOX AISI 304 L

Z	codice	de	dp	dm	D1	Kg.
12	403030012	42	36	27	12	0,28
15	403030015	51	45	35	12	0,47
20	403030020	66	60	45	14	0,84
24	403030024	78	72	50	16	1,18
25	403030025	81	75	60	16	1,39
30	403030030	96	90	60	16	1,85
40	403030040	126	120	80	20	3,31
50	403030050	156	150		20	4,06
60	403030060	186	180		20	5,89

Z	codice	de	dp	dm	D1	Kg.



RUOTE DENTATE CILINDRICHE IN ACCIAIO INOX CYLINDRICAL GEARS IN STAINLESS STEEL

MODULO 4

ANGOLO DI PRESSIONE 20°

A	B
60	40

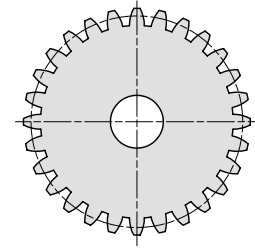
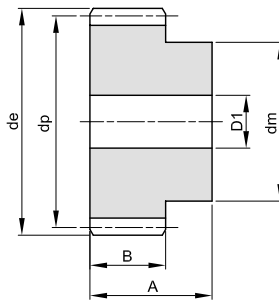

Materiale: INOX AISI 304 L

Z	codice	de	dp	dm	D1	Kg.
12	403040012	56	48	35	14	0,63
13	403040013	60	52	40	14	0,78
14	403040014	64	56	45	14	0,93
15	403040015	68	60	45	14	1,05
20	403040020	88	80	60	16	1,90
24	403040024	104	96	75	20	2,79
25	403040025	108	100	75	20	2,98
30	403040030	128	120	75	20	4,06

Z	codice	de	dp	dm	D1	Kg.



CREMAGLIERE INTESTATE PER IL MONTAGGIO CONTINUO - ANGOLO DI PRESSIONE 20°

RACKS FOR CONTINUOUS MOUNTING - PRESSURE ANGLE 20°

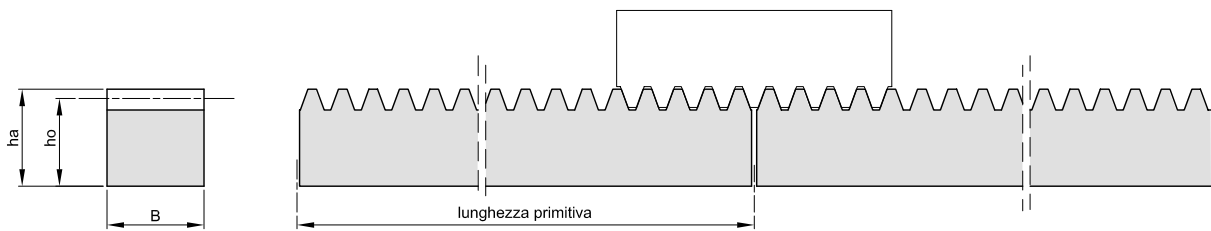

Materiale: Acciaio C45 / * Materiale: Acciaio 40Cr

modulo x lunghezza	codice	lunghezza primitiva	denti	B x ha	ho	Kg.
1 x 500	490110050	499,51	159	15 x 15	14	0,8
1 x 1000	490110100	1002,17	319	15 x 15	14	1,6
1 x 2000	490110200	2001,19	637	15 x 15	14	3,3
1 x 3000	490110300	3000,22	955	15 x 15	14	4,9
1,5 x 500	490115050	499,51	106	17 x 17	15,5	1
1,5 x 1000	490115100	1003,74	213	17 x 17	15,5	2,1
1,5 x 2000	490115200	2002,77	425	17 x 17	15,5	4,1
1,5 x 3000	490115300	3001,79	637	17 x 17	15,5	6,1
2 x 500	490120050	502,65	80	20 x 20	18	1,4
2 x 1000	490120100	1005,31	160	20 x 20	18	2,8
2 x 2000	490120200	2004,34	319	20 x 20	18	5,6
2 x 3000	490120300	3003,36	478	20 x 20	18	8,4
2,5 x 500	490125050	502,65	64	25 x 25	22,5	2,2
2,5 x 1000	490125100	1005,31	128	25 x 25	22,5	4,4
2,5 x 2000	490125200	2002,77	255	25 x 25	22,5	8,7
2,5 x 3000	490125300	3000,22	382	25 x 25	22,5	13,0
3 x 500	490130050	499,51	53	30 x 30	27	3,2
3 x 1000	490130100	1008,45	107	30 x 30	27	6,3
3 x 2000	490130200	2007,48	213	30 x 30	27	12,6
3 x 3000	490130300	3006,5	319	30 x 30	27	18,6
4 x 1000	490440100	1005,31	80	30 x 30	26	6
4 x 2000	490440200	2010,62	160	30 x 30	26	11,94
4 x 500	490140050	502,65	40	40 x 40	36	5,6
4 x 1000	490140100	1005,31	80	40 x 40	36	11,2
4 x 2000	490140200	2010,62	160	40 x 40	36	22,4
4 x 3000	490140300	3003,36	239	40 x 40	36	31,3
* 5 x 500	490150050	502,65	32	50 x 50	45	8,7
* 5 x 1000	490150100	1005,31	64	50 x 50	45	17,5
* 5 x 2000	490150200	2010,62	128	50 x 50	45	35
* 5 x 3000	490150300	3000,22	191	50 x 50	45	52
* 6 x 1000	490160100	1017,88	54	60 x 60	54	25,2
* 6 x 2000	490160200	2016,90	107	60 x 60	54	50,4
* 8 x 1000	490180100	1005,31	40	80 x 80	72	44
* 8 x 2000	490180200	2010,62	80	80 x 80	72	89



CREMAGLIERE INTESTATE PER IL MONTAGGIO CONTINUO - TEMPRATE AD INDUZIONE RACKS FOR CONTINUOUS MOUNTING WITH HARDENED TEETH

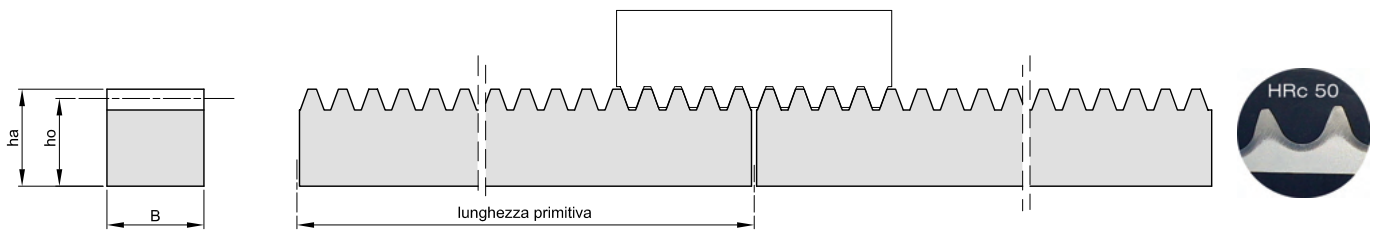

Angolo di pressione 20° / Pressure angle 20°

Materiale: Acciaio C45 / * Materiale: Acciaio 40 Cr

modulo x lunghezza	codice	lunghezza primitiva	denti	B x ha	ho	Kg.
2 x 1000	492120100	1005,31	160	20 x 20	18	2,8
2 x 2000	492120200	2004,34	319	20 x 20	18	5,6
2,5 x 1000	492125100	1005,31	128	25 x 25	22,5	4,4
2,5 x 2000	492125200	2002,77	255	25 x 25	22,5	8,7
3 x 1000	492130100	1008,45	107	30 x 30	27	6,3
3 x 2000	492130200	2007,48	213	30 x 30	27	12,6
4 x 1000	492140100	1005,31	80	40 x 40	36	11,2
4 x 2000	492140200	2010,62	160	40 x 40	36	22,4
* 5 x 1000	492150100	1005,31	64	50 x 50	45	17,5
* 5 x 2000	492150200	2010,62	128	50 x 50	45	35,0
* 6 x 1000	492160100	1017,88	54	60 x 60	54	25,2
* 6 x 2000	492160200	2016,90	107	60 x 60	54	50,4



CREMAGLIERE INTESTATE PER IL MONTAGGIO CONTINUO IN ACCIAIO INOX RACKS FOR CONTINUOUS MOUNTING IN STAINLESS STEEL

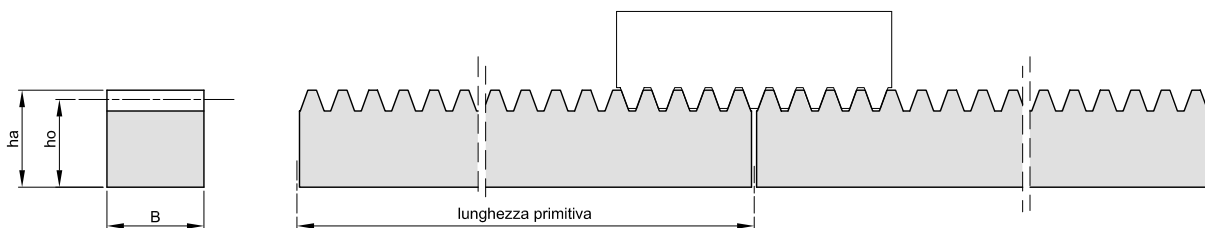

Angolo di pressione 20° / Pressure angle 20°

Materiale: INOX AISI 304

modulo x lunghezza	codice	lunghezza primitiva	denti	B x ha	ho	Kg.
1 x 1000	493110100	1002,17	319	15 x 15	14	1,6
1 x 2000	493110200	2001,19	637	15 x 15	14	3,3
1,5 x 1000	493115100	1003,74	213	17 x 17	15,5	2,1
1,5 x 2000	493115200	2002,77	425	17 x 17	15,5	4,1
2 x 1000	493120100	1005,31	160	20 x 20	18	2,8
2 x 2000	493120200	2004,34	319	20 x 20	18	5,6
2,5 x 1000	493125100	1005,31	128	25 x 25	22,5	4,4
2,5 x 2000	493125200	2002,77	255	25 x 25	22,5	8,7
3 x 1000	493130100	1008,45	107	30 x 30	27	6,3
3 x 2000	493130200	2007,48	213	30 x 30	27	12,6
4 x 1000	493140100	1005,31	80	40 x 40	36	11,2
4 x 2000	493140200	2010,62	160	40 x 40	36	22,4



RUOTE DENTATE CONICHE DENTI DIRITTI TIPO "A" CONICAL STRAIGHT TOOTHED GEARS TYPE "A"

RAPPORTO 1:1

ANGOLO DI PRESSIONE **20°**

ANGOLO FRA GLI ALBERI $\Sigma = 90^\circ$

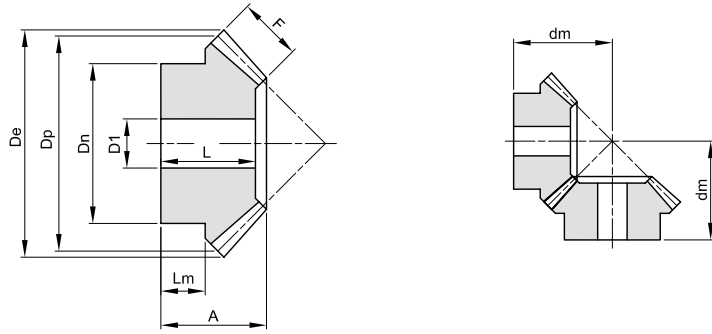

Materiale: Acciaio C45

modulo	denti	codice	De	Dp	A	F	Dn	D1	dm	L	Lm	Kg.
1,5	16	421015016	26,1	24,0	18	8	18	8	23,8	17	8,9	0,03
1,5	20	421015020	32,1	30,0	20	8	22	10	28,7	18	9,8	0,05
1,5	22	421015022	35,1	33,0	20	8	25	10	30,2	18	9,7	0,07
1,5	25	421015025	39,6	37,5	23	8	28	10	35,4	21	12	0,10
1,5	30	421015030	47,1	45,0	25	10	30	12	39,7	22,5	12	0,15
2	16	421020016	34,8	32,0	20	9	25	10	28,8	17	9,3	0,06
2	20	421020020	42,8	40,0	25	12	32	10	35,7	22	12	0,14
2	22	421020022	46,8	44,0	25	12	36	10	37,7	22	11,7	0,18
2	25	421020025	52,8	50,0	28	14	40	12	42,3	25	12,3	0,25
2	30	421020030	62,8	60,0	30	16	50	12	47,8	27	12,8	0,41
2,5	16	421025016	43,5	40,0	25,5	10	32	12	37,3	22	13,3	0,13
2,5	20	421025020	53,5	50,0	30,5	12	40	12	45,9	27	16	0,27
2,5	22	421025022	58,5	55,0	30,5	12	45	12	48,3	27	15,9	0,34
2,5	25	421025025	66,0	62,5	33,5	15	50	15	53,0	30	16	0,47
2,5	30	421025030	78,5	75,0	35,5	18	55	15	59,1	32	16	0,69
3	16	421030016	52,2	48,0	30	12	40	15	44,2	26	16,2	0,24
3	20	421030020	64,2	60,0	35	18	45	15	51,1	31	13,6	0,41
3	22	421030022	70,2	66,0	35	18	50	15	54,0	31	13	0,52
3	25	421030025	79,2	75,0	38	20	55	15	60,0	34	16	0,72
3	30	421030030	94,2	90,0	40	22	60	20	68,1	36	19	0,99
3,5	16	421035016	60,9	56,0	35,5	16	45	15	50,8	31	17,2	0,38
3,5	20	421035020	74,9	70,0	40,5	22	55	15	58,6	36	19	0,68
3,5	22	421035022	81,9	77,0	40,5	22	60	15	62,0	36	18	0,84
3,5	25	421035025	92,4	87,5	43,5	26	65	20	67,5	39	18	1,10
3,5	30	421035030	109,9	105,0	45,5	30	70	20	75,4	41	17	1,61
4	16	421040016	69,6	64,0	38	18	50	15	55,6	33	16,6	0,52
4	20	421040020	85,6	80,0	43	25	60	18	63,8	38	18	0,90
4	22	421040022	93,6	88,0	43	25	65	18	67,7	38	18	1,11
4	25	421040025	105,6	100,0	45	28	70	20	73,5	40	18	1,45
4	30	421040030	125,6	120,0	48	32	80	20	83,7	43	16	2,66
4,5	16	421045016	78,3	72,0	43	20	55	18	63,0	37	18,5	0,73
4,5	20	421045020	96,3	90,0	48	28	65	20	71,5	42	18	1,25
4,5	22	421045022	105,3	99,0	48	28	70	20	75,8	42	18	1,55
4,5	25	421045025	118,8	112,5	50	32	75	20	81,8	44	18	2,04
4,5	30	421045030	141,3	135,0	53	35	90	20	93,8	47	17	3,24
5	16	421050016	87,0	80,0	45,5	22	60	20	67,8	39	17,8	0,94
5	20	421050020	107,1	100,0	50,5	30	70	20	77,3	44	18,5	1,61
5	22	421050022	117,1	110,0	50,5	30	80	20	82,2	44	18,5	2,08
5	25	421050025	132,1	125,0	54,5	35	90	20	90,2	48	18,5	2,94
5	30	421050030	157,1	150,0	56,5	38	110	20	102,4	50	18	4,46



RUOTE DENTATE CONICHE DENTI DIRITTI TIPO "A" CONICAL STRAIGHT TOOTHED GEARS TYPE "A"

RAPPORTO 1:2

ANGOLO DI PRESSIONE 20°

ANGOLO FRA GLI ALBERI $\Sigma = 90^\circ$

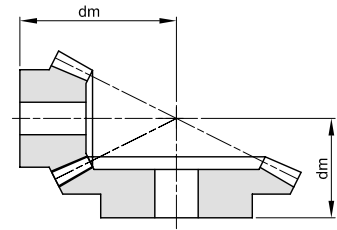
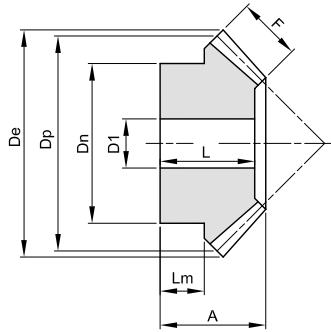

Materiale: Acciaio C45

modulo	denti	codice	De	Dp	A	F	Dn	D1	dm	L	Lm	Kg.
1,5	16	422015016	26,7	24	18,5	8	21	10	34,9	17	10,3	0,04
1,5	32	422015032	49,3	48	20	8	32	12	27,5	17,5	10	0,14
2	16	422020016	35,6	32	23	10	27	10	45,4	21	12,2	0,09
2	32	422020032	65,8	64	25	10	40	12	35,2	22	10	0,14
2,5	16	422025016	44,4	40	27,5	12	34	12	56,0	25	14,4	0,16
2,5	32	422025032	82,2	80	30	12	50	15	43,0	26,5	15	0,59
3	16	422030016	53,4	48	28	15	40	15	61,6	25	11,6	0,23
3	32	422030032	98,7	96	35	15	60	15	50,4	30,5	15	1,05
3,5	16	422035016	62,3	56	33,5	18	48	15	72,3	30,5	14,4	0,40
3,5	32	422035032	115,1	112	40	18	70	20	57,7	35	19	1,57
4	16	422040016	71,1	64	36	20	50	20	80,8	32	13,4	0,49
4	32	422040032	131,6	128	45	20	80	20	65,5	39,5	23	2,29
4,5	16	422045016	80,1	72	39,5	22	60	20	90,4	35	15,4	0,75
4,5	32	422045032	148,0	144	50	22	80	20	73,2	43,5	24	2,99
5	16	422050016	88,9	80	50	25	60	20	106,1	45	21,1	1,07
5	32	422050032	164,5	160	55	25	85	20	80,6	48	27	3,95



RUOTE DENTATE CONICHE DENTI DIRITTI TIPO "A" CONICAL STRAIGHT TOOTHED GEARS TYPE "A"

RAPPORTO 1:3

ANGOLO DI PRESSIONE 20°

ANGOLO FRA GLI ALBERI $\Sigma = 90^\circ$

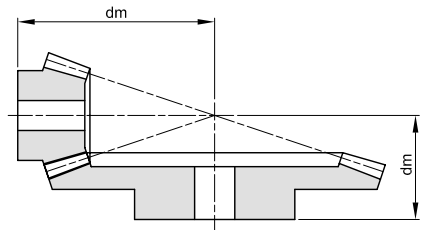
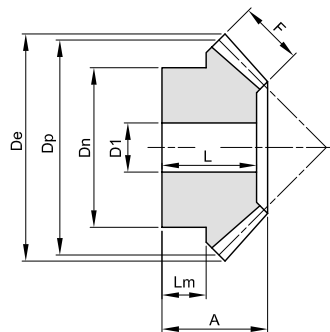

Materiale: Acciaio C45

modulo	denti	codice	De	Dp	A	F	Dn	D1	dm	L	Lm	Kg.
1,5	16	423015016	26,9	24	22	12	20	10	46,3	21	9,7	0,04
1,5	48	423015048	72,9	72	22	12	42	15	29,2	19	12	0,31
2	16	423020016	35,8	32	25,5	15	25	12	58,9	24	9,4	0,08
2	48	423020048	97,3	96	26	15	50	15	35,9	22	13	0,67
2,5	16	423025016	44,7	40	28	18	33	14	70,4	26	9,2	0,15
2,5	48	423025048	121,6	120	32	18	60	20	44,6	27	16	1,22
3	16	423030016	53,7	48	30	18	42	15	84,2	28	11,2	0,27
3	48	423030048	145,9	144	38	18	65	20	54,1	32	19	2,01
3,5	16	423035016	62,6	56	36,5	22	48	15	98,8	34	13,4	0,45
3,5	48	423035048	170,2	168	44	22	75	20	62,5	37	23	3,08
4	16	423040016	71,6	64	42	25	55	20	113,3	39	15,7	0,67
4	48	423040048	194,5	192	50	25	85	20	71,2	42	27	4,40
4,5	16	423045016	80,6	72	53	28	60	20	133,4	50	23,4	1,05
4,5	48	423045048	218,8	216	58	28	90	20	81,9	49	27	7,23
5	16	423050016	89,5	80	60	35	60	20	145,7	57	22,5	1,38
5	48	423050048	243,1	240	65	35	100	20	90,5	55	35	8,72



RUOTE DENTATE CONICHE DENTI DIRITTI TIPO "A" CONICAL STRAIGHT TOOTHED GEARS TYPE "A"

RAPPORTO 1:4

ANGOLO DI PRESSIONE **20°**

ANGOLO FRA GLI ALBERI $\Sigma = 90^\circ$

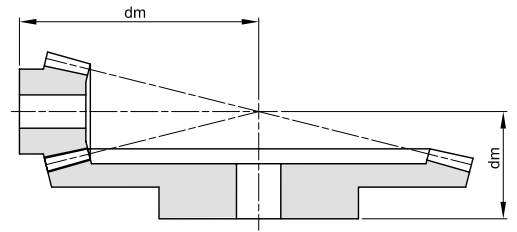
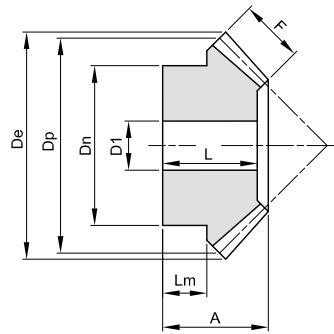

Materiale: Acciaio C45

modulo	denti	codice	De	Dp	A	F	Dn	D1	dm	L	Lm	Kg.
1,5	16	424015016	26,9	24	25	12	18	10	61,1	24	12,2	0,04
1,5	64	424015064	96,7	96	25	12	60	15	33	22	13	0,75
2	16	424020016	35,9	32	24	15	25	12	73,1	23	8,5	0,08
2	64	424020064	129,0	128	28	15	70	20	38,9	24	14	1,35
2,5	16	424025016	44,9	40	30,5	18	34	15	92,6	29	11,7	0,18
2,5	64	424025064	161,2	160	35	18	80	20	48,8	30	16	2,70
3	16	424030016	53,8	48	32	20	40	15	108,0	30	11,1	0,29
3	64	424030064	193,5	192	42	20	90	20	58,8	36	22	4,12
3,5	16	424035016	62,8	56	40	25	45	15	127,1	38	14	0,48
3,5	64	424035064	225,7	224	50	25	100	20	69,3	43	22	7,53
4	16	424040016	71,7	64	50	30	50	20	148,2	48	18,5	0,75
4	64	424040064	257,9	256	60	30	110	20	81,8	52	30	10,66
4,5	16	424045016	80,7	72	55	32	60	20	167,1	53	21,6	1,12
4,5	64	424045064	290,1	288	65	32	120	20	89,8	57	35	13,80
5	16	424050016	89,7	80	60	35	65	20	185,1	58	23,2	1,54
5	64	424050064	322,4	320	70	35	120	20	97,7	61	42	15,60



RUOTE DENTATE CONICHE DENTI DIRITTI TIPO "B" CONICAL STRAIGHT TOOTHED GEARS TYPE "B"

RAPPORTO 1:1

ANGOLO DI PRESSIONE **20°**

ANGOLO FRA GLI ALBERI $\Sigma = 90^\circ$

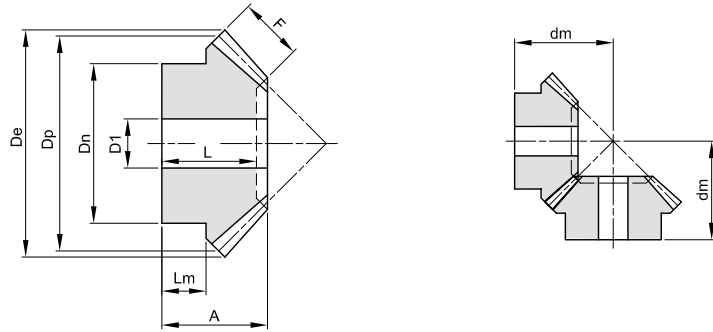

Materiale: Acciaio C45

modulo	denti	codice	De	Dp	A	F	Dn	D1	dm	L	Lm	Kg.
1	16	441010016	17,4	16,0	11,2	4	13,3	4	16		6,7	0,02
1	19	441010019	20,4	19,0	11,8	4	15,3	4	18		6,6	0,02
1	22	441010022	23,4	22,0	12,8	4,7	16,3	5	20		6,1	0,02
1	26	441010026	27,4	26,0	13,3	5,5	20,3	5	22		7	0,04
1	30	441010030	31,4	30,0	16,0	6,4	20,3	5	26		8	0,05
1,5	16	441015016	26,1	24,0	18,9	6	20,3	8	26		12,2	0,04
1,5	19	441015019	30,6	28,5	21,3	7	20,3	8	30		11,6	0,05
1,5	22	441015022	35,1	33,0	22,5	7,5	25,3	8	33		12,7	0,09
1,5	26	441015026	41,1	39,0	23,2	8,5	28,3	8	36		12	0,12
1,5	30	441015030	47,1	45,0	27,2	10	30,0	12	42		12,1	0,17
2	16	441020016	34,8	32,0	23,5	8	25,3	8	33		13,6	0,08
2	19	441020019	40,8	38,0	24,2	9	25,3	8	36		12	0,11
2	22	441020022	46,8	44,0	27,9	10	30,3	10	42		14	0,18
2	26	441020026	54,8	52,0	31,4	12	35,3	12	48		13,7	0,28
2	30	441020030	62,8	60,0	34,1	13	40,3	12	54		17	0,41
2,5	16	441025016	43,5	40,0	28,1	10	30,3	12	40		15,2	0,14
2,5	19	441025019	51,0	47,5	27,1	11	35,3	12	42		13	0,21
2,5	22	441025022	58,5	55,0	30,1	12	45,3	12	48		15,7	0,36
2,5	26	441025026	68,5	65,0	33,2	15	45,3	15	54		16	0,47
2,5	30	441025030	78,5	75,0	39,0	16	50,3	15	64		20	0,74
3	16	441030016	52,2	48,0	31,7	12	40,3	12	46		18,1	0,28
3	19	441030019	61,2	57,0	36,0	13	40,3	14	54		17,1	0,39
3	22	441030022	70,2	66,0	36,9	15	50,3	15	58		17,1	0,59
3	26	441030026	82,2	78,0	38,4	17	50,3	15	64		18	0,77
3	30	441030030	94,2	90,0	43,8	19	60,3	20	74		22	1,19
3,5	16	441035016	60,9	56,0	36,4	14	45,3	15	53		19,8	0,41
3,5	19	441035019	71,4	66,5	36,9	15	50,3	15	58		18	0,59
3,5	22	441035022	81,9	77,0	39,1	17	55,3	15	64		18	0,84
3,5	26	441035026	95,9	91,0	42,2	20	60,3	20	72		20	1,17
3,5	30	441035030	110,0	105,0	47,3	23	70,3	20	82	43	22	1,69
4	16	441040016	69,7	64,0	44,3	15	50,3	15	64		25,1	0,66
4	19	441040019	81,7	76,0	44,4	18	55,3	18	68		22	0,88
4	22	441040022	93,7	88,0	45,9	20	60,3	18	74		22	1,21
4	26	441040026	109,7	104,0	48,0	23	70,3	20	82	43	22	1,68
4	30	441040030	125,7	120,0	54,2	26	80,3	20	94	49	25	2,50
4,5	16	441045016	78,4	72,0	46,3	17,5	55,3	18	68		25	0,84
4,5	19	441045019	91,8	85,5	47,3	20	60,3	20	74		25	1,15
4,5	22	441045022	105,3	99,0	50,1	22	70,3	20	82		25	1,72
4,5	26	441045026	123,3	117,0	53,2	25	75,3	20	92	45	25	2,22
4,5	30	441045030	141,4	135,0	60,0	29	80,3	20	105	54	28	3,25
5	16	441050016	87,1	80,0	48,9	18	60,3	20	74		24,1	1,10
5	19	441050019	102,1	95,0	52,2	22	60,3	20	82		25	1,50
5	22	441050022	117,1	110,0	58,2	24	80,3	20	94	52	30	2,39
5	26	441050026	137,1	130,0	62,7	29	80,3	20	105	57	30	3,27
5	30	441050030	157,1	150,0	68,9	32	80,3	20	119	63	35	4,13



RUOTE DENTATE CONICHE DENTI DIRITTI TIPO "B" CONICAL STRAIGHT TOOTHED GEARS TYPE "B"

RAPPORTO 1:2

ANGOLO DI PRESSIONE 20°

ANGOLO FRA GLI ALBERI $\Sigma = 90^\circ$

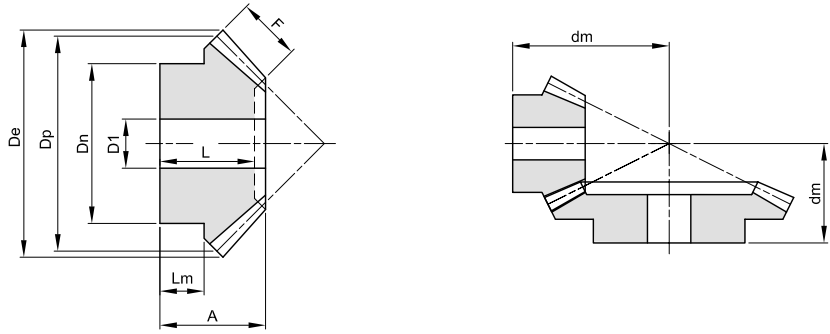

Materiale: Acciaio C45

modulo	denti	codice	De	Dp	A	F	Dn	D1	dm	L	Lm	Kg.
1	15	442010015	17,4	15,0	11,9	5	13,3	4	22		6,6	0,02
1	30	442010030	30,6	30,0	15,1	5	20,3	5	20	14	9	0,05
1,5	15	442015015	26,1	22,5	21,1	9	20,3	8	35		12	0,04
1,5	30	442015030	45,9	45,0	25,2	9	32,3	8	32	23	16	0,17
2	15	442020015	34,8	30,0	26	11,5	25,3	8	45		13,8	0,09
2	30	442020030	61,2	60,0	29,8	11,5	40,3	12	39	27	18	0,32
2,5	15	442025015	43,5	37,5	31,8	15	32,3	12	55		16,2	0,17
2,5	30	442025030	76,5	75,0	33,7	15	45,3	15	45	30	20	0,50
3	15	442030015	52,2	45,0	37,3	17	40,3	12	66		19,8	0,33
3	30	442030030	91,8	90,0	42,1	17	55,3	15	56	38	25	0,96
3,5	15	442035015	60,9	52,5	46,1	20,5	45,3	15	79		24,7	0,50
3,5	30	442035030	107,1	105,0	45	20,5	60,3	20	61	40	25	1,31
4	15	442040015	69,6	60,0	48,6	22,5	50,3	20	87		24,6	0,65
4	30	442040030	122,3	120,0	57,3	22,5	80,3	20	76	52	35	2,52
4,5	15	442045015	78,3	67,5	51,4	26	60,3	20	94		24,7	0,97
4,5	30	442045030	137,6	135,0	60,3	26	80,3	20	81	53	35	2,95
5	15	442050015	87,0	75,0	57,6	30	60,3	20	104		25,3	1,23
5	30	442050030	152,9	150,0	62,5	30	80,3	20	85	56	35	3,56



RUOTE DENTATE CONICHE DENTI DIRITTI TIPO "B" CONICAL STRAIGHT TOOTHED GEARS TYPE "B"

RAPPORTO 1:3

ANGOLO DI PRESSIONE 20°

ANGOLO FRA GLI ALBERI $\Sigma = 90^\circ$

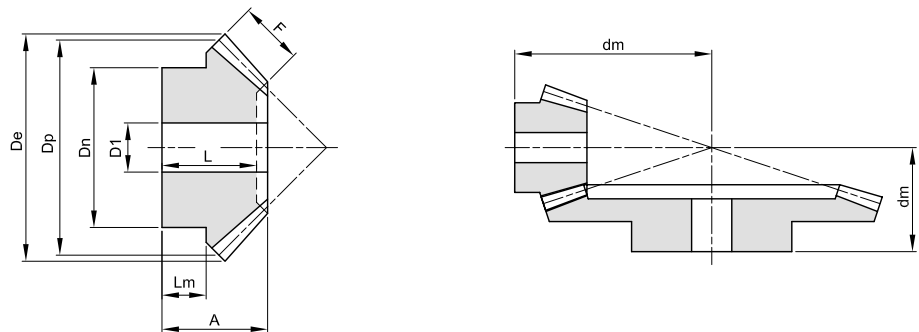

Materiale: Acciaio C45

modulo	denti	codice	De	Dp	A	F	Dn	D1	dm	L	Lm	Kg.
1	15	443010015	17,7	15,0	16,6	7,1	13,3	4	32		9,3	0,02
1	45	443010045	45,3	45,0	17,1	7,1	25,3	8	22	15	10	0,09
1,5	15	443015015	26,5	22,5	22,6	10,5	19,3	8	46		11,7	0,04
1,5	45	443015045	68,1	67,5	29,6	10,5	45,3	14	37	27	20	0,40
2	15	443020015	35,4	30,0	28,9	14	25,3	8	60		14,2	0,11
2	45	443020045	90,8	90,0	32,1	14	45,3	15	42	29	20	0,62
2,5	15	443025015	44,2	37,5	34,6	18	32,3	12	73		15,9	0,20
2,5	45	443025045	113,4	112,5	39,7	18	60,3	20	52	36	25	1,23
3	15	443030015	53,0	45,0	41,3	21	40,3	15	88		19,7	0,35
3	45	443030045	136,1	135,0	47,2	21	60,3	20	62	42,5	30	1,83
3,5	15	443035015	61,9	52,5	49,6	23,5	45,3	15	105		25,1	0,57
3,5	45	443035045	158,8	157,5	54,4	23,5	80,3	20	72	49	35	3,21
4	15	443040015	70,7	60,0	54,3	27,5	50,3	20	117		25,4	0,75
4	45	443040045	181,5	180,0	57,0	27,5	80,3	20	77	51	35	4,13
4,5	15	443045015	79,5	67,5	55,2	28,5	55,3	20	128		24,8	1,02
4,5	45	443045045	204,2	202,5	63,9	28,5	90,3	20	87	57	40	5,70
5	15	443050015	88,4	75,0	65,3	33	60,3	20	145		30	1,47
5	45	443050045	226,9	225,0	66,7	33	90,3	20	92	59	40	7,22



RUOTE DENTATE CONICHE DENTI DIRITTI TIPO "B" CONICAL STRAIGHT TOOTHED GEARS TYPE "B"

RAPPORTO 1:4

ANGOLO DI PRESSIONE **20°**

ANGOLO FRA GLI ALBERI $\Sigma = 90^\circ$

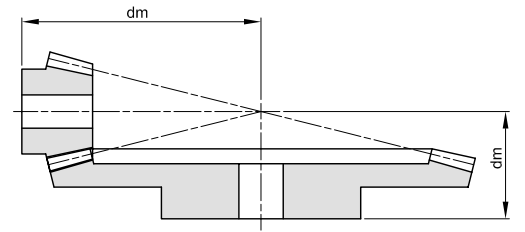
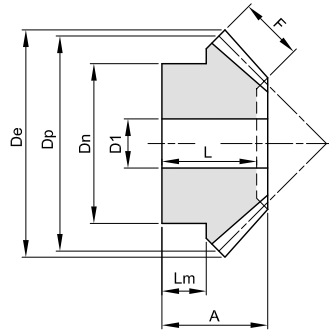

Materiale: Acciaio C45

modulo	denti	codice	De	Dp	A	F	Dn	D1	dm	L	Lm	Kg.
1	15	444010015	17,8	15,0	17,2	9,3	13,3	4	38		7,7	0,02
1	60	444010060	60,3	60,0	17,1	9,3	30,3	8	22	15	10	0,16
1,5	15	444015015	26,7	22,5	23,0	11	20,3	8	57		11,7	0,05
1,5	60	444015060	90,4	90,0	34	11	50,3	15	42	31	25	0,63
2	15	444020015	35,6	30,0	31	16	25,3	8	75		14,4	0,12
2	60	444020060	120,6	120,0	37,6	16	60,3	16	48	34	25	1,28
2,5	15	444025015	44,5	37,5	38,1	19	32,3	14	94		18,4	0,21
2,5	60	444025060	150,7	150,0	44,8	19	60,3	20	58	40	30	1,92
3	15	444030015	53,3	45,0	48,1	23	40,3	15	115		24,5	0,42
3	60	444030060	180,8	180,0	53,2	23	80,3	20	69	48	35	3,75
3,5	15	444035015	62,2	52,5	52,1	26	45,3	15	131		25,1	0,62
3,5	60	444035060	211,0	210,0	60,4	26	90,3	20	79	54	40	5,60
4	15	444040015	71,1	60,0	55,1	30	50,3	20	145		23,8	0,81
4	60	444040060	241,1	240,0	60,8	30	90,3	20	82	53	40	6,43
4,5	15	444045015	79,9	67,5	59,1	34	60,3	20	160		24,1	1,17
4,5	60	444045060	271,2	270,0	68,2	34	100,3	20	92	61	40	11,30
5	15	444050015	88,8	75,0	68,1	38	70,3	20	180		29,4	1,85
5	60	444050060	301,3	300,0	73,5	38	110,3	20	100	66	40	16,51



RUOTE DENTATE CONICHE DENTI SPIROIDALI CONICAL SPIRAL TOOTHED GEARS

RAPPORTO 1:1

ANGOLO DI PRESSIONE **20°**

ANGOLO FRA GLI ALBERI $\Sigma = 90^\circ$

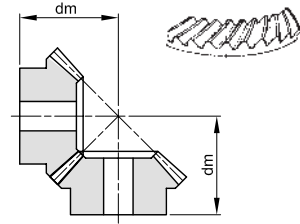
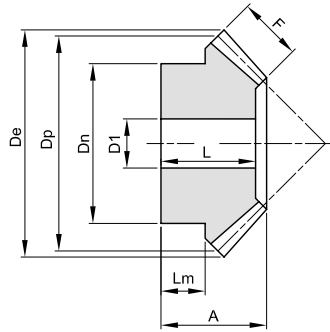

RUOTA MINORE CON ELICA SINISTRORSA
RUOTA MAGGIORE CON ELICA DESTROSA

Materiale: Acciaio C45

modulo	denti	codice		De	Dp	A	F	Dn	D1	dm	L	Lm	Kg.
		elica destra	elica sinistra										
2	16	461020016	461020017	34,4	32,0	20,1	9	25	10	29	17,0	9,5	0,06
2	20	461020020	461020021	42,4	40,0	25,2	12	32	10	36	22,0	12	0,14
2	25	461020025	461020026	52,4	50,0	27,6	14	40	12	42	24,5	12	0,25
2	30	461020030	461020031	62,4	60,0	30,1	16	50	12	48	27,0	13	0,42
2,5	16	461025016	461025017	43,0	40,0	25,0	10	32	12	37	22,0	13	0,13
2,5	20	461025020	461025021	53,0	50,0	30,5	12	40	12	46	27,5	16	0,27
2,5	25	461025025	461025026	65,5	62,5	33,3	15	50	15	53	30,0	16	0,47
2,5	30	461025030	461025031	78,0	75,0	35,2	18	55	15	59	32,0	16	0,69
3	16	461030016	461030017	51,6	48,0	29,7	12	40	15	44	26,0	16	0,23
3	20	461030020	461030021	63,6	60,0	34,8	18	45	15	51	31,0	13,5	0,41
3	25	461030025	461030026	78,6	75,0	37,8	20	55	15	60	34,0	16	0,72
3	30	461030030	461030031	93,6	90,0	39,7	22	60	20	68	36,0	19	0,99
3,5	16	461035016	461035017	60,2	56,0	34,3	14	45	15	51	30,0	17,5	0,36
3,5	20	461035020	461035021	74,2	70,0	36,1	15	55	15	59	31,5	19	0,62
3,5	25	461035025	461035026	91,7	87,5	40,5	21	65	20	68	36,0	18	1,11
3,5	30	461035030	461035031	109,2	105,0	41,9	24	70	20	76	37,5	17	1,64
4	16	461040016	461040017	68,8	64,0	36,2	15	50	15	56	31,0	17	0,51
4	20	461040020	461040021	84,8	80,0	37,7	17	60	18	64	32,5	18	0,81
4	25	461040025	461040026	104,8	100,0	40,5	21	70	20	74	35,0	18	1,33
4	30	461040030	461040031	124,8	120,0	43,4	25	80	25	84	38,0	16	2,10
4,5	16	461045016	461045017	77,4	72,0	39,5	15	55	18	63	33,5	18,5	0,67
4,5	20	461045020	461045021	95,4	90,0	43,0	20	65	20	72	37,0	18	1,14
4,5	25	461045025	461045026	117,9	112,5	45,3	25	75	20	82	39,0	18	1,87
4,5	30	461045030	461045031	140,4	135,0	48,2	28	90	25	94	42,0	17	2,98
5	16	461050016	461050017	86,0	80,0	42,1	17	60	20	68	36,0	18	0,88
5	20	461050020	461050021	106,0	100,0	45,0	21	70	20	78	38,5	18,5	1,47
5	25	461050025	461050026	131,0	125,0	48,0	26	90	20	90	41,5	18,5	2,67
5	30	461050030	461050031	156,0	150,0	52,7	32	110	30	103	46,0	18	4,25



RUOTE DENTATE CONICHE DENTI SPIROIDALI CONICAL SPIRAL TOOTHED GEARS

RAPPORTO 1:2

ANGOLO DI PRESSIONE 20°

ANGOLO FRA GLI ALBERI $\Sigma = 90^\circ$

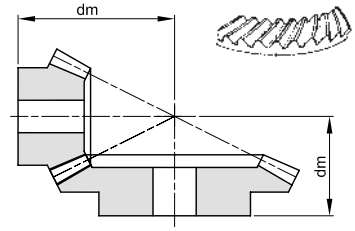
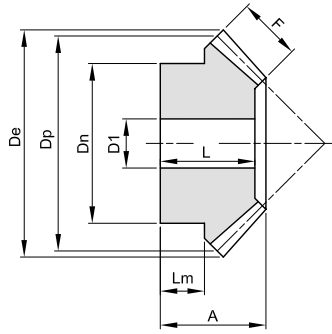

RUOTA MINORE CON ELICA SINISTRORSA
RUOTA MAGGIORE CON ELICA DESTROSA

Materiale: Acciaio C45

modulo	denti	codice	De	Dp	A	F	Dn	D1	dm	L	Lm	Kg.
2	16	462020016	36,1	32	22,6	10	27	10	45	21,0	11,7	0,09
2	32	462020032	65,0	64	24,1	10	40	12	35	21,5	10	0,32
2,5	16	462025016	45,1	40	27,6	12	34	12	56	25,5	14,5	0,17
2,5	32	462025032	81,2	80	29,2	12	50	15	43	25,5	15	0,57
3	16	462030016	54,1	48	28,4	15	40	15	62	25,5	12	0,25
3	32	462030032	97,5	96	34,6	15	60	15	51	30,0	15	1,03
3,5	16	462035016	63,2	56	33,3	18	48	15	72	30,5	14	0,42
3,5	32	462035032	113,7	112	39,1	18	70	20	58	34,0	19	1,51
4	16	462040016	72,2	64	36,3	20	50	20	81	32,5	13,5	0,52
4	32	462040032	130,0	128	44,2	20	80	20	66	38,5	23	2,21
4,5	16	462045016	81,2	72	40,2	22	60	20	91	35,5	16	0,80
4,5	32	462045032	146,2	144	49,3	22	80	25	74	42,5	24	2,88
5	16	462050016	90,2	80	50,1	25	60	20	106	45,5	21	1,16
5	32	462050032	162,5	160	53,7	25	85	25	81	46,5	27	2,79



RUOTE DENTATE CONICHE DENTI SPIROIDALI CONICAL SPIRAL TOOTHED GEARS

RAPPORTO 1:3

ANGOLO DI PRESSIONE 20°

ANGOLO FRA GLI ALBERI $\Sigma = 90^\circ$

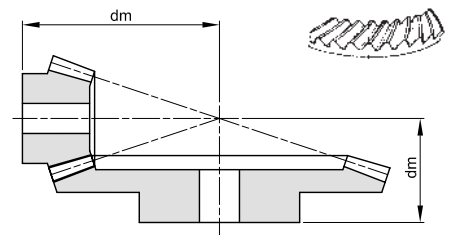
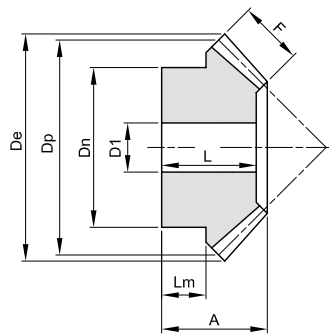

RUOTA MINORE CON ELICA SINISTRORSA
RUOTA MAGGIORE CON ELICA DESTROSA

Materiale: Acciaio C45

modulo	denti	codice	De	Dp	A	F	Dn	D1	dm	L	Lm	Kg.
2	16	463020016	36,5	32	25,7	15	25	12	59	24,0	9,7	0,09
2	48	463020048	96,6	96	25,3	15	50	15	36	21,5	13	0,62
2,5	16	463025016	45,7	40	27,7	18	33	14	70	26,0	8,9	0,17
2,5	48	463025048	120,8	120	31,4	18	60	20	45	26,5	16	1,19
3	16	463030016	54,8	48	29,9	18	42	15	84	28,0	11	0,29
3	48	463030048	145,0	144	36,7	18	65	20	54	31,0	19	1,91
3,5	16	463035016	63,9	56	36,8	22	48	15	99	34,0	13,6	0,48
3,5	48	463035048	169,1	168	43,1	22	75	20	63	36,0	23	2,31
4	16	463040016	73,1	64	41,8	25	55	20	113	39,0	15,5	0,70
4	48	463040048	193,3	192	49,2	25	85	22	72	41,0	27	4,21
4,5	16	463045016	82,2	72	53,8	28	60	20	134	50,0	24	1,14
4,5	48	463045048	217,4	216	56,3	28	90	25	82	47,5	27	7,03
5	16	463050016	91,4	80	60,5	35	60	20	146	57,0	22,7	1,45
5	48	463050048	241,6	240	63,5	35	100	28	91	53,5	35	8,42



RUOTE DENTATE CONICHE DENTI SPIROIDALI CONICAL SPIRAL TOOTHED GEARS

RAPPORTO 1:4

ANGOLO DI PRESSIONE **20°**

ANGOLO FRA GLI ALBERI $\Sigma = 90^\circ$

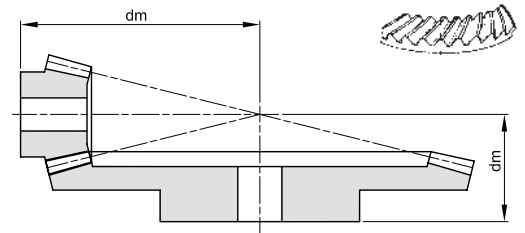
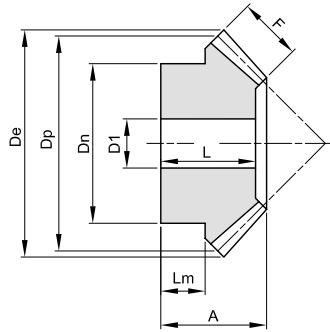

RUOTA MINORE CON ELICA SINISTRORSA
RUOTA MAGGIORE CON ELICA DESTROSA

Materiale: Acciaio C45

modulo	denti	codice	De	Dp	A	F	Dn	D1	dm	L	Lm	Kg.
2	16	464020016	36,7	32	24	15	25	12	73	23,0	8,2	0,09
2	64	464020064	128,5	128	27,3	15	70	20	39	23,0	14	1,30
2,5	16	464025016	45,9	40	31	18	34	15	93	29,0	12,2	0,20
2,5	64	464025064	160,6	160	34,2	18	80	20	49	29,0	16	2,59
3	16	464030016	55,1	48	32,1	20	40	15	108	30,0	11	0,31
3	64	464030064	192,7	192	40,9	20	90	20	59	35,0	22	3,94





PULEGGE DENTATE PER CINGHIE POSITIVE - ISO 5294 TIMING BELT PULLEYS - ISO 5294

MXL 025

PASSO 0,80" (2,032 mm)

PER CINGHIE LARGHEZZA 1/4" (6,35 mm)

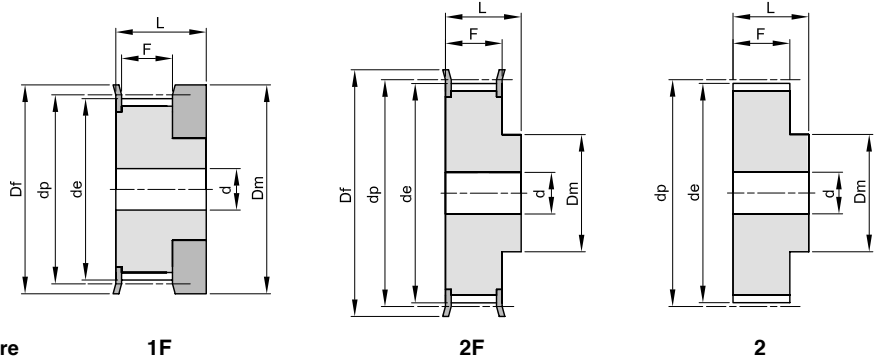

Materiale: Alluminio UNI 9006 - T6 (Al)
adatto per l'ossidazione dura a spessore

descrizione	codice	tipo	materiale	denti	dp	de	Df	Dm	F	L	d	n° flangia	Kg.
16 MXL 025	12025016	1F	Al	16	10,35	9,84	15	15	8,5	16		101	0,01
18 MXL 025	12025018	1F	Al	18	11,64	11,13	16	16	8,5	16		102	0,01
20 MXL 025	12025020	1F	Al	20	12,94	12,43	16	16	8,5	16		102	0,01
22 MXL 025	12025022	2F	Al	22	14,23	13,72	18	10	11	16		104	0,01
24 MXL 025	12025024	2F	Al	24	15,52	15,02	18	10	11	16		104	0,01
28 MXL 025	12025028	2F	Al	28	18,11	17,60	23	11	11	16		107	0,01
30 MXL 025	12025030	2F	Al	30	19,40	18,90	23	12	11	16		107	0,02
32 MXL 025	12025032	2F	Al	32	20,70	20,19	25	14	11	16		108	0,02
36 MXL 025	12025036	2F	Al	36	23,29	22,78	28	16	11	16		109	0,02
40 MXL 025	12025040	2F	Al	40	25,87	25,36	32	18	11	16		110	0,03
42 MXL 025	12025042	2F	Al	42	27,17	26,66	32	18	11	16		110	0,03
44 MXL 025	12025044	2F	Al	44	28,46	27,95	36	18	11	16		111	0,03
48 MXL 025	12025048	2	Al	48	31,05	30,54		20	11	16			0,03
60 MXL 025	12025060	2	Al	60	38,81	38,30		24	11	16			0,04
72 MXL 025	12025072	2	Al	72	46,57	46,06		25	11	16	6		0,05



PULEGGE DENTATE PER CINGHIE POSITIVE - ISO 5294

TIMING BELT PULLEYS - ISO 5294

XL 037

PASSO 1/5" (5,08 mm)

PER CINGHIE LARGHEZZA 3/8" (9,52 mm)

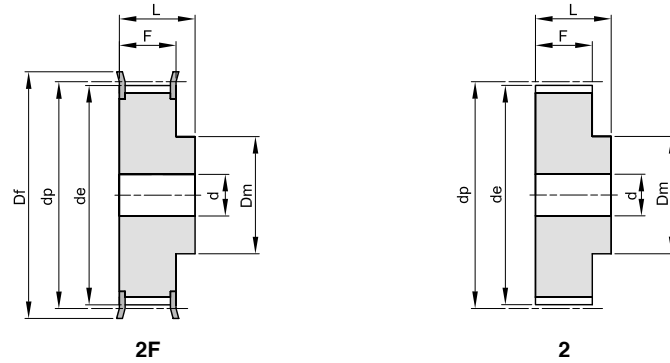

Materiale: Alluminio UNI 9006 - T6 (Al)
adatto per l'ossidazione dura a spessore

descrizione	codice	tipo	materiale	denti	dp	de	Df	Dm	F	L	d	n° flangia	Kg.
10 XL 037	13037010	2F	Al	10	16,17	15,66	23	10	14,3	20		201	0,01
11 XL 037	13037011	2F	Al	11	17,79	17,28	23	10	14,3	20		201	0,01
12 XL 037	13037012	2F	Al	12	19,40	18,90	25	10	14,3	20		203	0,01
13 XL 037	13037013	2F	Al	13	21,02	20,51	25	10	14,3	20		203	0,01
14 XL 037	13037014	2F	Al	14	22,64	22,13	28	16	14,3	20		204	0,02
15 XL 037	13037015	2F	Al	15	24,25	23,75	28	16	14,3	20		204	0,02
16 XL 037	13037016	2F	Al	16	25,87	25,36	32	16	14,3	20		205	0,03
17 XL 037	13037017	2F	Al	17	27,49	26,98	32	20	14,3	20		205	0,03
18 XL 037	13037018	2F	Al	18	29,11	28,60	36	20	14,3	20		206	0,04
19 XL 037	13037019	2F	Al	19	30,72	30,21	36	20	14,3	22		206	0,04
20 XL 037	13037020	2F	Al	20	32,34	31,83	38	25	14,3	22		207	0,05
21 XL 037	13037021	2F	Al	21	33,96	33,45	38	25	14,3	22		207	0,05
22 XL 037	13037022	2F	Al	22	35,57	35,07	42	25	14,3	22		208	0,06
24 XL 037	13037024	2F	Al	24	38,81	38,30	44	30	14,3	22		209	0,06
26 XL 037	13037026	2F	Al	26	42,04	41,53	48	30	14,3	22	8	210	0,09
27 XL 037	13037027	2F	Al	27	43,66	43,15	48	34	14,3	22	8	210	0,09
28 XL 037	13037028	2F	Al	28	45,28	44,77	51	34	14,3	22	8	211	0,10
30 XL 037	13037030	2F	Al	30	48,51	48,00	54	38	14,3	22	8	212	0,12
32 XL 037	13037032	2F	Al	32	51,74	51,24	57	38	14,3	25	8	213	0,12
34 XL 037	13037034	2F	Al	34	54,98	54,47	60	38	14,3	25	8	214	0,13
35 XL 037	13037035	2F	Al	35	56,60	56,09	63	38	14,3	25	8	215	0,14
36 XL 037	13037036	2	Al	36	58,21	57,70		45	14,3	25	8		0,14
38 XL 037	13037038	2	Al	38	61,45	60,94		45	14,3	25	8		0,15
40 XL 037	13037040	2	Al	40	64,68	64,17		45	14,3	25	8		0,16
42 XL 037	13037042	2	Al	42	67,91	67,41		45	14,3	25	8		0,18
44 XL 037	13037044	2	Al	44	71,15	70,64		45	14,3	25	8		0,19
48 XL 037	13037048	2	Al	48	77,62	77,11		45	14,3	25	10		0,19
52 XL 037	13037052	2	Al	52	84,08	83,57		45	14,3	25	10		0,19
60 XL 037	13037060	2	Al	60	97,02	96,51		45	14,3	25	10		0,22
72 XL 037	13037072	2	Al	72	116,42	115,92		45	14,3	25	10		0,44



PULEGGE DENTATE PER CINGHIE POSITIVE - ISO 5294

TIMING BELT PULLEYS - ISO 5294

L 050

PASSO 3/8" (9,525 mm)

PER CINGHIE LARGHEZZA 1/2" (12,7 mm)

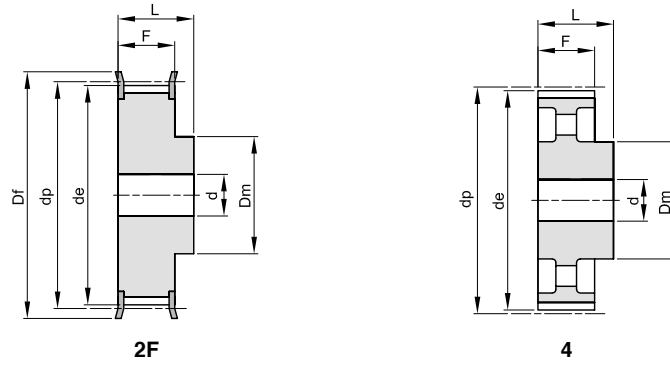

Materiale: Acciaio (St)
Materiale: Ghisa (GG)

descrizione	codice	tipo	materiale	denti	dp	de	Df	Dm	F	L	d	n° flangia	Kg.
10 L 050	14050010	2F	St	10	30,32	29,56	36	20	19,0	28	8	300	0,11
11 L 050	14050011	2F	St	11	33,35	32,59	38	24	19,0	30	8	301	0,14
12 L 050	14050012	2F	St	12	36,38	35,62	42	24	19,0	30	8	302	0,17
13 L 050	14050013	2F	St	13	39,41	38,65	44	28	19,0	30	8	303	0,21
14 L 050	14050014	2F	St	14	42,44	41,68	48	28	19,0	30	8	304	0,24
15 L 050	14050015	2F	St	15	45,48	44,72	51	34	19,0	30	8	305	0,29
16 L 050	14050016	2F	St	16	48,51	47,75	54	36	19,0	32	8	306	0,33
17 L 050	14050017	2F	St	17	51,54	50,78	57	36	19,0	32	10	307	0,38
18 L 050	14050018	2F	St	18	54,57	53,81	60	40	19,0	32	10	308	0,44
19 L 050	14050019	2F	St	19	57,61	56,84	63	40	19,0	32	10	309	0,47
20 L 050	14050020	2F	St	20	60,64	59,88	66	40	19,0	32	10	310	0,51
21 L 050	14050021	2F	St	21	63,67	62,91	71	45	19,0	32	10	311	0,60
22 L 050	14050022	2F	St	22	66,70	65,94	75	45	19,0	32	10	312	0,64
23 L 050	14050023	2F	St	23	69,73	68,97	79	55	19,0	32	10	313	0,78
24 L 050	14050024	2F	St	24	72,77	72,00	79	55	19,0	32	10	313	0,81
25 L 050	14050025	2F	St	25	75,80	75,04	83	58	19,0	32	10	314	0,89
26 L 050	14050026	2F	St	26	78,83	78,07	87	58	19,0	32	12	315	0,94
27 L 050	14050027	2F	St	27	81,86	81,10	87	58	19,0	32	12	315	0,99
28 L 050	14050028	2F	St	28	84,89	84,13	91	58	19,0	32	12	316	1,04
30 L 050	14050030	2F	St	30	90,96	90,20	97	70	19,0	32	12	318	1,27
32 L 050	14050032	2F	St	32	97,03	96,26	103	70	19,0	32	12	320	1,41
33 L 050	14050033	2F	St	33	100,05	99,29	106	70	19,0	32	12	321	1,49
34 L 050	14050034	2F	St	34	103,08	102,32	111	70	19,0	32	12	322	1,57
35 L 050	14050035	2F	St	35	106,12	105,35	111	70	19,0	32	12	322	1,62
36 L 050	14050036	2F	St	36	109,15	108,39	115	70	19,0	32	12	323	1,70
40 L 050	14050040	2F	St	40	121,29	120,51	127	70	19,0	32	12	327	2,03
42 L 050	14050042	2F	St	42	127,34	126,58	135	70	19,0	32	12	328	2,21
44 L 050	14050044	2F	St	44	133,40	132,64	140	70	19,0	32	12	330	2,38
45 L 050	14050045	2F	St	45	136,44	135,67	143	70	19,0	32	12	331	2,48
48 L 050	14050048	2F	St	48	145,53	144,77	152	70	19,0	32	12	334	2,78
50 L 050	14050050	4	GG	50	151,60	150,83		70	19,0	32	14		1,74
52 L 050	14050052	4	GG	52	157,66	156,90		70	19,0	32	14		1,80
56 L 050	14050056	4	GG	56	169,79	169,02		70	19,0	32	14		1,87
57 L 050	14050057	4	GG	57	172,82	172,06		70	19,0	32	14		1,88
60 L 050	14050060	4	GG	60	181,91	181,15		75	19,0	42	14		2,41
72 L 050	14050072	4	GG	72	218,29	217,53		75	19,0	42	14		2,82
84 L 050	14050084	4	GG	84	254,68	253,92		75	19,0	42	14		3,08
96 L 050	14050096	4	GG	96	291,06	290,30		75	19,0	42	14		3,42



PULEGGE DENTATE PER CINGHIE POSITIVE - ISO 5294

TIMING BELT PULLEYS - ISO 5294

L 075

PASSO 3/8" (9,525 mm)

PER CINGHIE LARGHEZZA 3/4" (19,05 mm)

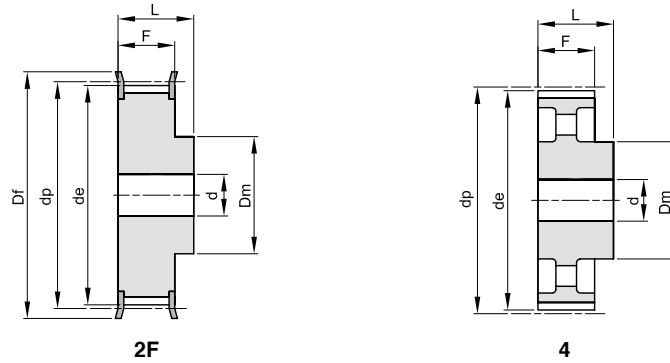

Materiale: Acciaio (St)
Materiale: Ghisa (GG)

descrizione	codice	tipo	materiale	denti	dp	de	Df	Dm	F	L	d	n° flangia	Kg.
10 L 075	14075010	2F	St	10	30,32	29,56	36	20	25,4	38	8	300	0,14
11 L 075	14075011	2F	St	11	33,35	32,59	38	24	25,4	38	8	301	0,18
12 L 075	14075012	2F	St	12	36,38	35,62	42	24	25,4	38	8	302	0,22
13 L 075	14075013	2F	St	13	39,41	38,65	44	28	25,4	38	8	303	0,26
14 L 075	14075014	2F	St	14	42,44	41,68	48	28	25,4	38	8	304	0,30
15 L 075	14075015	2F	St	15	45,48	44,72	51	34	25,4	38	8	305	0,37
16 L 075	14075016	2F	St	16	48,51	47,75	54	36	25,4	38	8	306	0,43
17 L 075	14075017	2F	St	17	51,54	50,78	57	36	25,4	38	10	307	0,46
18 L 075	14075018	2F	St	18	54,57	53,81	60	40	25,4	38	10	308	0,54
19 L 075	14075019	2F	St	19	57,61	56,84	63	40	25,4	38	10	309	0,58
20 L 075	14075020	2F	St	20	60,64	59,88	66	40	25,4	38	10	310	0,64
21 L 075	14075021	2F	St	21	63,67	62,91	71	45	25,4	38	10	311	0,71
22 L 075	14075022	2F	St	22	66,70	65,94	75	45	25,4	38	10	312	0,79
23 L 075	14075023	2F	St	23	69,73	68,97	79	55	25,4	38	10	313	0,94
24 L 075	14075024	2F	St	24	72,77	72,00	79	55	25,4	38	10	313	1,00
25 L 075	14075025	2F	St	25	75,80	75,04	83	58	25,4	38	10	314	1,10
26 L 075	14075026	2F	St	26	78,83	78,07	87	58	25,4	38	12	315	1,16
27 L 075	14075027	2F	St	27	81,86	81,10	87	58	25,4	38	12	315	1,22
28 L 075	14075028	2F	St	28	84,89	84,13	91	58	25,4	38	12	316	1,30
30 L 075	14075030	2F	St	30	90,96	90,20	97	70	25,4	38	12	318	1,47
32 L 075	14075032	2F	St	32	97,03	96,26	103	70	25,4	38	12	320	1,75
33 L 075	14075033	2F	St	33	100,05	99,29	106	70	25,4	38	12	321	1,85
34 L 075	14075034	2F	St	34	103,08	102,32	111	70	25,4	38	12	322	1,93
35 L 075	14075035	2F	St	35	106,12	105,35	111	70	25,4	38	12	322	2,03
36 L 075	14075036	2F	St	36	109,15	108,39	115	70	25,4	38	12	323	2,14
40 L 075	14075040	2F	St	40	121,29	120,51	127	70	25,4	38	12	327	2,56
42 L 075	14075042	2F	St	42	127,34	126,58	135	70	25,4	38	12	328	2,81
44 L 075	14075044	2F	St	44	133,40	132,64	140	70	25,4	38	12	330	3,02
45 L 075	14075045	2F	St	45	136,44	135,67	143	70	25,4	38	12	331	3,16
48 L 075	14075048	2F	St	48	145,53	144,77	152	70	25,4	38	12	334	3,57
50 L 075	14075050	4	GG	50	151,60	150,83		70	25,4	38	14		2,10
52 L 075	14075052	4	GG	52	157,66	156,90		70	25,4	38	14		2,13
56 L 075	14075056	4	GG	56	169,79	169,02		70	25,4	38	14		2,27
57 L 075	14075057	4	GG	57	172,82	172,06		70	25,4	38	14		2,28
60 L 075	14075060	4	GG	60	181,91	181,15		75	25,4	45	14		2,70
72 L 075	14075072	4	GG	72	218,29	217,53		75	25,4	45	14		3,19
84 L 075	14075084	4	GG	84	254,68	253,92		75	25,4	45	14		3,64
96 L 075	14075096	4	GG	96	291,06	290,30		75	25,4	45	14		4,04



PULEGGE DENTATE PER CINGHIE POSITIVE - ISO 5294

TIMING BELT PULLEYS - ISO 5294

L 100

PASSO 3/8" (9,525 mm)

PER CINGHIE LARGHEZZA 1" (25,4 mm)

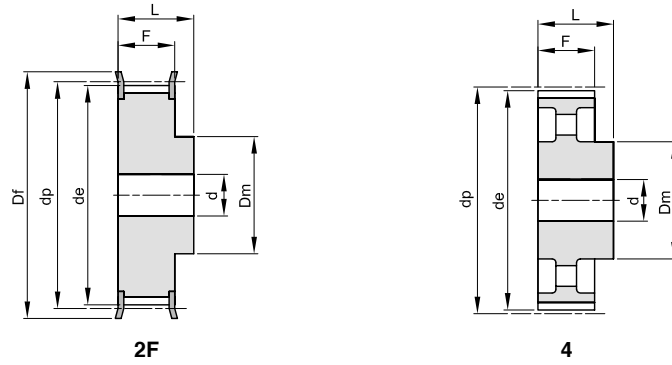

Materiale: Acciaio (St)
Materiale: Ghisa (GG)

descrizione	codice	tipo	materiale	denti	dp	de	Df	Dm	F	L	d	n° flangia	Kg.
10 L 100	14100010	2F	St	10	30,32	29,56	36	20	31,8	45	8	300	0,17
11 L 100	14100011	2F	St	11	33,35	32,59	38	24	31,8	45	8	301	0,22
12 L 100	14100012	2F	St	12	36,38	35,62	42	24	31,8	45	8	302	0,26
13 L 100	14100013	2F	St	13	39,41	38,65	44	28	31,8	45	8	303	0,32
14 L 100	14100014	2F	St	14	42,44	41,68	48	28	31,8	45	10	304	0,35
15 L 100	14100015	2F	St	15	45,48	44,72	51	34	31,8	45	10	305	0,43
16 L 100	14100016	2F	St	16	48,51	47,75	54	36	31,8	45	10	306	0,50
17 L 100	14100017	2F	St	17	51,54	50,78	57	36	31,8	45	10	307	0,56
18 L 100	14100018	2F	St	18	54,57	53,81	60	40	31,8	45	10	308	0,64
19 L 100	14100019	2F	St	19	57,61	56,84	63	40	31,8	45	10	309	0,70
20 L 100	14100020	2F	St	20	60,64	59,88	66	40	31,8	45	10	310	0,77
21 L 100	14100021	2F	St	21	63,67	62,91	71	45	31,8	45	10	311	0,88
22 L 100	14100022	2F	St	22	66,70	65,94	75	45	31,8	45	12	312	0,95
23 L 100	14100023	2F	St	23	69,73	68,97	79	55	31,8	45	12	313	1,11
24 L 100	14100024	2F	St	24	72,77	72,00	79	55	31,8	45	12	313	1,18
25 L 100	14100025	2F	St	25	75,80	75,04	83	58	31,8	45	12	314	1,30
26 L 100	14100026	2F	St	26	78,83	78,07	87	58	31,8	45	12	315	1,40
27 L 100	14100027	2F	St	27	81,86	81,10	87	58	31,8	45	12	315	1,47
28 L 100	14100028	2F	St	28	84,89	84,13	91	58	31,8	45	12	316	1,58
30 L 100	14100030	2F	St	30	90,96	90,20	97	70	31,8	45	12	318	1,78
32 L 100	14100032	2F	St	32	97,03	96,26	103	70	31,8	45	12	320	2,11
33 L 100	14100033	2F	St	33	100,05	99,29	106	70	31,8	45	12	321	2,23
34 L 100	14100034	2F	St	34	103,08	102,32	111	70	31,8	45	12	322	2,39
35 L 100	14100035	2F	St	35	106,12	105,35	111	70	31,8	45	12	322	2,45
36 L 100	14100036	2F	St	36	109,15	108,39	115	70	31,8	45	12	323	2,59
40 L 100	14100040	2F	St	40	121,29	120,51	127	70	31,8	45	12	327	3,13
42 L 100	14100042	2F	St	42	127,34	126,58	135	70	31,8	45	12	328	3,43
44 L 100	14100044	2F	St	44	133,40	132,64	140	70	31,8	45	12	330	3,72
45 L 100	14100045	2F	St	45	136,44	135,67	143	70	31,8	45	12	331	3,89
48 L 100	14100048	2F	St	48	145,53	144,77	152	70	31,8	45	12	334	4,38
50 L 100	14100050	4	GG	50	151,60	150,83		70	31,8	45	14		2,41
52 L 100	14100052	4	GG	52	157,66	156,90		70	31,8	45	14		2,55
56 L 100	14100056	4	GG	56	169,79	169,02		70	31,8	45	14		2,65
57 L 100	14100057	4	GG	57	172,82	172,06		70	31,8	45	14		2,71
60 L 100	14100060	4	GG	60	181,91	181,15		75	31,8	45	14		3,11
72 L 100	14100072	4	GG	72	218,29	217,53		75	31,8	45	14		3,65
84 L 100	14100084	4	GG	84	254,68	253,92		75	31,8	45	14		4,12
96 L 100	14100096	4	GG	96	291,06	290,30		75	31,8	45	14		4,60



PULEGGE DENTATE PER CINGHIE POSITIVE - ISO 5294

TIMING BELT PULLEYS - ISO 5294

H 075

PASSO 1/2" (12,7 mm)

PER CINGHIE LARGHEZZA 3/4" (19,05 mm)

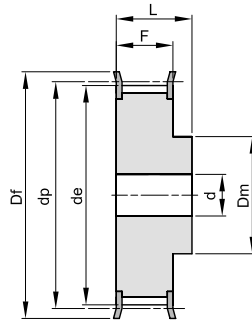

2F

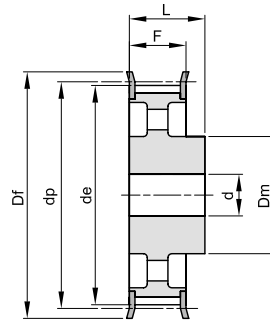

4F

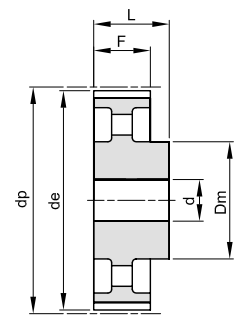

4

Materiale: Acciaio (St)
Materiale: Ghisa (GG)

descrizione	codice	tipo	materiale	denti	dp	de	Df	Dm	F	L	d	n° flangia	Kg.
14 H 075	15075014	2F	St	14	56,59	55,22	63	40	26,4	40	10	309	0,58
15 H 075	15075015	2F	St	15	60,64	59,27	66	45	26,4	40	10	310	0,69
16 H 075	15075016	2F	St	16	64,68	63,31	71	45	26,4	40	10	311	0,77
17 H 075	15075017	2F	St	17	68,72	67,35	75	45	26,4	40	12	312	0,84
18 H 075	15075018	2F	St	18	72,77	71,39	79	55	26,4	40	12	313	1,01
19 H 075	15075019	2F	St	19	76,81	75,44	83	60	26,4	40	12	314	1,15
20 H 075	15075020	2F	St	20	80,85	79,48	87	62	26,4	40	12	315	1,27
21 H 075	15075021	2F	St	21	84,89	83,52	91	65	26,4	40	12	316	1,41
22 H 075	15075022	2F	St	22	88,94	87,56	93	68	26,4	40	12	317	1,55
23 H 075	15075023	2F	St	23	92,98	91,61	97	72	26,4	40	12	318	1,71
24 H 075	15075024	2F	St	24	97,03	95,65	103	72	26,4	40	12	320	1,83
25 H 075	15075025	2F	St	25	101,06	99,69	106	72	26,4	40	12	321	1,96
26 H 075	15075026	2F	St	26	105,11	103,73	111	80	26,4	40	12	322	2,19
27 H 075	15075027	2F	St	27	109,15	107,78	115	80	26,4	40	12	323	2,32
28 H 075	15075028	2F	St	28	113,19	111,82	119	80	26,4	40	12	325	2,47
30 H 075	15075030	2F	St	30	121,29	119,90	127	80	26,4	40	14	327	2,76
32 H 075	15075032	2F	St	32	129,36	127,99	135	80	26,4	40	14	328	3,08
33 H 075	15075033	2F	St	33	133,40	132,03	140	80	26,4	40	14	330	3,25
34 H 075	15075034	2F	St	34	137,45	136,07	143	80	26,4	40	14	331	3,42
35 H 075	15075035	2F	St	35	141,49	140,12	148	80	26,4	40	14	333	3,61
36 H 075	15075036	2F	St	36	145,53	144,16	152	80	26,4	40	14	334	3,79
38 H 075	15075038	2F	St	38	153,62	152,24	158	80	26,4	40	14	335	4,16
40 H 075	15075040	2F	St	40	161,70	160,33	168	80	26,4	40	14	338	4,58
44 H 075	15075044	4F	GG	44	177,87	176,50	184	80	26,4	40	18	339	2,57
48 H 075	15075048	4F	GG	48	194,04	192,67	200	90	26,4	45	18	342	3,56
50 H 075	15075050	4	GG	50	202,13	200,75		90	26,4	45	18		3,74



PULEGGE DENTATE PER CINGHIE POSITIVE - ISO 5294

TIMING BELT PULLEYS - ISO 5294

H 100

PASSO 1/2" (12,7 mm)

PER CINGHIE LARGHEZZA 1" (25,4 mm)

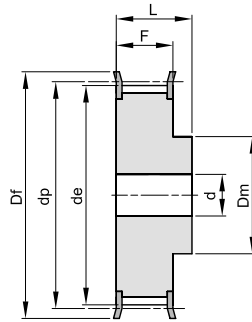

2F

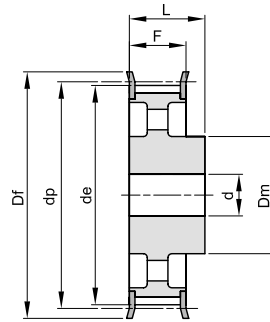

4F

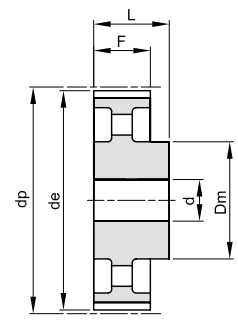

4

Materiale: Acciaio (St)
Materiale: Ghisa (GG)

descrizione	codice	tipo	materiale	denti	dp	de	Df	Dm	F	L	d	n° flangia	Kg.
14 H 100	15100014	2F	St	14	56,59	55,22	63	40	31,8	45	12	309	0,65
15 H 100	15100015	2F	St	15	60,64	59,27	66	45	31,8	45	12	310	0,77
16 H 100	15100016	2F	St	16	64,68	63,31	71	45	31,8	45	12	311	0,87
17 H 100	15100017	2F	St	17	68,72	67,35	75	45	31,8	45	12	312	0,97
18 H 100	15100018	2F	St	18	72,77	71,39	79	55	31,8	45	12	313	1,16
19 H 100	15100019	2F	St	19	76,81	75,44	83	60	31,8	45	14	314	1,30
20 H 100	15100020	2F	St	20	80,85	79,48	87	62	31,8	45	14	315	1,44
21 H 100	15100021	2F	St	21	84,89	83,52	91	65	31,8	45	14	316	1,60
22 H 100	15100022	2F	St	22	88,94	87,56	93	68	31,8	45	14	317	1,76
23 H 100	15100023	2F	St	23	92,98	91,61	97	72	31,8	45	14	318	1,94
24 H 100	15100024	2F	St	24	97,03	95,65	103	72	31,8	45	14	320	2,09
25 H 100	15100025	2F	St	25	101,06	99,69	106	72	31,8	45	14	321	2,24
26 H 100	15100026	2F	St	26	105,11	103,73	111	80	31,8	45	14	322	2,49
27 H 100	15100027	2F	St	27	109,15	107,78	115	80	31,8	45	14	323	2,66
28 H 100	15100028	2F	St	28	113,19	111,82	119	80	31,8	45	14	325	2,83
29 H 100	15100029	2F	St	29	117,23	115,86	123	80	31,8	45	14	326	3,01
30 H 100	15100030	2F	St	30	121,29	119,90	127	80	31,8	45	14	327	3,19
32 H 100	15100032	2F	St	32	129,36	127,99	135	80	31,8	45	14	328	3,57
33 H 100	15100033	2F	St	33	133,40	132,03	140	80	31,8	45	14	330	3,79
34 H 100	15100034	2F	St	34	137,45	136,07	143	80	31,8	45	14	331	3,99
35 H 100	15100035	2F	St	35	141,49	140,12	148	80	31,8	45	14	333	4,20
36 H 100	15100036	2F	St	36	145,53	144,16	152	80	31,8	45	14	334	4,44
38 H 100	15100038	2F	St	38	153,62	152,24	158	80	31,8	45	14	335	4,90
40 H 100	15100040	2F	St	40	161,70	160,33	168	80	31,8	45	14	338	5,39
44 H 100	15100044	4F	GG	44	177,87	176,50	184	80	31,8	50	18	339	3,37
45 H 100	15100045	4F	GG	45	181,91	180,54	192	80	31,8	50	18	340	3,57
48 H 100	15100048	4F	GG	48	194,04	192,67	200	90	31,8	50	18	342	4,10
50 H 100	15100050	4	GG	50	202,13	200,75		90	31,8	50	18		4,24
52 H 100	15100052	4	GG	52	210,21	208,84		90	31,8	50	18		4,32
58 H 100	15100058	4	GG	58	234,47	233,09		90	31,8	50	18		4,61
60 H 100	15100060	4	GG	60	242,55	241,18		100	31,8	50	18		5,30
70 H 100	15100070	4	GG	70	282,98	281,61		100	31,8	55	18		6,13
72 H 100	15100072	4	GG	72	291,06	289,69		120	31,8	55	18		7,47
84 H 100	15100084	4	GG	84	339,57	338,20		120	31,8	55	18		8,52
96 H 100	15100096	4	GG	96	388,08	386,71		120	31,8	60	18		10,25
120 H 100	15100120	4	GG	120	485,10	483,73		120	31,8	60	18		13,09



PULEGGE DENTATE PER CINGHIE POSITIVE - ISO 5294

TIMING BELT PULLEYS - ISO 5294

H 150

PASSO 1/2" (12,7 mm)

PER CINGHIE LARGHEZZA 1 1/2 (38,1 mm)

Materiale: Acciaio (St)
Materiale: Ghisa (GG)

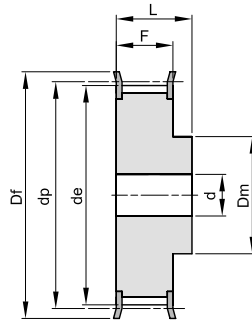

2F

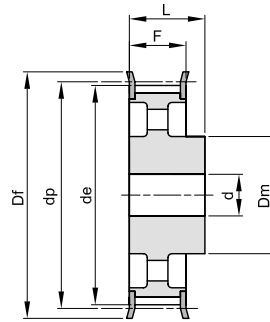

4F

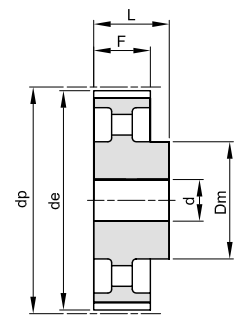

4

descrizione	codice	tipo	materiale	denti	dp	de	Df	Dm	F	L	d	n° flangia	Kg.
14 H 150	15150014	2F	St	14	56,59	55,22	63	40	46,0	58	18	309	0,81
15 H 150	15150015	2F	St	15	60,64	59,27	66	45	46,0	58	18	310	0,97
16 H 150	15150016	2F	St	16	64,68	63,31	71	45	46,0	58	18	311	1,11
17 H 150	15150017	2F	St	17	68,72	67,35	75	45	46,0	58	18	312	1,25
18 H 150	15150018	2F	St	18	72,77	71,39	79	55	46,0	58	18	313	1,48
19 H 150	15150019	2F	St	19	76,81	75,44	83	60	46,0	58	18	314	1,68
20 H 150	15150020	2F	St	20	80,85	79,48	87	62	46,0	58	18	315	1,88
21 H 150	15150021	2F	St	21	84,89	83,52	91	65	46,0	58	18	316	2,08
22 H 150	15150022	2F	St	22	88,94	87,56	93	68	46,0	58	18	317	2,30
23 H 150	15150023	2F	St	23	92,98	91,61	97	72	46,0	58	18	318	2,54
24 H 150	15150024	2F	St	24	97,03	95,65	103	72	46,0	58	18	320	2,75
25 H 150	15150025	2F	St	25	101,06	99,69	106	72	46,0	58	18	321	2,97
26 H 150	15150026	2F	St	26	105,11	103,73	111	80	46,0	58	18	322	3,29
27 H 150	15150027	2F	St	27	109,15	107,78	115	80	46,0	58	18	323	3,52
28 H 150	15150028	2F	St	28	113,19	111,82	119	80	46,0	58	18	325	3,78
29 H 150	15150029	2F	St	29	117,23	115,86	123	80	46,0	58	18	326	4,03
30 H 150	15150030	2F	St	30	121,29	119,90	127	80	46,0	58	18	327	4,29
32 H 150	15150032	2F	St	32	129,36	127,99	135	80	46,0	58	18	328	4,86
33 H 150	15150033	2F	St	33	133,40	132,03	140	80	46,0	58	18	330	5,15
34 H 150	15150034	2F	St	34	137,45	136,07	143	80	46,0	58	18	331	5,46
35 H 150	15150035	2F	St	35	141,49	140,12	148	80	46,0	58	18	333	5,78
36 H 150	15150036	2F	St	36	145,53	144,16	152	80	46,0	58	18	334	6,09
38 H 150	15150038	2F	St	38	153,62	152,24	158	80	46,0	58	18	335	6,74
40 H 150	15150040	2F	St	40	161,70	160,33	168	80	46,0	58	18	338	7,46
44 H 150	15150044	4F	GG	44	177,87	176,50	184	80	46,0	58	18	339	4,29
45 H 150	15150045	4F	GG	45	181,91	180,54	192	80	46,0	58	18	340	4,44
48 H 150	15150048	4F	GG	48	194,04	192,67	200	90	46,0	65	18	342	5,41
50 H 150	15150050	4	GG	50	202,13	200,75		90	46,0	65	18		5,59
52 H 150	15150052	4	GG	52	210,21	208,84		90	46,0	65	18		5,79
58 H 150	15150058	4	GG	58	234,47	233,09		90	46,0	65	18		6,15
60 H 150	15150060	4	GG	60	242,55	241,18		100	46,0	65	18		7,08
70 H 150	15150070	4	GG	70	282,98	281,61		100	46,0	65	24		7,77
72 H 150	15150072	4	GG	72	291,06	289,69		120	46,0	65	24		9,70
84 H 150	15150084	4	GG	84	339,57	338,20		120	46,0	65	24		10,99
96 H 150	15150096	4	GG	96	388,08	386,71		120	46,0	65	24		12,24
120 H 150	15150120	4	GG	120	485,10	483,73		120	46,0	65	24		16,17



PULEGGE DENTATE PER CINGHIE POSITIVE - ISO 5294

TIMING BELT PULLEYS - ISO 5294

H 200

PASSO 1/2" (12,7 mm)

PER CINGHIE LARGHEZZA 2" (50,8 mm)

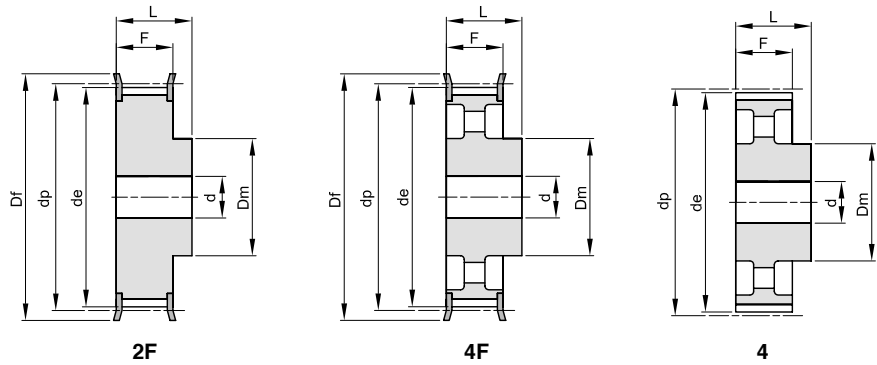

Materiale: Acciaio (St)
Materiale: Ghisa (GG)

descrizione	codice	tipo	materiale	denti	dp	de	Df	Dm	F	L	d	n° flangia	Kg.
14 H 200	15200014	2F	St	14	56,59	55,22	63	40	58,7	70	18	309	1,10
15 H 200	15200015	2F	St	15	60,64	59,27	66	45	58,7	70	18	310	1,33
16 H 200	15200016	2F	St	16	64,68	63,31	71	45	58,7	70	18	311	1,54
17 H 200	15200017	2F	St	17	68,72	67,35	75	45	58,7	70	18	312	1,69
18 H 200	15200018	2F	St	18	72,77	71,39	79	55	58,7	70	18	313	1,95
19 H 200	15200019	2F	St	19	76,81	75,44	83	60	58,7	70	18	314	2,20
20 H 200	15200020	2F	St	20	80,85	79,48	87	62	58,7	70	18	315	2,44
21 H 200	15200021	2F	St	21	84,89	83,52	91	65	58,7	70	18	316	2,70
22 H 200	15200022	2F	St	22	88,94	87,56	93	68	58,7	70	18	317	2,97
23 H 200	15200023	2F	St	23	92,98	91,61	97	72	58,7	70	18	318	3,25
24 H 200	15200024	2F	St	24	97,03	95,65	103	72	58,7	70	18	320	3,56
25 H 200	15200025	2F	St	25	101,06	99,69	106	72	58,7	70	18	321	3,81
26 H 200	15200026	2F	St	26	105,11	103,73	111	80	58,7	70	18	322	4,18
27 H 200	15200027	2F	St	27	109,15	107,78	115	80	58,7	70	18	323	4,49
28 H 200	15200028	2F	St	28	113,19	111,82	119	80	58,7	70	18	325	4,81
29 H 200	15200029	2F	St	29	117,23	115,86	123	80	58,7	70	18	326	5,14
30 H 200	15200030	2F	St	30	121,29	119,90	127	80	58,7	70	18	327	5,47
32 H 200	15200032	2F	St	32	129,36	127,99	135	80	58,7	70	18	328	6,17
33 H 200	15200033	2F	St	33	133,40	132,03	140	80	58,7	70	18	330	6,56
34 H 200	15200034	2F	St	34	137,45	136,07	143	80	58,7	70	18	331	6,94
35 H 200	15200035	2F	St	35	141,49	140,12	148	80	58,7	70	18	333	7,34
36 H 200	15200036	2F	St	36	145,53	144,16	152	80	58,7	70	18	334	7,75
38 H 200	15200038	2F	St	38	153,62	152,24	158	80	58,7	70	18	335	8,62
40 H 200	15200040	2F	St	40	161,70	160,33	168	80	58,7	70	18	338	9,50
44 H 200	15200044	4F	GG	44	177,87	176,50	184	80	58,7	70	18	339	5,14
45 H 200	15200045	4F	GG	45	181,91	180,54	192	80	58,7	70	18	340	5,38
48 H 200	15200048	4F	GG	48	194,04	192,67	200	90	58,7	75	24	342	6,29
50 H 200	15200050	4	GG	50	202,13	200,75		90	58,7	75	24		6,68
52 H 200	15200052	4	GG	52	210,21	208,84		90	58,7	75	24		6,81
58 H 200	15200058	4	GG	58	234,47	233,09		90	58,7	75	24		7,26
60 H 200	15200060	4	GG	60	242,55	241,18		100	58,7	75	24		8,25
70 H 200	15200070	4	GG	70	282,98	281,61		100	58,7	75	28		9,20
72 H 200	15200072	4	GG	72	291,06	289,69		120	58,7	75	28		11,09
84 H 200	15200084	4	GG	84	339,57	338,20		120	58,7	75	28		12,63
96 H 200	15200096	4	GG	96	388,08	386,71		120	58,7	75	28		14,51
120 H 200	15200120	4	GG	120	485,10	483,73		120	58,7	75	28		19,15



PULEGGE DENTATE PER CINGHIE POSITIVE - ISO 5294

TIMING BELT PULLEYS - ISO 5294

H 300

PASSO 1/2" (12,7 mm)

PER CINGHIE LARGHEZZA 3" (76,2 mm)

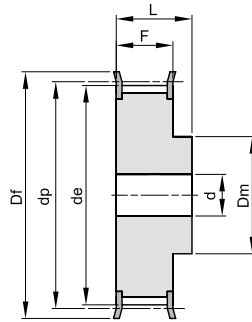

2F

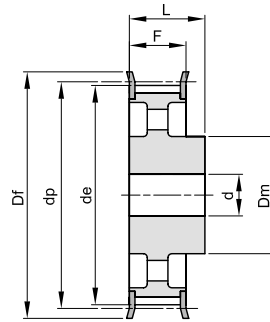

4F

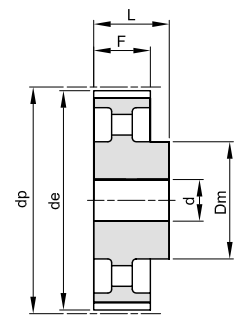

4

Materiale: Acciaio (St)
Materiale: Ghisa (GG)

descrizione	codice	tipo	materiale	denti	dp	de	Df	Dm	F	L	d	n° flangia	Kg.
14 H 300	15300014	2F	St	14	56,59	55,22	63	40	85,7	100	18	309	1,64
15 H 300	15300015	2F	St	15	60,64	59,27	66	45	85,7	100	18	310	1,91
16 H 300	15300016	2F	St	16	64,68	63,31	71	45	85,7	100	18	311	2,16
17 H 300	15300017	2F	St	17	68,72	67,35	75	45	85,7	100	18	312	2,43
18 H 300	15300018	2F	St	18	72,77	71,39	79	55	85,7	100	18	313	2,80
19 H 300	15300019	2F	St	19	76,81	75,44	83	60	85,7	100	18	314	3,16
20 H 300	15300020	2F	St	20	80,85	79,48	87	62	85,7	100	18	315	3,50
21 H 300	15300021	2F	St	21	84,89	83,52	91	65	85,7	100	18	316	3,87
22 H 300	15300022	2F	St	22	88,94	87,56	93	68	85,7	100	18	317	4,26
23 H 300	15300023	2F	St	23	92,98	91,61	97	72	85,7	100	18	318	4,68
24 H 300	15300024	2F	St	24	97,03	95,65	103	72	85,7	100	18	320	5,08
25 H 300	15300025	2F	St	25	101,06	99,69	106	72	85,7	100	18	321	5,45
26 H 300	15300026	2F	St	26	105,11	103,73	111	80	85,7	100	18	322	6,01
27 H 300	15300027	2F	St	27	109,15	107,78	115	80	85,7	100	18	323	6,45
28 H 300	15300028	2F	St	28	113,19	111,82	119	80	85,7	100	18	325	6,91
30 H 300	15300030	2F	St	30	121,29	119,90	127	80	85,7	100	18	327	7,90
32 H 300	15300032	2F	St	32	129,36	127,99	135	80	85,7	100	18	328	8,92
33 H 300	15300033	2F	St	33	133,40	132,03	140	80	85,7	100	18	330	9,46
34 H 300	15300034	2F	St	34	137,45	136,07	143	80	85,7	100	18	331	10,04
35 H 300	15300035	2F	St	35	141,49	140,12	148	80	85,7	100	18	333	10,62
36 H 300	15300036	2F	St	36	145,53	144,16	152	80	85,7	100	18	334	11,24
38 H 300	15300038	2F	St	38	153,62	152,24	158	80	85,7	100	18	335	12,44
40 H 300	15300040	2F	St	40	161,70	160,33	168	80	85,7	100	18	338	13,80
44 H 300	15300044	4F	GG	44	177,87	176,50	184	80	85,7	100	24	339	7,22
48 H 300	15300048	4F	GG	48	194,04	192,67	200	90	85,7	100	24	342	8,60
50 H 300	15300050	4	GG	50	202,13	200,75		90	85,7	100	24		8,99
58 H 300	15300058	4	GG	58	234,47	233,09		90	85,7	100	24		10,04
60 H 300	15300060	4	GG	60	242,55	241,18		100	85,7	100	24		11,18
72 H 300	15300072	4	GG	72	291,06	289,69		120	85,7	100	28		15,07
84 H 300	15300084	4	GG	84	339,57	338,20		120	85,7	100	28		16,97
96 H 300	15300096	4	GG	96	388,08	386,71		120	85,7	100	28		19,86
120 H 300	15300120	4	GG	120	485,10	483,73		120	85,7	100	28		25,91



PULEGGE DENTATE PER CINGHIE POSITIVE - ISO 5294 TIMING BELT PULLEYS - ISO 5294

XH 200

PASSO 7/8" (22,22 mm)

PER CINGHIE LARGHEZZA 2" (50,8 mm)

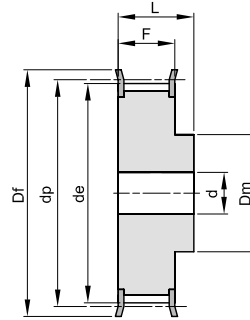

2F

Materiale: Acciaio (St)

descrizione	codice	tipo	materiale	denti	dp	de	Df	Dm	F	L	d	n° flangia	Kg.
18 XH 200	16200018	2F	St	18	127,34	124,55	138	100	65	80	24	401	6,00
19 XH 200	16200019	2F	St	19	134,41	131,62	146	100	65	80	24	402	6,60
20 XH 200	16200020	2F	St	20	141,49	138,69	154	100	65	80	24	403	7,30
21 XH 200	16200021	2F	St	21	148,56	145,77	160	110	65	80	24	404	8,73
22 XH 200	16200022	2F	St	22	155,64	152,84	168	110	65	80	24	405	9,55
24 XH 200	16200024	2F	St	24	169,79	166,99	183	120	65	80	24	406	11,47
25 XH 200	16200025	2F	St	25	176,86	174,07	188	120	65	80	24	407	12,46
26 XH 200	16200026	2F	St	26	183,93	181,14	198	120	65	80	24	409	13,47
27 XH 200	16200027	2F	St	27	191,01	188,22	200	120	65	80	24	410	14,42
28 XH 200	16200028	2F	St	28	198,09	195,29	211	120	65	80	24	411	15,44
30 XH 200	16200030	2F	St	30	212,23	209,44	226	120	65	80	24	412	17,69
32 XH 200	16200032	2F	St	32	226,38	223,59	240	120	65	80	24	414	19,95
34 XH 200	16200034	2F	St	34	240,53	237,74	256	120	65	80	24	415	22,75



PULEGGE DENTATE PER CINGHIE POSITIVE - ISO 5294 TIMING BELT PULLEYS - ISO 5294

XH 300

PASSO 7/8" (22,22 mm)

PER CINGHIE LARGHEZZA 3" (76,2 mm)

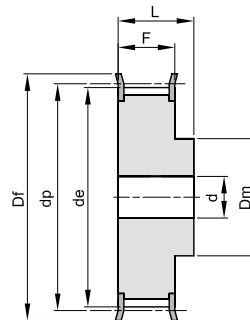

2F

Materiale: Acciaio (St)

descrizione	codice	tipo	materiale	denti	dp	de	Df	Dm	F	L	d	n° flangia	Kg.
18 XH 300	16300018	2F	St	18	127,34	124,55	138	100	92	110	28	401	8,90
19 XH 300	16300019	2F	St	19	134,41	131,62	146	100	92	110	28	402	9,20
20 XH 300	16300020	2F	St	20	141,49	138,69	154	100	92	110	28	403	10,61
21 XH 300	16300021	2F	St	21	148,56	145,77	160	110	92	110	28	404	11,87
22 XH 300	16300022	2F	St	22	155,64	152,84	168	110	92	110	28	405	13,08
24 XH 300	16300024	2F	St	24	169,79	166,99	183	120	92	110	28	406	15,77
25 XH 300	16300025	2F	St	25	176,86	174,07	188	120	92	110	28	407	17,13
26 XH 300	16300026	2F	St	26	183,93	181,14	198	120	92	110	28	409	18,55
27 XH 300	16300027	2F	St	27	191,01	188,22	200	120	92	110	28	410	19,90
28 XH 300	16300028	2F	St	28	198,09	195,29	211	150	92	110	28	411	22,27
30 XH 300	16300030	2F	St	30	212,23	209,44	226	150	92	110	28	412	25,39
32 XH 300	16300032	2F	St	32	226,38	223,59	240	150	92	110	28	414	28,73
34 XH 300	16300034	2F	St	34	240,53	237,74	256	150	92	110	28	415	34,20



PULEGGE DENTATE PER CINGHIE POSITIVE - ISO 5294

TIMING BELT PULLEYS - ISO 5294

XH 400

PASSO 7/8" (22,22 mm)

PER CINGHIE LARGHEZZA 4" (101,6 mm)

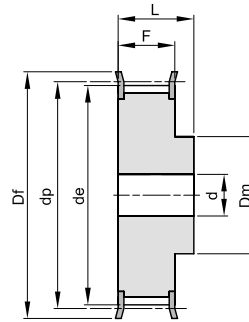

2F

Materiale: Acciaio (St)

descrizione	codice	tipo	materiale	denti	dp	de	Df	Dm	F	L	d	n° flangia	Kg.
18 XH 400	16400018	2F	St	18	127,34	124,55	138	100	119	132	32	401	9,60
19 XH 400	16400019	2F	St	19	134,41	131,62	146	100	119	132	32	402	10,80
20 XH 400	16400020	2F	St	20	141,49	138,69	154	100	119	132	32	403	12,87
21 XH 400	16400021	2F	St	21	148,56	145,77	160	110	119	132	32	404	14,42
22 XH 400	16400022	2F	St	22	155,64	152,84	168	110	119	132	32	405	15,44
24 XH 400	16400024	2F	St	24	169,79	166,99	183	120	119	132	32	406	19,22
25 XH 400	16400025	2F	St	25	176,86	174,07	188	120	119	132	32	407	21,05
26 XH 400	16400026	2F	St	26	183,93	181,14	198	120	119	132	32	409	22,80
27 XH 400	16400027	2F	St	27	191,01	188,22	200	120	119	132	32	410	24,66
28 XH 400	16400028	2F	St	28	198,09	195,29	211	150	119	132	32	411	27,23
30 XH 400	16400030	2F	St	30	212,23	209,44	226	150	119	132	32	412	31,30
32 XH 400	16400032	2F	St	32	226,38	223,59	240	150	119	132	32	414	35,20
34 XH 400	16400034	2F	St	34	240,53	237,74	256	150	119	132	32	415	40,00



PULEGGE DENTATE A BUSSOLA CONICA PER CINGHIE POSITIVE - ISO 5294

TIMING BELT PULLEYS FOR TAPER BUSHES - ISO 5294

L 050

PASSO 3/8" (9,525 mm)

PER CINGHIE LARGHEZZA 1/2" (12,7 mm)

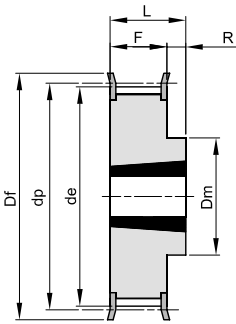

10F

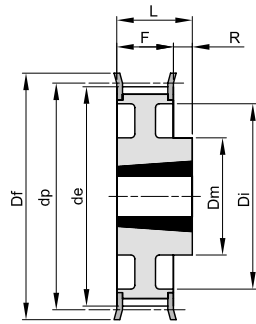

11F

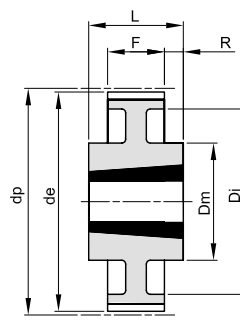

13

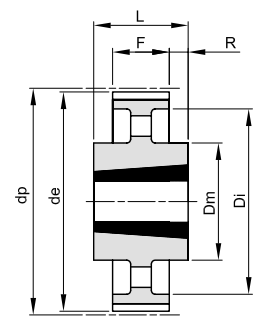

14

Materiale: Acciaio (St)
Materiale: Ghisa (GG)

descrizione	codice	tipo	materiale	denti	bussola	foro max	dp	de	Df	Dm	Di	F	L	R	n° flangia	Kg.
TL 18 L 050	21050018	10F	St	18	1108	28	54,57	53,81	60	45		19,0	22,0	3	308	0,20
TL 19 L 050	21050019	10F	St	19	1108	28	57,61	56,84	63	45		19,0	22,0	3	309	0,23
TL 20 L 050	21050020	10F	St	20	1108	28	60,64	59,88	66	48		19,0	22,0	3	310	0,27
TL 21 L 050	21050021	10F	St	21	1108	28	63,67	62,91	71	48		19,0	22,0	3	311	0,30
TL 22 L 050	21050022	10F	St	22	1108	28	66,70	65,94	75	51		19,0	22,0	3	312	0,34
TL 23 L 050	21050023	10F	St	23	1108	28	69,73	68,97	79	54		19,0	22,0	3	313	0,40
TL 24 L 050	21050024	10F	St	24	1108	28	72,77	72,00	79	54		19,0	22,0	3	313	0,45
TL 25 L 050	21050025	10F	St	25	1108	28	75,80	75,04	83	56		19,0	22,0	3	314	0,50
TL 26 L 050	21050026	10F	St	26	1108	28	78,83	78,07	87	60		19,0	22,0	3	315	0,55
TL 27 L 050	21050027	10F	St	27	1108	28	81,86	81,10	87	62		19,0	22,0	3	315	0,60
TL 28 L 050	21050028	10F	St	28	1108	28	84,89	84,13	91	65		19,0	22,0	3	316	0,65
TL 30 L 050	21050030	10F	St	30	1108	28	90,96	90,20	97	70		19,0	22,0	3	318	0,80
TL 32 L 050	21050032	10F	St	32	1108	28	97,02	96,26	103	74		19,0	22,0	3	320	0,98
TL 36 L 050	21050036	10F	St	36	1108	28	109,15	108,39	115	85		19,0	22,0	3	323	1,20
TL 40 L 050	21050040	10F	St	40	1610	42	121,28	120,51	127	97		19,0	25,0	6	327	1,40
TL 48 L 050	21050048	11F	St	48	1610	42	145,53	144,77	152	88	120	19,0	25,0	6	334	2,30
TL 60 L 050	21050060	13	St	60	1610	42	181,91	181,15		92	166	19,0	25,0	3		2,20
TL 72 L 050	21050072	14	GG	72	1610	42	218,30	217,53		92	202	19,0	25,0	3		2,10
TL 84 L 050	21050084	14	GG	84	1610	42	254,68	253,90		92	236	19,0	25,0	3		2,46
TL 96 L 050	21050096	14	GG	96	2012	50	291,06	290,30		106	270	19,0	32,0	6,5		3,36
TL120 L 050	21050120	14	GG	120	2012	50	363,83	363,07		106	343	19,0	32,0	6,5		4,44



PULEGGE DENTATE A BUSSOLA CONICA PER CINGHIE POSITIVE - ISO 5294

TIMING BELT PULLEYS FOR TAPER BUSHES - ISO 5294

L 075

PASSO 3/8" (9,525 mm)

PER CINGHIE LARGHEZZA 3/4" (19,05 mm)

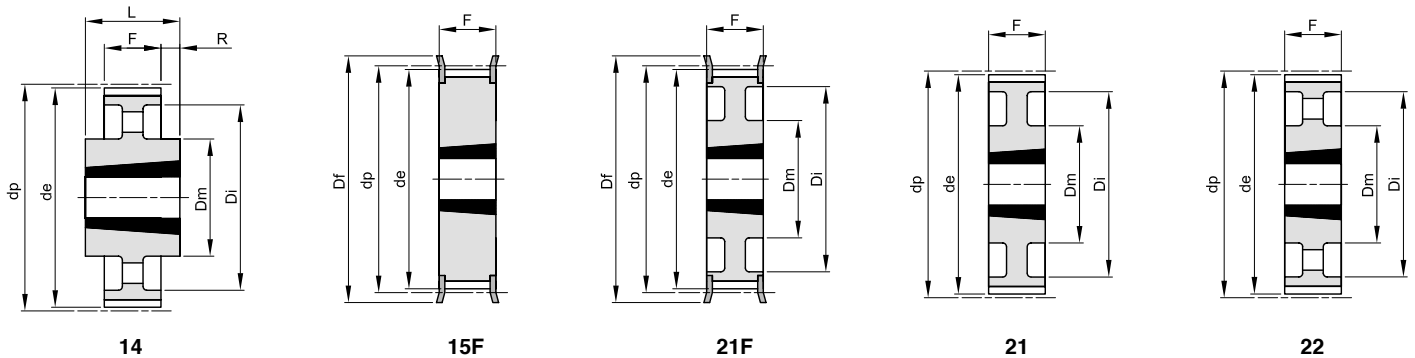

Materiale: Acciaio (St)
Materiale: Ghisa (GG)

descrizione	codice	tipo	materiale	denti	bussola	foro max	dp	de	Df	Dm	Di	F	L	R	n° flangia	Kg.
TL 18 L 075	21075018	15F	St	18	1108	28	54,57	53,81	60			25,0	25,0		308	0,25
TL 19 L 075	21075019	15F	St	19	1108	28	57,61	56,84	63			25,0	25,0		309	0,32
TL 20 L 075	21075020	15F	St	20	1108	28	60,64	59,88	66			25,0	25,0		310	0,35
TL 21 L 075	21075021	15F	St	21	1108	28	63,67	62,91	71			25,0	25,0		311	0,40
TL 22 L 075	21075022	15F	St	22	1108	28	66,70	65,94	75			25,0	25,0		312	0,44
TL 23 L 075	21075023	15F	St	23	1108	28	69,73	68,97	79			25,0	25,0		313	0,48
TL 24 L 075	21075024	15F	St	24	1108	28	72,77	72,00	79			25,0	25,0		313	0,55
TL 25 L 075	21075025	15F	St	25	1108	28	75,80	75,04	83			25,0	25,0		314	0,63
TL 26 L 075	21075026	15F	St	26	1108	28	78,83	78,07	87			25,0	25,0		315	0,66
TL 27 L 075	21075027	15F	St	27	1108	28	81,86	81,10	87			25,0	25,0		315	0,70
TL 28 L 075	21075028	15F	St	28	1108	28	84,89	84,13	91			25,0	25,0		316	0,72
TL 30 L 075	21075030	15F	St	30	1108	28	90,96	90,20	97			25,0	25,0		318	0,93
TL 32 L 075	21075032	15F	St	32	1108	28	97,02	96,26	103			25,0	25,0		320	1,10
TL 36 L 075	21075036	15F	St	36	1610	42	109,15	108,39	115			25,0	25,0		323	1,20
TL 40 L 075	21075040	15F	St	40	1610	42	121,28	120,51	127			25,0	25,0		327	1,70
TL 48 L 075	21075048	21F	St	48	1610	42	145,53	144,77	152	92	120	25,0	25,0		334	2,60
TL 60 L 075	21075060	21	St	60	1610	42	181,91	181,15		92	166	25,0	25,0			3,00
TL 72 L 075	21075072	22	GG	72	1610	42	218,30	217,53		92	202	25,0	25,0			2,33
TL 84 L 075	21075084	14	GG	84	2012	50	254,68	253,90		106	236	25,0	32,0	3,5		3,55
TL 96 L 075	21075096	14	GG	96	2012	50	291,06	290,30		106	270	25,0	32,0	3,5		3,95
TL120 L 075	21075120	14	GG	120	2012	50	363,83	363,07		106	343	25,0	32,0	3,5		5,61



PULEGGE DENTATE A BUSSOLA CONICA PER CINGHIE POSITIVE - ISO 5294

TIMING BELT PULLEYS FOR TAPER BUSHES - ISO 5294

L 100

PASSO 3/8" (9,525 mm)

PER CINGHIE LARGHEZZA 1" (25,4 mm)

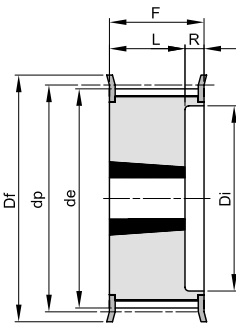

16F

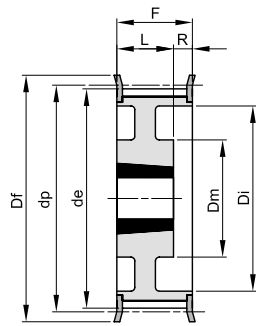

17F

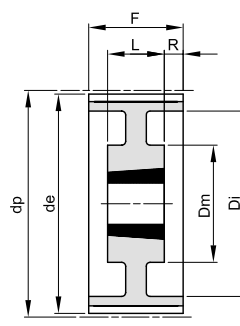

19

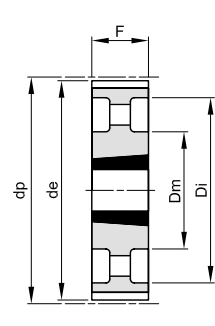

22

Materiale: Acciaio (St)
Materiale: Ghisa (GG)

descrizione	codice	tipo	materiale	denti	bussola	foro max	dp	de	Df	Dm	Di	F	L	R	n° flangia	Kg.
TL 18 L 100	21100018	16F	St	18	1108	28	54,57	53,81	60		38	31,0	22,0	9,0	308	0,20
TL 19 L 100	21100019	16F	St	19	1108	28	57,61	56,84	63		38	31,0	22,0	9,0	309	0,32
TL 20 L 100	21100020	16F	St	20	1108	28	60,64	59,88	66		45	31,0	22,0	9,0	310	0,41
TL 21 L 100	21100021	16F	St	21	1108	28	63,67	62,91	71		45	31,0	22,0	9,0	311	0,45
TL 22 L 100	21100022	16F	St	22	1108	28	66,70	65,94	75		48	31,0	22,0	9,0	312	0,47
TL 23 L 100	21100023	16F	St	23	1108	28	69,73	68,97	79		52	32,0	22,0	10,0	313	0,50
TL 24 L 100	21100024	16F	St	24	1108	28	72,77	72,00	79		52	32,0	22,0	10,0	313	0,64
TL 25 L 100	21100025	16F	St	25	1108	28	75,80	75,04	83		54	32,0	22,0	10,0	314	0,68
TL 26 L 100	21100026	16F	St	26	1108	28	78,83	78,07	87		60	32,0	22,0	10,0	315	0,70
TL 27 L 100	21100027	16F	St	27	1108	28	81,86	81,10	87		60	32,0	22,0	10,0	315	0,83
TL 28 L 100	21100028	16F	St	28	1108	28	84,89	84,13	91		65	32,0	22,0	10,0	316	0,85
TL 30 L 100	21100030	16F	St	30	1210	32	90,96	90,20	97		71	32,0	25,0	7,0	318	0,90
TL 32 L 100	21100032	16F	St	32	1210	32	97,02	96,26	103		75	32,0	25,0	7,0	320	1,05
TL 36 L 100	21100036	16F	St	36	1610	42	109,15	108,39	115		86	32,0	25,0	7,0	323	1,40
TL 40 L 100	21100040	16F	St	40	1610	42	121,28	120,51	127		96	32,0	25,0	7,0	327	1,65
TL 48 L 100	21100048	17F	St	48	1610	42	145,53	144,77	152	92	120	32,0	25,0	7,0	334	2,80
TL 60 L 100	21100060	19	St	60	1610	42	181,91	181,15		92	166	32,0	25,0	3,5		2,70
TL 72 L 100	21100072	22	GG	72	2012	50	218,30	217,53		106	202	32,0	32,0			2,96
TL 84 L 100	21100084	22	GG	84	2012	50	254,68	253,90		106	236	32,0	32,0			3,87
TL 96 L 100	21100096	22	GG	96	2012	50	291,06	290,30		106	270	32,0	32,0			4,64
TL120 L 100	21100120	22	GG	120	2012	50	363,83	363,07		106	343	32,0	32,0			6,37



PULEGGE DENTATE A BUSSOLA CONICA PER CINGHIE POSITIVE - ISO 5294

TIMING BELT PULLEYS FOR TAPER BUSHES - ISO 5294

H 100

PASSO 1/2" (12,7 mm)

PER CINGHIE LARGHEZZA 1" (25,4 mm)

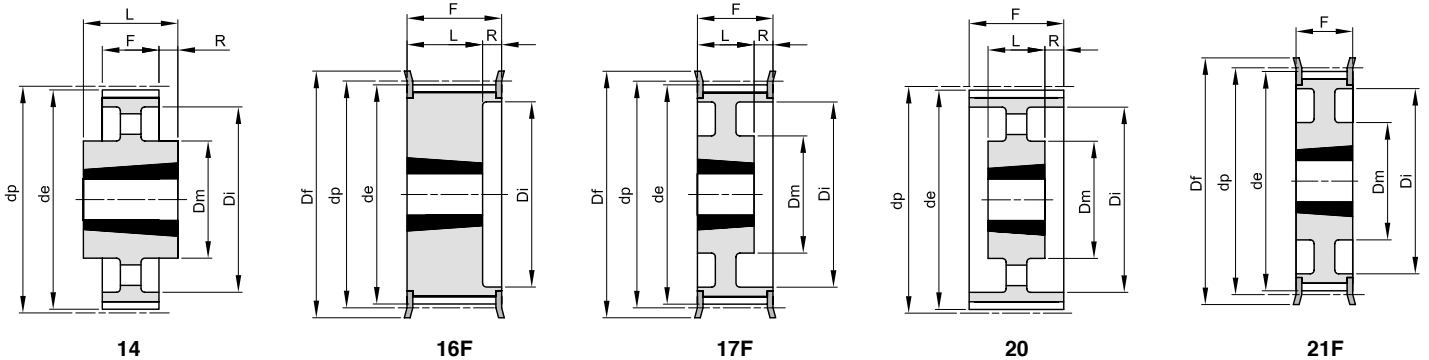

Materiale: Acciaio (St)
Materiale: Ghisa (GG)

descrizione	codice	tipo	materiale	denti	bussola	foro max	dp	de	Df	Dm	Di	F	L	R	n° flangia	Kg.
TL 16 H 100	22100016	16F	St	16	1108	28	64,68	63,31	71	45	31,0	22,0	9,0	311	0,42	
TL 18 H 100	22100018	16F	St	18	1210	32	72,77	71,39	79	52	31,0	25,0	6,0	313	0,49	
TL 19 H 100	22100019	16F	St	19	1210	32	76,81	75,44	83	56	31,0	25,0	6,0	314	0,62	
TL 20 H 100	22100020	16F	St	20	1210	32	80,85	79,48	87	60	31,0	25,0	6,0	315	0,73	
TL 21 H 100	22100021	16F	St	21	1210	32	84,89	83,52	91	64	32,0	25,0	7,0	316	0,80	
TL 22 H 100	22100022	16F	St	22	1210	32	88,94	87,56	93	67	32,0	25,0	7,0	317	0,94	
TL 23 H 100	22100023	16F	St	23	1610	42	92,98	91,61	97	70	32,0	25,0	7,0	318	0,97	
TL 24 H 100	22100024	16F	St	24	1610	42	97,02	95,65	103	73,5	32,0	25,0	7,0	320	1,05	
TL 25 H 100	22100025	16F	St	25	1610	42	101,06	99,69	106	77	32,0	25,0	7,0	321	1,10	
TL 26 H 100	22100026	16F	St	26	1610	42	105,11	103,73	111	82	32,0	25,0	7,0	322	1,20	
TL 27 H 100	22100027	16F	St	27	1610	42	109,15	107,78	115	85	32,0	25,0	7,0	323	1,35	
TL 28 H 100	22100028	16F	St	28	1610	42	113,19	111,82	119	90,5	32,0	25,0	7,0	325	1,50	
TL 30 H 100	22100030	16F	St	30	1610	42	121,28	119,90	127	98	32,0	25,0	7,0	327	1,78	
TL 32 H 100	22100032	17F	St	32	1610	42	129,36	127,99	135	90	106	32,0	25,0	7,0	328	2,05
TL 36 H 100	22100036	17F	St	36	1610	42	145,53	144,16	152	92	121	32,0	25,0	7,0	334	2,80
TL 40 H 100	22100040	17F	St	40	1610	42	161,70	160,33	168	92	138	32,0	25,0	7,0	338	3,65
TL 44 H 100	22100044	21F	St	44	2012	50	177,87	176,50	184	106	152	32,0	32,0		339	3,86
TL 48 H 100	22100048	21F	St	48	2012	50	194,04	192,67	200	106	169	32,0	32,0		342	4,20
TL 60 H 100	22100060	20	GG	60	2012	50	242,55	241,18		106	223	34,0	32,0	1,0		3,76
TL 72 H 100	22100072	20	GG	72	2012	50	291,06	289,69		106	270	34,0	32,0	1,0		4,88
TL 84 H 100	22100084	20	GG	84	2012	50	339,57	338,20		106	318	34,0	32,0	1,0		6,12
TL 96 H 100	22100096	14	GG	96	2517	60	388,08	386,71		119	366	34,0	45,0	5,5		7,95
TL120 H 100	22100120	14	GG	120	2517	60	485,10	483,73		119	462	34,0	45,0	5,5		10,05



PULEGGE DENTATE A BUSSOLA CONICA PER CINGHIE POSITIVE - ISO 5294

TIMING BELT PULLEYS FOR TAPER BUSHES - ISO 5294

H 150

PASSO 1/2" (12,7 mm)

PER CINGHIE LARGHEZZA 1 1/2 (38,1 mm)

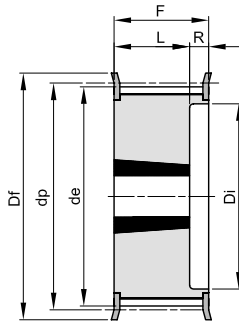

16F

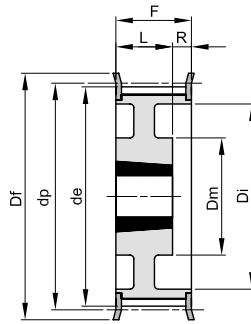

17F

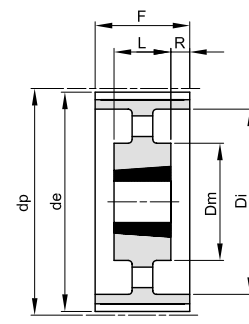

20

Materiale: Acciaio (St)
Materiale: Ghisa (GG)

descrizione	codice	tipo	materiale	denti	bussola	foro max	dp	de	Df	Dm	Di	F	L	R	n° flangia	Kg.
TL 18 H 150	22150018	16F	St	18	1210	32	72,77	71,39	79		52	45,0	25,0	20,0	313	0,60
TL 19 H 150	22150019	16F	St	19	1210	32	76,81	75,44	83		56	45,0	25,0	20,0	314	0,72
TL 20 H 150	22150020	16F	St	20	1210	32	80,85	79,48	87		60	45,0	25,0	20,0	315	0,83
TL 21 H 150	22150021	16F	St	21	1210	32	84,89	83,52	91		64	45,0	25,0	20,0	316	1,00
TL 22 H 150	22150022	16F	St	22	1210	32	88,94	87,56	93		67	45,0	25,0	20,0	317	1,25
TL 23 H 150	22150023	16F	St	23	1610	42	92,98	91,61	97		70	45,0	25,0	20,0	318	1,05
TL 24 H 150	22150024	16F	St	24	1610	42	97,02	95,65	103		73,5	45,0	25,0	20,0	320	1,10
TL 25 H 150	22150025	16F	St	25	1610	42	101,06	99,69	106		77	45,0	25,0	20,0	321	1,30
TL 26 H 150	22150026	16F	St	26	1610	42	105,11	103,73	111		82	45,0	25,0	20,0	322	1,42
TL 27 H 150	22150027	16F	St	27	1610	42	109,15	107,78	115		85	45,0	25,0	20,0	323	1,65
TL 28 H 150	22150028	16F	St	28	1610	42	113,19	111,82	119		90,5	45,0	25,0	20,0	325	1,88
TL 30 H 150	22150030	16F	St	30	1610	42	121,28	119,90	127		98	45,0	25,0	20,0	327	2,05
TL 32 H 150	22150032	17F	St	32	1610	42	129,36	127,99	135	90	106	45,0	25,0	20,0	328	2,35
TL 36 H 150	22150036	17F	St	36	1610	42	145,53	144,16	152	92	121	45,0	25,0	20,0	334	3,20
TL 40 H 150	22150040	17F	St	40	1610	42	161,70	160,33	168	92	138	45,0	25,0	20,0	338	4,10
TL 44 H 150	22150044	17F	St	44	2012	50	177,87	176,50	184	106	152	45,0	32,0	13,0	339	4,50
TL 48 H 150	22150048	17F	St	48	2012	50	194,04	192,67	200	106	169	45,0	32,0	13,0	342	4,80
TL 60 H 150	22150060	20	GG	60	2012	50	242,55	241,18		106	223	46,0	32,0	7,0		4,51
TL 72 H 150	22150072	20	GG	72	2012	50	291,06	289,69		106	270	46,0	32,0	7,0		6,16
TL 84 H 150	22150084	20	GG	84	2012	50	339,57	338,20		106	320	46,0	32,0	7,0		7,40
TL 96 H 150	22150096	20	GG	96	2517	60	388,08	386,71		119	366	46,0	45,0	0,5		9,87
TL120 H 150	22150120	20	GG	120	2517	60	485,10	483,73		119	462	46,0	45,0	0,5		13,50



PULEGGE DENTATE A BUSSOLA CONICA PER CINGHIE POSITIVE - ISO 5294

TIMING BELT PULLEYS FOR TAPER BUSHES - ISO 5294

H 200

PASSO 1/2" (12,7 mm)

PER CINGHIE LARGHEZZA 2" (50,8 mm)

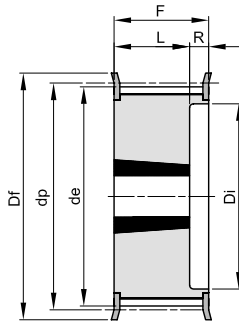

16F

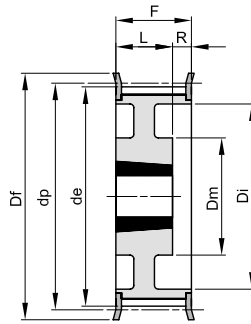

17F

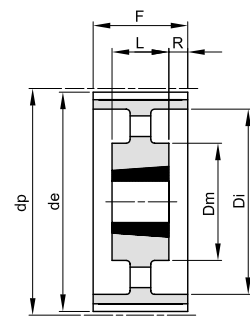

20

Materiale: Acciaio (St)
Materiale: Ghisa (GG)

descrizione	codice	tipo	materiale	denti	bussola	foro max	dp	de	Df	Dm	Di	F	L	R	n° flangia	Kg.
TL 18 H 200	22200018	16F	St	18	1210	32	72,77	71,39	79		52	58,0	25,0	33,0	313	0,84
TL 19 H 200	22200019	16F	St	19	1210	32	76,81	75,44	83		56	58,0	25,0	33,0	314	0,96
TL 20 H 200	22200020	16F	St	20	1610	42	80,85	79,48	87		60	58,0	25,0	33,0	315	0,93
TL 21 H 200	22200021	16F	St	21	1610	42	84,89	83,52	91		64	58,0	25,0	33,0	316	1,07
TL 22 H 200	22200022	16F	St	22	1610	42	88,94	87,56	93		67	58,0	25,0	33,0	317	1,25
TL 23 H 200	22200023	16F	St	23	1610	42	92,98	91,61	97		70	58,0	25,0	33,0	318	1,40
TL 24 H 200	22200024	16F	St	24	1610	42	97,02	95,65	103		73,5	58,0	25,0	33,0	320	1,55
TL 25 H 200	22200025	16F	St	25	1610	42	101,06	99,69	106		77	58,0	25,0	33,0	321	1,71
TL 26 H 200	22200026	16F	St	26	1610	42	105,11	103,73	111		82	58,0	25,0	33,0	322	1,84
TL 27 H 200	22200027	16F	St	27	1610	42	109,15	107,78	115		85	58,0	25,0	33,0	323	2,06
TL 28 H 200	22200028	16F	St	28	1610	42	113,19	111,82	119		90,5	58,0	25,0	33,0	325	2,17
TL 30 H 200	22200030	16F	St	30	1610	42	121,28	119,90	127		98	58,0	25,0	33,0	327	2,60
TL 32 H 200	22200032	16F	St	32	2012	50	129,36	127,99	135		106	58,0	32,0	26,0	328	2,95
TL 36 H 200	22200036	17F	St	36	2012	50	145,53	144,16	152	102	121	58,0	32,0	26,0	334	3,62
TL 40 H 200	22200040	17F	St	40	2012	50	161,70	160,33	168	106	138	58,0	32,0	26,0	338	4,33
TL 44 H 200	22200044	17F	St	44	2012	50	177,87	176,50	184	106	152	58,0	32,0	26,0	339	5,33
TL 48 H 200	22200048	17F	St	48	2517	60	194,04	192,67	200	119	169	58,0	45,0	13,0	342	6,47
TL 60 H 200	22200060	20	GG	60	2517	60	242,55	241,18		119	223	60,0	45,0	7,5		5,86
TL 72 H 200	22200072	20	GG	72	2517	60	291,06	289,69		119	270	60,0	45,0	7,5		7,42
TL 84 H 200	22200084	20	GG	84	2517	60	339,57	338,20		119	320	60,0	45,0	7,5		8,73
TL 96 H 200	22200096	20	GG	96	2517	60	388,08	386,71		119	366	60,0	45,0	7,5		10,83
TL120 H 200	22200120	20	GG	120	2517	60	485,10	483,73		119	462	60,0	45,0	7,5		14,95



PULEGGE DENTATE A BUSSOLA CONICA PER CINGHIE POSITIVE - ISO 5294

TIMING BELT PULLEYS FOR TAPER BUSHES - ISO 5294

H 300

PASSO 1/2" (12,7 mm)

PER CINGHIE LARGHEZZA 3" (76,2 mm)

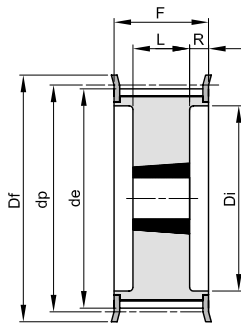

18F

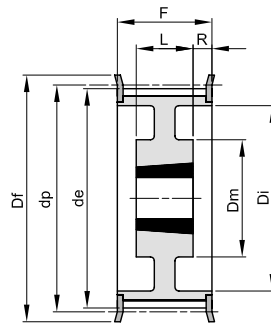

19F

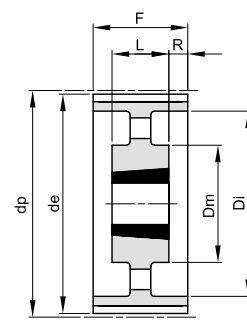

20

Materiale: Acciaio (St)
Materiale: Ghisa (GG)

descrizione	codice	tipo	materiale	denti	bussola	foro max	dp	de	Df	Dm	Di	F	L	R	n° flangia	Kg.
TL 20 H 300	22300020	18F	St	20	1615	42	80,85	79,48	87		64,5	84,0	38,0	23,0	315	1,22
TL 21 H 300	22300021	18F	St	21	1615	42	84,89	83,52	91		65	84,0	38,0	23,0	316	1,52
TL 22 H 300	22300022	18F	St	22	1615	42	88,94	87,56	93		67	84,0	38,0	23,0	317	1,80
TL 23 H 300	22300023	18F	St	23	1615	42	92,98	91,61	97		70	84,0	38,0	23,0	318	2,04
TL 24 H 300	22300024	18F	St	24	1615	42	97,02	95,65	103		73,5	84,0	38,0	23,0	320	2,29
TL 25 H 300	22300025	18F	St	25	1615	42	101,06	99,69	106		77	84,0	38,0	23,0	321	2,54
TL 26 H 300	22300026	18F	St	26	1615	42	105,11	103,73	111		82	84,0	38,0	23,0	322	2,73
TL 27 H 300	22300027	18F	St	27	2012	50	109,15	107,78	115		85	84,0	32,0	26,0	323	2,54
TL 28 H 300	22300028	18F	St	28	2012	50	113,19	111,82	119		90,5	84,0	32,0	26,0	325	2,68
TL 30 H 300	22300030	18F	St	30	2012	50	121,28	119,90	127		98	84,0	32,0	26,0	327	3,21
TL 32 H 300	22300032	18F	St	32	2517	60	129,36	127,99	135		106	84,0	45,0	19,5	328	3,58
TL 36 H 300	22300036	18F	St	36	2517	60	145,53	144,16	152		121	84,0	45,0	19,5	334	4,99
TL 40 H 300	22300040	18F	St	40	2517	60	161,70	160,33	168		138	84,0	45,0	19,5	338	6,50
TL 44 H 300	22300044	19F	St	44	2517	60	177,87	176,50	184	119	152	86,0	45,0	20,5	339	7,55
TL 48 H 300	22300048	19F	St	48	2517	60	194,04	192,67	200	119	169	86,0	45,0	20,5	342	8,66
TL 60 H 300	22300060	20	GG	60	2517	60	242,55	241,18		119	223	86,0	45,0	20,5		7,42
TL 72 H 300	22300072	20	GG	72	2517	60	291,06	289,69		119	270	86,0	45,0	20,5		9,33
TL 84 H 300	22300084	20	GG	84	2517	60	339,57	338,20		119	320	86,0	45,0	20,5		11,19
TL 96 H 300	22300096	20	GG	96	3030	75	388,08	386,71		150	362	86,0	76,0	5,0		17,96
TL120 H 300	22300120	20	GG	120	3030	75	485,10	483,73		150	460	86,0	76,0	5,0		22,23



PULEGGE DENTATE PER CINGHIE HTD®

HTD® TIMING BELT PULLEYS

3M

PASSO 3 mm

PER CINGHIE LARGHEZZA 9 mm

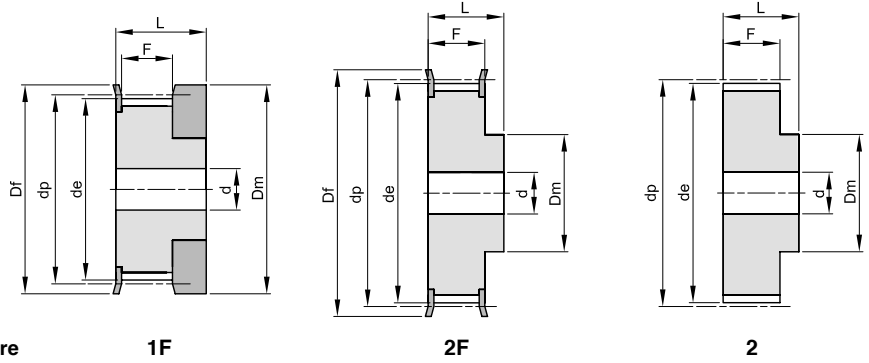

Materiale: Alluminio UNI 9006 - T6 (Al)
adatto per l'ossidazione dura a spessore

descrizione	codice	tipo	materiale	denti	dp	de	Df	Dm	Di	F	L	d	n° flangia	Kg.
10 3M 09	40009010	1F	Al	10	9,55	8,79	13,0	12,0		10,2	17,5		100	0,01
12 3M 09	40009012	1F	Al	12	11,46	10,70	15,0	15,0		10,2	17,5		101	0,01
14 3M 09	40009014	1F	Al	14	13,37	12,61	16,0	16,0		10,2	17,5		102	0,01
15 3M 09	40009015	1F	Al	15	14,32	13,56	18,0	17,5		10,2	17,5		104	0,01
16 3M 09	40009016	2F	Al	16	15,28	14,52	18,0	10,0		12,8	20,6		104	0,01
18 3M 09	40009018	2F	Al	18	17,19	16,43	19,5	11,0		12,8	20,6	6	105	0,01
20 3M 09	40009020	2F	Al	20	19,10	18,34	23,0	13,0		12,8	20,6	6	107	0,01
21 3M 09	40009021	2F	Al	21	20,05	19,29	25,0	14,0		12,8	20,6	6	108	0,01
22 3M 09	40009022	2F	Al	22	21,01	20,25	25,0	14,0		12,8	20,6	6	108	0,01
24 3M 09	40009024	2F	Al	24	22,92	22,16	25,0	14,0		12,8	20,6	6	108	0,02
26 3M 09	40009026	2F	Al	26	24,83	24,07	28,0	16,0		12,8	20,6	6	109	0,02
28 3M 09	40009028	2F	Al	28	26,74	25,98	32,0	18,0		12,8	20,6	6	110	0,02
30 3M 09	40009030	2F	Al	30	28,65	27,89	32,0	20,0		12,8	20,6	6	110	0,03
32 3M 09	40009032	2F	Al	32	30,56	29,80	36,0	22,0		12,8	20,6	6	111	0,03
36 3M 09	40009036	2F	Al	36	34,38	33,62	38,0	26,0		13,4	22,2	6	112	0,05
40 3M 09	40009040	2F	Al	40	38,20	37,44	42,0	28,0		13,4	22,2	6	113	0,06
44 3M 09	40009044	2F	Al	44	42,02	41,26	48,0	33,0		13,4	22,2	6	114	0,07
48 3M 09	40009048	2	Al	48	45,84	45,08		33,0		13,4	22,2	8		0,11
60 3M 09	40009060	2	Al	60	57,30	56,54		33,0		13,4	22,2	8		0,11
72 3M 09	40009072	2	Al	72	68,76	68,00		33,0		13,4	22,2	8		0,15



PULEGGE DENTATE PER CINGHIE HTD®

HTD® TIMING BELT PULLEYS

3M

PASSO 3 mm

PER CINGHIE LARGHEZZA 15 mm

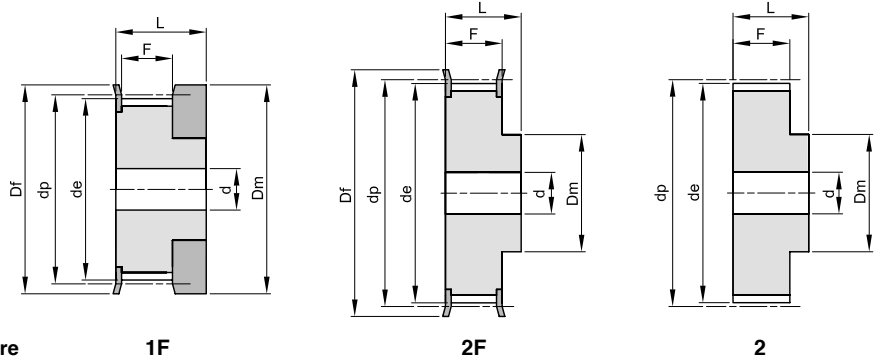

Materiale: Alluminio UNI 9006 - T6 (Al)
adatto per l'ossidazione dura a spessore

descrizione	codice	tipo	materiale	denti	dp	de	Df	Dm	Di	F	L	d	n° flangia	Kg.
10 3M 15	40015010	1F	Al	10	9,55	8,79	13,0	12,0		17,0	26,0		100	0,01
12 3M 15	40015012	1F	Al	12	11,46	10,70	15,0	15,0		17,0	26,0		101	0,01
14 3M 15	40015014	1F	Al	14	13,37	12,61	16,0	16,0		17,0	26,0		102	0,01
15 3M 15	40015015	1F	Al	15	14,32	13,56	18,0	17,5		17,0	26,0		104	0,01
16 3M 15	40015016	2F	Al	16	15,28	14,52	18,0	10,0		19,5	26,0		104	0,01
18 3M 15	40015018	2F	Al	18	17,19	16,43	19,5	11,0		19,5	26,0	6	105	0,01
20 3M 15	40015020	2F	Al	20	19,10	18,34	23,0	13,0		19,5	26,0	6	107	0,01
21 3M 15	40015021	2F	Al	21	20,05	19,29	25,0	14,0		19,5	26,0	6	108	0,02
22 3M 15	40015022	2F	Al	22	21,01	20,25	25,0	14,0		19,5	26,0	6	108	0,02
24 3M 15	40015024	2F	Al	24	22,92	22,16	25,0	14,0		19,5	26,0	6	108	0,02
26 3M 15	40015026	2F	Al	26	24,83	24,07	28,0	16,0		19,5	26,0	6	109	0,03
28 3M 15	40015028	2F	Al	28	26,74	25,98	32,0	18,0		19,5	26,0	6	110	0,03
30 3M 15	40015030	2F	Al	30	28,65	27,89	32,0	20,0		19,5	26,0	6	110	0,04
32 3M 15	40015032	2F	Al	32	30,56	29,80	36,0	22,0		19,5	26,0	6	111	0,04
36 3M 15	40015036	2F	Al	36	34,38	33,62	38,0	26,0		20,0	30,0	6	112	0,06
40 3M 15	40015040	2F	Al	40	38,20	37,44	42,0	28,0		20,0	30,0	6	113	0,08
44 3M 15	40015044	2F	Al	44	42,02	41,26	48,0	33,0		20,0	30,0	6	114	0,10
48 3M 15	40015048	2	Al	48	45,84	45,08		33,0		20,0	30,0	8		0,10
60 3M 15	40015060	2	Al	60	57,30	56,54		33,0		20,0	30,0	8		0,15
72 3M 15	40015072	2	Al	72	68,76	68,00		33,0		20,0	30,0	8		0,21



PULEGGE DENTATE PER CINGHIE HTD®

HTD® TIMING BELT PULLEYS

5M

PASSO 5 mm

PER CINGHIE LARGHEZZA 9 mm

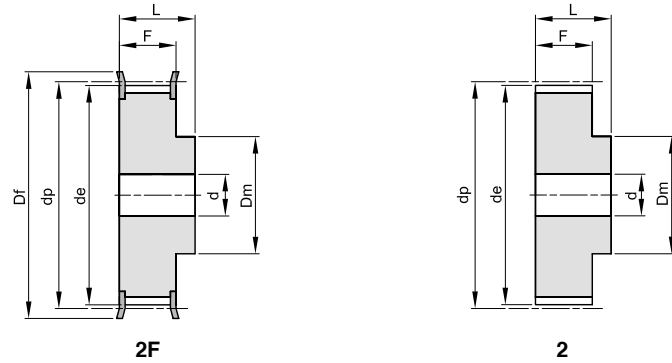

Materiale: Acciaio (St)
 Materiale: Alluminio UNI 9006 - T6 (Al)
 adatto per l'ossidazione dura a spessore

descrizione	codice	tipo	materiale	denti	dp	de	Df	Dm	Di	F	L	d	n° flangia	Kg.
12 5M 09	41009012	2F	St	12	19,10	17,96	23	12,5		14,5	20,0	6	202	0,03
14 5M 09	41009014	2F	St	14	22,28	21,14	25	13,5		14,5	20,0	6	203	0,04
15 5M 09	41009015	2F	St	15	23,87	22,73	28	16,0		14,5	20,0	6	204	0,05
16 5M 09	41009016	2F	St	16	25,46	24,32	28	16,5		14,5	20,0	6	204	0,05
18 5M 09	41009018	2F	St	18	28,65	27,51	32	20,0		14,5	20,0	6	205	0,07
20 5M 09	41009020	2F	St	20	31,83	30,69	36	23,0		14,5	22,5	6	206	0,10
21 5M 09	41009021	2F	St	21	33,42	32,28	38	24,0		14,5	22,5	6	207	0,12
22 5M 09	41009022	2F	St	22	35,01	33,87	38	25,5		14,5	22,5	6	207	0,13
24 5M 09	41009024	2F	St	24	38,20	37,06	42	27,0		14,5	22,5	6	208	0,15
26 5M 09	41009026	2F	St	26	41,38	40,24	44	30,0		14,5	22,5	6	209	0,18
28 5M 09	41009028	2F	St	28	44,56	43,42	48	30,5		14,5	22,5	6	210	0,21
30 5M 09	41009030	2F	St	30	47,75	46,60	51	35,0		14,5	22,5	6	211	0,25
32 5M 09	41009032	2F	St	32	50,93	49,79	54	38,0		14,5	22,5	8	212	0,28
36 5M 09	41009036	2F	St	36	57,30	56,16	60	38,0		14,5	22,5	8	214	0,33
40 5M 09	41009040	2F	St	40	63,66	62,52	71	38,0		14,5	22,5	8	217	0,42
44 5M 09	41009044	2	Al	44	70,03	68,89		38,0		14,5	25,5	8		0,17
48 5M 09	41009048	2	Al	48	76,39	75,25		45,0		14,5	25,5	8		0,18
60 5M 09	41009060	2	Al	60	95,49	94,35		45,0		14,5	25,5	8		0,23
72 5M 09	41009072	2	Al	72	114,59	113,45		45,0		14,5	25,5	8		0,42



PULEGGE DENTATE PER CINGHIE HTD®

HTD® TIMING BELT PULLEYS

5M

PASSO 5 mm

PER CINGHIE LARGHEZZA 15 mm

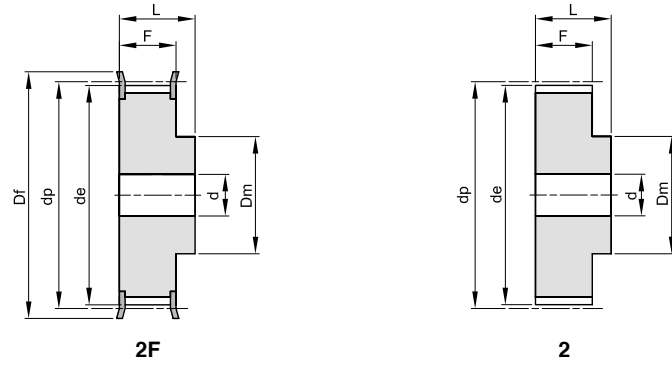

Materiale: Acciaio (St)
 Materiale: Alluminio UNI 9006 - T6 (Al)
 adatto per l'ossidazione dura a spessore

descrizione	codice	tipo	materiale	denti	dp	de	Df	Dm	Di	F	L	d	n° flangia	Kg.
12 5M 15	41015012	2F	St	12	19,10	17,96	23	12,5		20,5	26	6	202	0,03
14 5M 15	41015014	2F	St	14	22,28	21,14	25	13,5		20,5	26	6	203	0,04
15 5M 15	41015015	2F	St	15	23,87	22,73	28	16,0		20,5	26	6	204	0,05
16 5M 15	41015016	2F	St	16	25,46	24,32	28	16,5		20,5	26	6	204	0,06
18 5M 15	41015018	2F	St	18	28,65	27,51	32	20,0		20,5	26	6	205	0,09
20 5M 15	41015020	2F	St	20	31,83	30,69	36	23,0		20,5	26	6	206	0,12
21 5M 15	41015021	2F	St	21	33,42	32,28	38	24,0		20,5	26	6	207	0,14
22 5M 15	41015022	2F	St	22	35,01	33,87	38	25,5		20,5	26	6	207	0,15
24 5M 15	41015024	2F	St	24	38,20	37,06	42	27,0		20,5	28	6	208	0,19
26 5M 15	41015026	2F	St	26	41,38	40,24	44	30,0		20,5	28	6	209	0,23
28 5M 15	41015028	2F	St	28	44,56	43,42	48	30,5		20,5	28	6	210	0,26
30 5M 15	41015030	2F	St	30	47,75	46,60	51	35,0		20,5	28	6	211	0,32
32 5M 15	41015032	2F	St	32	50,93	49,79	54	38,0		20,5	28	8	212	0,35
36 5M 15	41015036	2F	St	36	57,30	56,16	60	38,0		20,5	28	8	214	0,43
40 5M 15	41015040	2F	St	40	63,66	62,52	71	38,0		20,5	28	8	217	0,52
44 5M 15	41015044	2	Al	44	70,03	68,89		38,0		20,5	30	8		0,23
48 5M 15	41015048	2	Al	48	76,39	75,25		38,0		20,5	30	8		0,29
60 5M 15	41015060	2	Al	60	95,49	94,35		50,0		20,5	30	8		0,42
72 5M 15	41015072	2	Al	72	114,59	113,45		50,0		20,5	30	8		0,59



PULEGGE DENTATE PER CINGHIE HTD®

HTD® TIMING BELT PULLEYS

5M

PASSO 5 mm

PER CINGHIE LARGHEZZA 25 mm

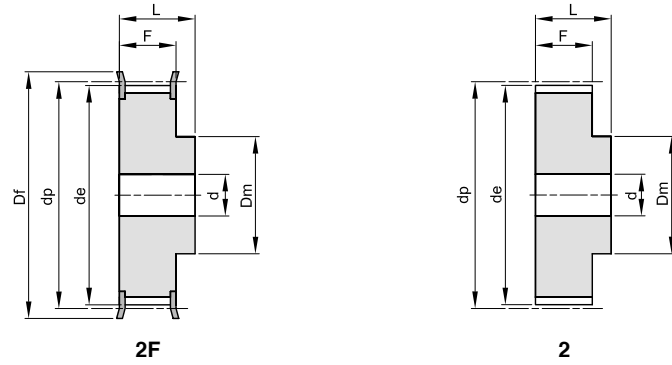

Materiale: Acciaio (St)
 Materiale: Alluminio UNI 9006 - T6 (Al)
 adatto per l'ossidazione dura a spessore

descrizione	codice	tipo	materiale	denti	dp	de	Df	Dm	Di	F	L	d	n° flangia	Kg.
12 5M 25	41025012	2F	St	12	19,10	17,96	23	12,5		30,5	36	6	202	0,05
14 5M 25	41025014	2F	St	14	22,28	21,14	25	13,5		30,5	36	6	203	0,08
15 5M 25	41025015	2F	St	15	23,87	22,73	28	16,0		30,5	36	6	204	0,09
16 5M 25	41025016	2F	St	16	25,46	24,32	28	16,5		30,5	36	6	204	0,11
18 5M 25	41025018	2F	St	18	28,65	27,51	32	20,0		30,5	36	6	205	0,13
20 5M 25	41025020	2F	St	20	31,83	30,69	36	23,0		30,5	36	6	206	0,17
21 5M 25	41025021	2F	St	21	33,42	32,28	38	24,0		30,5	38	6	207	0,20
22 5M 25	41025022	2F	St	22	35,01	33,87	38	25,5		30,5	38	6	207	0,22
24 5M 25	41025024	2F	St	24	38,20	37,06	42	27,0		30,5	38	6	208	0,26
26 5M 25	41025026	2F	St	26	41,38	40,24	44	30,0		30,5	38	6	209	0,32
28 5M 25	41025028	2F	St	28	44,56	43,42	48	30,5		30,5	38	6	210	0,37
30 5M 25	41025030	2F	St	30	47,75	46,60	51	35,0		30,5	38	6	211	0,42
32 5M 25	41025032	2F	St	32	50,93	49,79	54	38,0		30,5	38	8	212	0,48
36 5M 25	41025036	2F	St	36	57,30	56,16	60	38,0		30,5	38	8	214	0,59
40 5M 25	41025040	2F	St	40	63,66	62,52	71	38,0		30,5	38	8	217	0,75
44 5M 25	41025044	2	Al	44	70,03	68,89		38,0		30,5	40	8		0,32
48 5M 25	41025048	2	Al	48	76,39	75,25		38,0		30,5	40	8		0,28
60 5M 25	41025060	2	Al	60	95,49	94,35		50,0		30,5	40	8		0,44
72 5M 25	41025072	2	Al	72	114,59	113,45		50,0		30,5	40	8		0,85



PULEGGE DENTATE PER CINGHIE HTD®

HTD® TIMING BELT PULLEYS

8M

PASSO 8 mm

PER CINGHIE LARGHEZZA 20 mm

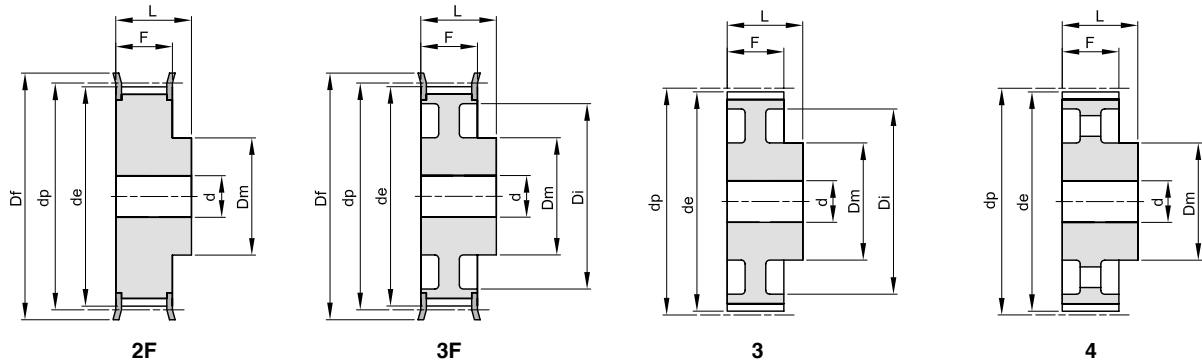

Materiale: Acciaio (St)
Materiale: Ghisa (GG)

descrizione	codice	tipo	materiale	denti	dp	de	Df	Dm	Di	F	L	d	n° flangia	Kg.
22 8M 20	42020022	2F	St	22	56,02	54,65	60	43		28	38	12	308	0,54
24 8M 20	42020024	2F	St	24	61,11	59,74	66	45		28	38	12	310	0,65
26 8M 20	42020026	2F	St	26	66,21	64,84	71	48		28	38	12	311	0,80
28 8M 20	42020028	2F	St	28	71,30	70,08	75	50		28	38	14	312	0,88
30 8M 20	42020030	2F	St	30	76,39	75,13	83	55		28	38	14	314	1,00
32 8M 20	42020032	2F	St	32	81,49	80,16	87	60		28	38	14	315	1,20
34 8M 20	42020034	2F	St	34	86,58	85,21	91	66		28	38	14	316	1,40
36 8M 20	42020036	2F	St	36	91,67	90,30	98	70		28	38	14	319	1,60
38 8M 20	42020038	2F	St	38	96,77	95,39	103	75		28	38	14	320	1,70
40 8M 20	42020040	2F	St	40	101,86	100,49	106	75		28	38	14	321	1,85
44 8M 20	42020044	2F	St	44	112,05	110,67	119	75		28	38	14	325	2,10
48 8M 20	42020048	2F	St	48	122,23	120,86	127	75		28	38	14	327	2,50
56 8M 20	42020056	3F	St	56	142,60	141,23	148	80	116	28	38	14	333	2,82
64 8M 20	42020064	3F	St	64	162,97	161,60	168	80	137	28	38	14	338	3,22
72 8M 20	42020072	3F	St	72	183,35	181,97	192	80	158	28	38	14	340	3,74
80 8M 20	42020080	3	GG	80	203,72	202,35		90	180	28	38	14		3,78
90 8M 20	42020090	3	GG	90	229,18	227,81		90	204	28	38	14		4,57
* 112 8M 20	42020112	4	GG	112	285,21	283,83		90	254	28	38	18		
* 144 8M 20	42020144	4	GG	144	366,69	365,32		90	336	28	38	20		
* 168 8M 20	42020168	4	GG	168	427,81	426,44		100	400	28	38	20		
* 192 8M 20	42020192	4	GG	192	488,92	487,55		100	460	28	38	20		

* Costruite a richiesta / Manufactured on request



PULEGGE DENTATE PER CINGHIE HTD®

HTD® TIMING BELT PULLEYS

8M

PASSO 8 mm

PER CINGHIE LARGHEZZA 30 mm

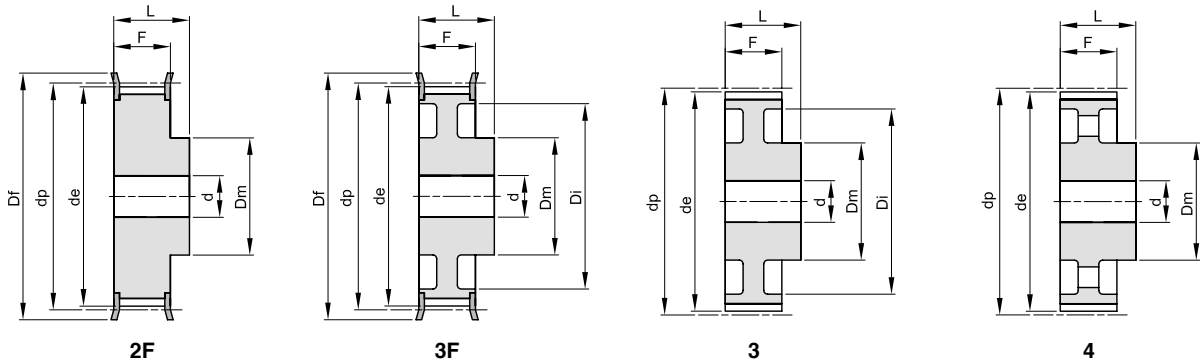

Materiale: Acciaio (St)
Materiale: Ghisa (GG)

descrizione	codice	tipo	materiale	denti	dp	de	Df	Dm	Di	F	L	d	n° flangia	Kg.
22 8M 30	42030022	2F	St	22	56,02	54,65	60	43		38	48	12	308	0,75
24 8M 30	42030024	2F	St	24	61,11	59,74	66	45		38	48	12	310	0,90
26 8M 30	42030026	2F	St	26	66,21	64,84	71	48		38	48	12	311	1,10
28 8M 30	42030028	2F	St	28	71,30	70,08	75	50		38	48	14	312	1,20
30 8M 30	42030030	2F	St	30	76,39	75,13	83	55		38	48	14	314	1,32
32 8M 30	42030032	2F	St	32	81,49	80,16	87	60		38	48	14	315	1,55
34 8M 30	42030034	2F	St	34	86,58	85,21	91	66		38	48	14	316	1,80
36 8M 30	42030036	2F	St	36	91,67	90,30	98	70		38	48	14	319	2,10
38 8M 30	42030038	2F	St	38	96,77	95,39	103	75		38	48	14	320	2,30
40 8M 30	42030040	2F	St	40	101,86	100,49	106	75		38	48	14	321	2,47
44 8M 30	42030044	2F	St	44	112,05	110,67	119	75		38	48	14	325	2,95
48 8M 30	42030048	2F	St	48	122,23	120,86	127	75		38	48	14	327	3,30
56 8M 30	42030056	3F	St	56	142,60	141,23	148	90	116	38	48	14	333	4,02
64 8M 30	42030064	3F	St	64	162,97	161,60	168	90	137	38	48	14	338	4,60
72 8M 30	42030072	3F	St	72	183,35	181,97	192	95	158	38	48	14	340	5,41
80 8M 30	42030080	3	GG	80	203,72	202,35		100	180	38	48	14		5,23
90 8M 30	42030090	3	GG	90	229,18	227,81		100	204	38	48	14		6,42
112 8M 30	42030112	4	GG	112	285,21	283,83		100	254	38	48	18		8,12
144 8M 30	42030144	4	GG	144	366,69	365,32		100	336	38	48	20		10,36
168 8M 30	42030168	4	GG	168	427,81	426,44		100	400	38	48	20		12,37
192 8M 30	42030192	4	GG	192	488,92	487,55		100	460	38	48	20		14,31



PULEGGE DENTATE PER CINGHIE HTD®

HTD® TIMING BELT PULLEYS

8M

PASSO 8 mm

PER CINGHIE LARGHEZZA 50 mm

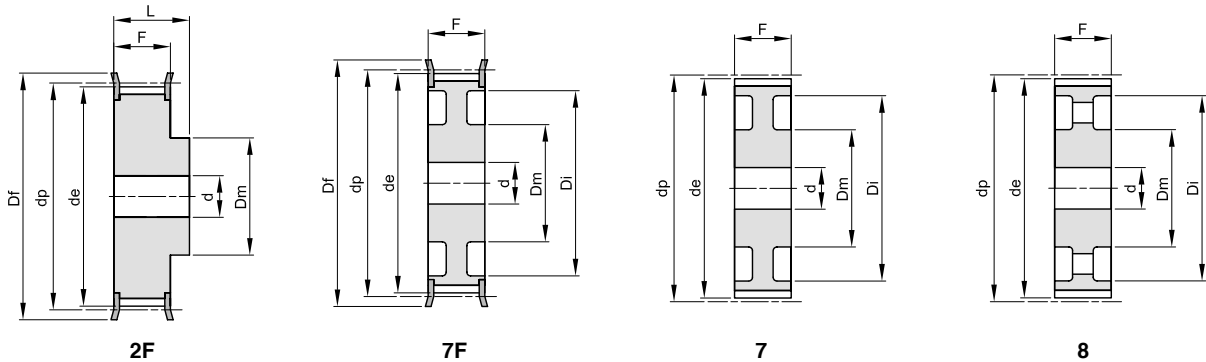

Materiale: Acciaio (St)
Materiale: Ghisa (GG)

descrizione	codice	tipo	materiale	denti	dp	de	Df	Dm	Di	F	L	d	n° flangia	Kg.
22 8M 50	42050022	2F	St	22	56,02	54,65	60	43		60	70	12	308	1,10
24 8M 50	42050024	2F	St	24	61,11	59,74	66	45		60	70	12	310	1,30
26 8M 50	42050026	2F	St	26	66,21	64,84	71	48		60	70	12	311	1,60
28 8M 50	42050028	2F	St	28	71,30	70,08	75	50		60	70	14	312	1,70
30 8M 50	42050030	2F	St	30	76,39	75,13	83	55		60	70	14	314	2,00
32 8M 50	42050032	2F	St	32	81,49	80,16	87	60		60	70	14	315	2,35
34 8M 50	42050034	2F	St	34	86,58	85,21	91	66		60	70	14	316	2,80
36 8M 50	42050036	2F	St	36	91,67	90,30	98	70		60	70	14	319	3,10
38 8M 50	42050038	2F	St	38	96,77	95,39	103	75		60	70	14	320	3,30
40 8M 50	42050040	2F	St	40	101,86	100,49	106	75		60	70	14	321	3,60
44 8M 50	42050044	2F	St	44	112,05	110,67	119	75		60	70	14	325	4,40
48 8M 50	42050048	2F	St	48	122,23	120,86	127	75		60	70	14	327	5,00
56 8M 50	42050056	7F	St	56	142,60	141,23	148	90	116	60	60	18	333	5,68
64 8M 50	42050064	7F	St	64	162,97	161,60	168	100	137	60	60	18	338	6,93
72 8M 50	42050072	7F	St	72	183,35	181,97	192	100	158	60	60	18	340	7,95
80 8M 50	42050080	7	GG	80	203,72	202,35		110	180	60	60	18		7,96
90 8M 50	42050090	7	GG	90	229,18	227,81		110	204	60	60	18		9,20
112 8M 50	42050112	8	GG	112	285,21	283,83		110	254	60	60	18		12,16
144 8M 50	42050144	8	GG	144	366,69	365,32		110	336	60	60	20		15,68
168 8M 50	42050168	8	GG	168	427,81	426,44		120	400	60	60	20		18,99
192 8M 50	42050192	8	GG	192	488,92	487,55		130	460	60	60	20		24,09



PULEGGE DENTATE PER CINGHIE HTD®

HTD® TIMING BELT PULLEYS

8M

PASSO 8 mm

PER CINGHIE LARGHEZZA 85 mm

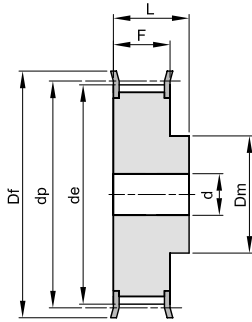

2F

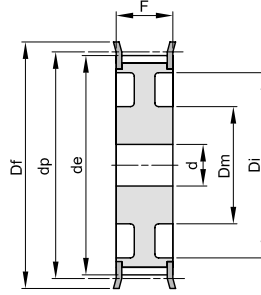

7F

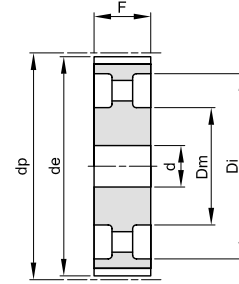

8

Materiale: Acciaio (St)
Materiale: Ghisa (GG)

descrizione	codice	tipo	materiale	denti	dp	de	Df	Dm	Di	F	L	d	n° flangia	Kg.
22 8M 85	42085022	2F	St	22	56,02	54,65	60	43		95	105	12	308	1,60
24 8M 85	42085024	2F	St	24	61,11	59,74	66	45		95	105	12	310	1,95
26 8M 85	42085026	2F	St	26	66,21	64,84	71	48		95	105	12	311	2,30
28 8M 85	42085028	2F	St	28	71,30	70,08	75	50		95	105	14	312	2,60
30 8M 85	42085030	2F	St	30	76,39	75,13	83	55		95	105	14	314	3,10
32 8M 85	42085032	2F	St	32	81,49	80,16	87	60		95	105	14	315	3,70
34 8M 85	42085034	2F	St	34	86,58	85,21	91	66		95	105	14	316	4,00
36 8M 85	42085036	2F	St	36	91,67	90,30	98	70		95	105	14	319	4,70
38 8M 85	42085038	2F	St	38	96,77	95,39	103	75		95	105	14	320	5,10
40 8M 85	42085040	2F	St	40	101,86	100,49	106	75		95	105	14	321	5,40
44 8M 85	42085044	2F	St	44	112,05	110,67	119	75		95	105	14	325	6,70
48 8M 85	42085048	2F	St	48	122,23	120,86	127	75		95	105	14	327	8,20
56 8M 85	42085056	2F	St	56	142,60	141,23	148	90		95	105	18	333	11,48
64 8M 85	42085064	7F	St	64	162,97	161,60	168	100	137	95	95	18	338	11,02
72 8M 85	42085072	7F	St	72	183,35	181,97	192	100	158	95	95	18	340	13,45
80 8M 85	42085080	8	GG	80	203,72	202,35		110	180	95	95	20		12,36
90 8M 85	42085090	8	GG	90	229,18	227,81		110	204	95	95	20		14,38
112 8M 85	42085112	8	GG	112	285,21	283,83		110	254	95	95	24		18,66
144 8M 85	42085144	8	GG	144	366,69	365,32		110	341	95	95	24		23,00
* 168 8M 85	42085168	8	GG	168	427,81	426,44		120	400	95	95	24		
* 192 8M 85	42085192	8	GG	192	488,92	487,55		130	460	95	95	24		

* Costruite a richiesta / Manufactured on request



PULEGGE DENTATE PER CINGHIE HTD®

HTD® TIMING BELT PULLEYS

14M

PASSO 14 mm

PER CINGHIE LARGHEZZA 40 mm

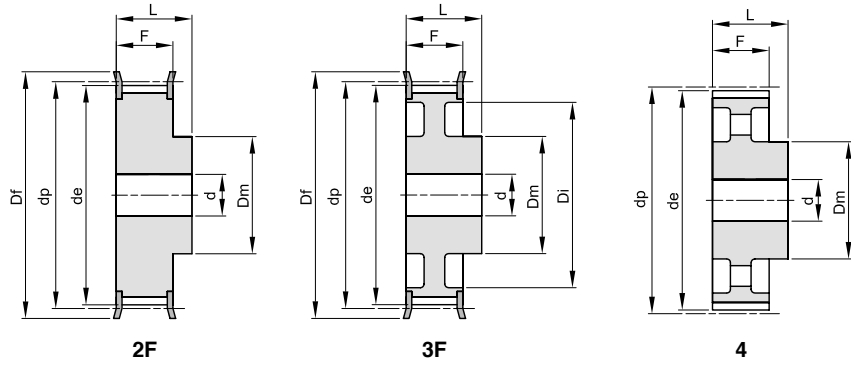

Materiale: Acciaio (St)
Materiale: Ghisa (GG)

descrizione	codice	tipo	materiale	denti	dp	de	Df	Dm	Di	F	L	d	n° flangia	Kg.
28 14M 40	43040028	2F	St	28	124,78	122,12	127	100		54	69	24	400	4,80
30 14M 40	43040030	2F	St	30	133,69	130,99	138	100		54	69	24	401	5,60
32 14M 40	43040032	2F	St	32	142,60	139,88	154	100		54	69	24	403	6,20
34 14M 40	43040034	2F	St	34	151,52	148,79	160	100		54	69	24	404	6,90
36 14M 40	43040036	2F	St	36	160,43	157,68	168	100		54	69	24	405	7,70
38 14M 40	43040038	2F	St	38	169,34	166,60	183	120		54	69	24	406	8,90
40 14M 40	43040040	2F	St	40	178,25	175,49	188	120		54	69	24	407	9,80
44 14M 40	43040044	2F	St	44	196,08	193,28	211	120		54	69	24	411	12,00
48 14M 40	43040048	3F	GG	48	213,90	211,11	226	135	170	54	69	24	412	11,98
56 14M 40	43040056	3F	GG	56	249,55	246,76	256	135	207	54	69	28	416	14,01
64 14M 40	43040064	3F	GG	64	285,21	282,41	296	135	240	54	69	28	418	16,65
72 14M 40	43040072	4	GG	72	320,86	318,06		135	278	54	69	28		15,52
80 14M 40	43040080	4	GG	80	356,51	353,71		135	314	54	69	28		17,23
90 14M 40	43040090	4	GG	90	401,07	398,28		135	358	54	69	28		19,40
112 14M 40	43040112	4	GG	112	499,11	496,32		135	456	54	69	28		24,14
* 144 14M 40	43040144	4	GG	144	641,71	638,92		135	600	54	69	28		
* 168 14M 40	43040168	4	GG	168	748,66	745,87		135	706	54	69	28		
* 192 14M 40	43040192	4	GG	192	855,62	852,82		135	813	54	69	28		

* Costruite a richiesta / Manufactured on request



PULEGGE DENTATE PER CINGHIE HTD®

HTD® TIMING BELT PULLEYS

14M

PASSO 14 mm

PER CINGHIE LARGHEZZA 55 mm

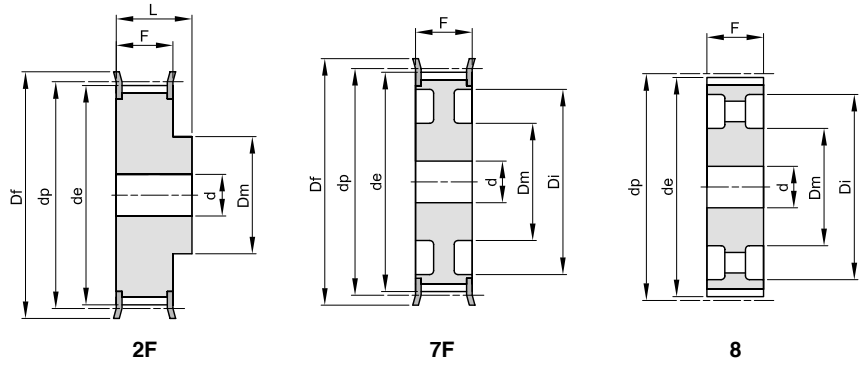

Materiale: Acciaio (St)
Materiale: Ghisa (GG)

descrizione	codice	tipo	materiale	denti	dp	de	Df	Dm	Di	F	L	d	n° flangia	Kg.
28 14M 55	43055028	2F	St	28	124,78	122,12	127	100		70	85	24	400	5,70
30 14M 55	43055030	2F	St	30	133,69	130,99	138	100		70	85	24	401	7,10
32 14M 55	43055032	2F	St	32	142,60	139,88	154	100		70	85	24	403	7,90
34 14M 55	43055034	2F	St	34	151,52	148,79	160	100		70	85	24	404	9,33
36 14M 55	43055036	2F	St	36	160,43	157,68	168	100		70	85	24	405	10,49
38 14M 55	43055038	2F	St	38	169,34	166,60	183	120		70	85	24	406	12,11
40 14M 55	43055040	2F	St	40	178,25	175,49	188	120		70	85	24	407	13,30
44 14M 55	43055044	2F	St	44	196,08	193,28	211	120		70	85	24	411	16,12
48 14M 55	43055048	7F	GG	48	213,90	211,11	226	135	170	70	70	24	412	13,50
56 14M 55	43055056	7F	GG	56	249,55	246,76	256	135	207	70	70	28	416	15,78
64 14M 55	43055064	7F	GG	64	285,21	282,41	296	135	240	70	70	28	418	19,04
72 14M 55	43055072	8	GG	72	320,86	318,06		135	278	70	70	28		18,41
80 14M 55	43055080	8	GG	80	356,51	353,71		135	314	70	70	28		20,27
90 14M 55	43055090	8	GG	90	401,07	398,28		135	358	70	70	28		22,98
112 14M 55	43055112	8	GG	112	499,11	496,32		135	456	70	70	28		29,29
144 14M 55	43055144	8	GG	144	641,71	638,92		135	600	70	70	28		36,00
168 14M 55	43055168	8	GG	168	748,66	745,87		135	706	70	70	28		40,00
192 14M 55	43055192	8	GG	192	855,62	852,82		135	813	70	70	28		67,00



PULEGGE DENTATE PER CINGHIE HTD®

HTD® TIMING BELT PULLEYS

14M

PASSO 14 mm

PER CINGHIE LARGHEZZA 85 mm

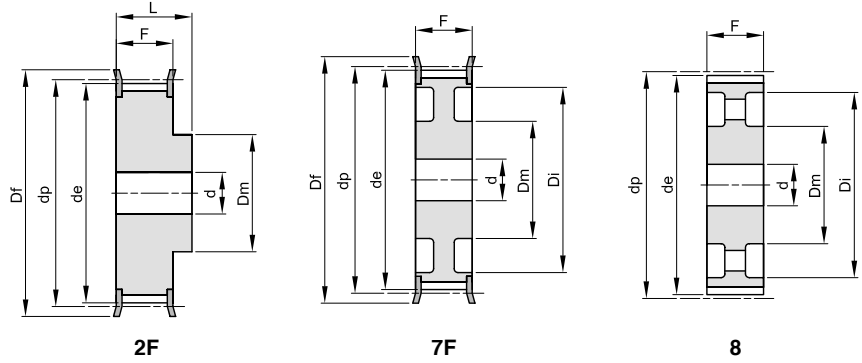

Materiale: Acciaio (St)
Materiale: Ghisa (GG)

descrizione	codice	tipo	materiale	denti	dp	de	Df	Dm	Di	F	L	d	n° flangia	Kg.
28 14M 85	43085028	2F	St	28	124,78	122,12	127	100		102	117	24	400	8,77
30 14M 85	43085030	2F	St	30	133,69	130,99	138	100		102	117	24	401	10,13
32 14M 85	43085032	2F	St	32	142,60	139,88	154	100		102	117	24	403	11,65
34 14M 85	43085034	2F	St	34	151,52	148,79	160	100		102	117	24	404	13,15
36 14M 85	43085036	2F	St	36	160,43	157,68	168	100		102	117	32	405	14,48
38 14M 85	43085038	2F	St	38	169,34	166,60	183	120		102	117	32	406	16,62
40 14M 85	43085040	2F	St	40	178,25	175,49	188	135		102	117	32	407	18,84
44 14M 85	43085044	2F	St	44	196,08	193,28	211	135		102	117	32	411	22,86
48 14M 85	43085048	2F	St	48	213,90	211,11	226	150		102	117	32	412	27,00
56 14M 85	43085056	7F	GG	56	249,55	246,76	256	150	207	102	102	32	416	24,19
64 14M 85	43085064	7F	GG	64	285,21	282,41	296	150	240	102	102	32	418	28,57
72 14M 85	43085072	8	GG	72	320,86	318,06		150	278	102	102	32		28,26
80 14M 85	43085080	8	GG	80	356,51	353,71		150	314	102	102	32		31,00
90 14M 85	43085090	8	GG	90	401,07	398,28		150	358	102	102	32		35,00
112 14M 85	43085112	8	GG	112	499,11	496,32		150	456	102	102	32		43,50
144 14M 85	43085144	8	GG	144	641,71	638,92		150	600	102	102	32		60,00
168 14M 85	43085168	8	GG	168	748,66	745,87		150	706	102	102	32		63,00
192 14M 85	43085192	8	GG	192	855,62	852,82		165	813	102	102	32		76,00



PULEGGE DENTATE PER CINGHIE HTD®

HTD® TIMING BELT PULLEYS

14M

PASSO 14 mm

PER CINGHIE LARGHEZZA 115 mm

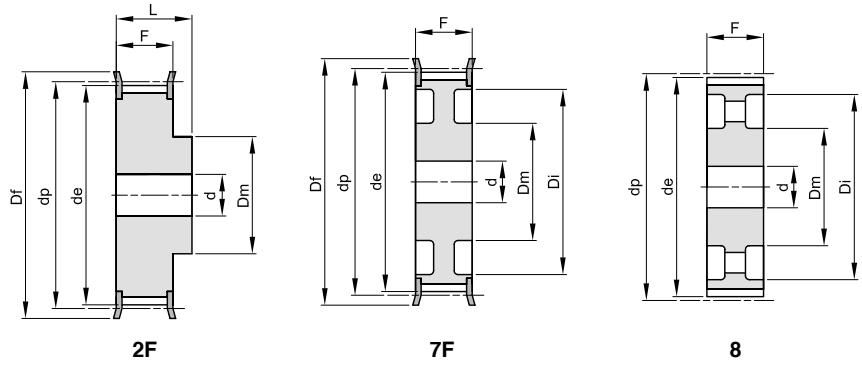

Materiale: Acciaio (St)
Materiale: Ghisa (GG)

descrizione	codice	tipo	materiale	denti	dp	de	Df	Dm	Di	F	L	d	n° flangia	Kg.
28 14M 115	43115028	2F	St	28	124,78	122,12	127	100		133	148	32	400	10,75
30 14M 115	43115030	2F	St	30	133,69	130,99	138	100		133	148	32	401	12,52
32 14M 115	43115032	2F	St	32	142,60	139,88	154	100		133	148	32	403	14,48
34 14M 115	43115034	2F	St	34	151,52	148,79	160	100		133	148	32	404	16,45
36 14M 115	43115036	2F	St	36	160,43	157,68	168	120		133	148	32	405	18,99
38 14M 115	43115038	2F	St	38	169,34	166,60	183	120		133	148	32	406	21,31
40 14M 115	43115040	2F	St	40	178,25	175,49	188	135		133	148	32	407	24,04
44 14M 115	43115044	2F	St	44	196,08	193,28	211	140		133	148	32	411	29,41
48 14M 115	43115048	2F	St	48	213,90	211,11	226	150		133	148	32	412	35,00
56 14M 115	43115056	2F	St	56	249,55	246,76	256	150		133	148	32	416	48,00
64 14M 115	43115064	7F	GG	64	285,21	282,41	296	150	240	133	133	32	418	36,00
72 14M 115	43115072	8	GG	72	320,86	318,06		150	278	133	133	32		36,00
80 14M 115	43115080	8	GG	80	356,51	353,71		150	314	133	133	32		40,00
90 14M 115	43115090	8	GG	90	401,07	398,28		150	358	133	133	32		45,00
112 14M 115	43115112	8	GG	112	499,11	496,32		150	456	133	133	32		55,50
144 14M 115	43115144	8	GG	144	641,71	638,92		165	600	133	133	32		71,00
168 14M 115	43115168	8	GG	168	748,66	745,87		165	706	133	133	32		83,00
192 14M 115	43115192	8	GG	192	855,62	852,82		165	813	133	133	32		96,00



PULEGGE DENTATE PER CINGHIE HTD®

HTD® TIMING BELT PULLEYS

14M

PASSO 14 mm

PER CINGHIE LARGHEZZA 170 mm

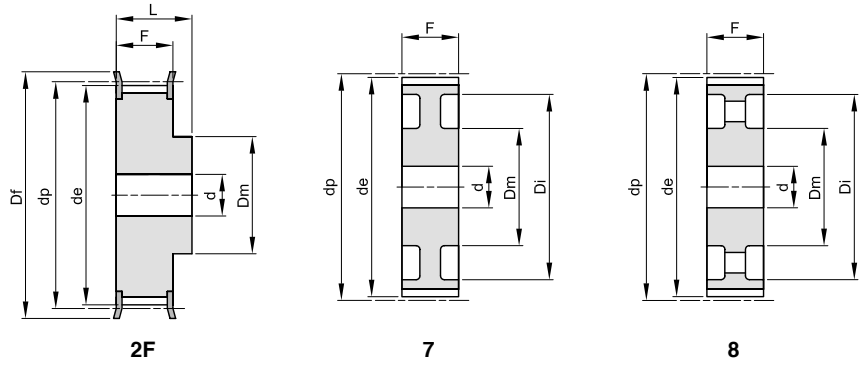

Materiale: Acciaio (St)
Materiale: Ghisa (GG)

descrizione	codice	tipo	materiale	denti	dp	de	Df	Dm	Di	F	L	d	n° flangia	Kg.
28 14M 170	43170028	2F	St	28	124,78	122,12	127	100		187	202	32	400	14,79
30 14M 170	43170030	2F	St	30	133,69	130,99	138	100		187	202	32	401	17,24
32 14M 170	43170032	2F	St	32	142,60	139,88	154	100		187	202	32	403	19,92
34 14M 170	43170034	2F	St	34	151,52	148,79	160	100		187	202	32	404	22,72
36 14M 170	43170036	2F	St	36	160,43	157,68	168	120		187	202	32	405	26,07
38 14M 170	43170038	2F	St	38	169,34	166,60	183	135		187	202	32	406	29,71
40 14M 170	43170040	2F	St	40	178,25	175,49	188	140		187	202	32	407	33,00
* 44 14M 170	43170044	2F	St	44	196,08	193,28	211	160		187	202	32	411	
* 48 14M 170	43170048	2F	St	48	213,90	211,11	226	160		187	202	32	412	
* 56 14M 170	43170056	2F	St	56	249,55	246,76	256	160		187	202	32	416	
* 64 14M 170	43170064	2F	St	64	285,21	282,41	296	180		187	202	32	418	
* 72 14M 170	43170072	7	GG	72	320,86	318,06		180	278	187	187	32		
80 14M 170	43170080	7	GG	80	356,51	353,71		180	314	187	187	32		71,00
90 14M 170	43170090	8	GG	90	401,07	398,28		180	358	187	187	38		73,00
112 14M 170	43170112	8	GG	112	499,11	496,32		200	456	187	187	38		95,00
144 14M 170	43170144	8	GG	144	641,71	638,92		220	600	187	187	38		114,00
168 14M 170	43170168	8	GG	168	748,66	745,87		220	706	187	187	38		142,00
* 192 14M 170	43170192	8	GG	192	855,62	852,82		220	813	187	187	38		

* Costruite a richiesta / Manufactured on request



PULEGGE DENTATE A BUSSOLA CONICA PER CINGHIE HTD®

HTD® TIMING BELT PULLEYS FOR TAPER BUSHES

5M

PASSO 5 mm

PER CINGHIE LARGHEZZA 15 mm

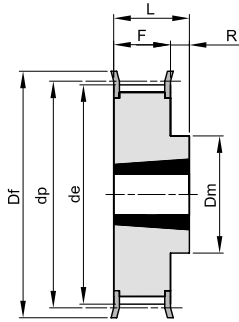

10F

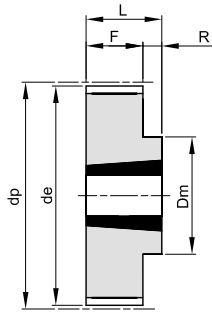

10

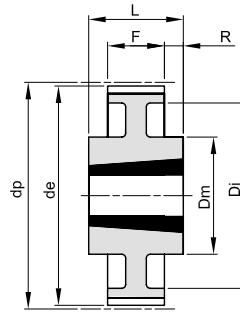

13

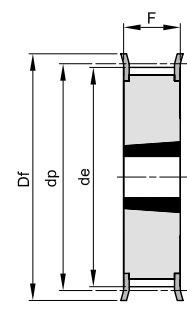

15F

Materiale: Acciaio (St)

descrizione	codice	tipo	materiale	denti	bussola	foro max	dp	de	Df	Dm	Di	F	L	R	n° flangia	Kg.
TL 34 5M 15	46015034	15F	St	34	1008	25	54,11	52,97	57			22	22		213	0,20
TL 36 5M 15	46015036	15F	St	36	1108	28	57,30	56,15	60			22	22		214	0,25
TL 38 5M 15	46015038	15F	St	38	1108	28	60,48	59,34	66			22	22		216	0,30
TL 40 5M 15	46015040	15F	St	40	1108	28	63,66	62,52	71			22	22		217	0,35
TL 44 5M 15	46015044	15F	St	44	1108	28	70,03	68,89	75			22	22		218	0,40
TL 48 5M 15	46015048	10F	St	48	1210	32	76,39	75,25	83	59		22	25	3	219	0,46
TL 56 5M 15	46015056	10F	St	56	1210	32	89,13	87,99	93	70		22	25	3	222	0,60
TL 64 5M 15	46015064	10F	St	64	1210	32	101,86	100,72	106	80		22	25	3	224	0,80
TL 72 5M 15	46015072	10	St	72	1610	42	114,59	113,45		92		22	25	3		1,20
TL 80 5M 15	46015080	10	St	80	1610	42	127,32	126,18		92		22	25	3		1,76
TL 90 5M 15	46015090	10	St	90	1610	42	143,24	142,10		92		22	25	3		2,32
TL112 5M 15	46015112	10	St	112	2012	50	178,25	177,11		110		20	32	12		3,72
TL136 5M 15	46015136	13	St	136	2012	50	216,45	215,31		110	199	20	32	6		3,82



PULEGGE DENTATE A BUSSOLA CONICA PER CINGHIE HTD®

HTD® TIMING BELT PULLEYS FOR TAPER BUSHES

8M

PASSO 8 mm

PER CINGHIE LARGHEZZA 20 mm

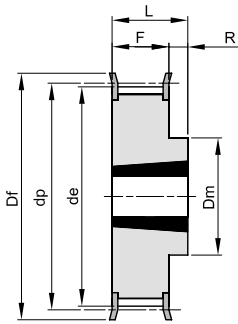

10F

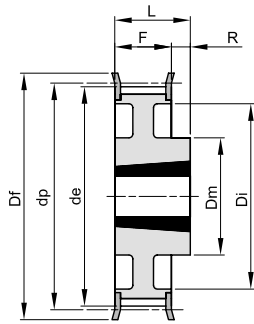

11F

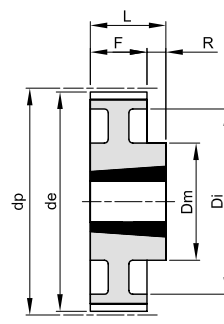

11

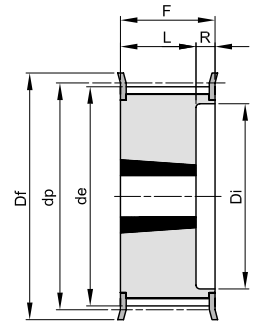

16F

Materiale: Acciaio (St)
Materiale: Ghisa (GG)

descrizione	codice	tipo	materiale	denti	bussola	foro max	dp	de	Df	Dm	Di	F	L	R	n° flangia	Kg.
TL 22 8M 20	47020022	16F	St	22	1008	25	56,02	54,65	60		37	28	22	6	308	0,25
TL 24 8M 20	47020024	16F	St	24	1108	28	61,11	59,74	66		44	28	22	6	310	0,30
TL 26 8M 20	47020026	16F	St	26	1108	28	66,21	64,84	71		45	28	22	6	311	0,36
TL 28 8M 20	47020028	16F	St	28	1108	28	71,30	70,08	75		50	28	22	6	312	0,45
TL 30 8M 20	47020030	16F	St	30	1108	28	76,39	75,13	83		58	28	22	6	314	0,55
TL 32 8M 20	47020032	16F	St	32	1610	42	81,49	80,16	87		63	28	25	3	315	0,43
TL 34 8M 20	47020034	16F	St	34	1610	42	86,58	85,21	91		64	28	25	3	316	0,57
TL 36 8M 20	47020036	16F	St	36	1610	42	91,67	90,30	98		68	28	25	3	319	0,70
TL 38 8M 20	47020038	16F	St	38	1610	42	96,77	95,39	103		72	28	25	3	320	0,82
TL 40 8M 20	47020040	16F	St	40	1610	42	101,86	100,49	106		76	28	25	3	321	1,10
TL 44 8M 20	47020044	10F	St	44	2012	50	112,05	110,67	119	92		28	32	4	325	1,20
TL 48 8M 20	47020048	10F	St	48	2012	50	122,23	120,86	127	96		28	32	4	327	1,65
TL 56 8M 20	47020056	10F	St	56	2012	50	142,60	141,23	148	110		28	32	4	333	2,50
TL 64 8M 20	47020064	11F	St	64	2012	50	162,97	161,60	168	110	137	28	32	4	338	2,60
TL 72 8M 20	47020072	11F	St	72	2012	50	183,35	181,97	192	110	158	28	32	4	340	3,40
TL 80 8M 20	47020080	11	GG	80	2012	50	203,72	202,35		110	180	28	32	4		3,60
TL 90 8M 20	47020090	11	GG	90	2012	50	229,18	227,81		110	204	28	32	4		4,10



PULEGGE DENTATE A BUSSOLA CONICA PER CINGHIE HTD®

HTD® TIMING BELT PULLEYS FOR TAPER BUSHES

8M

PASSO 8 mm

PER CINGHIE LARGHEZZA 30 mm

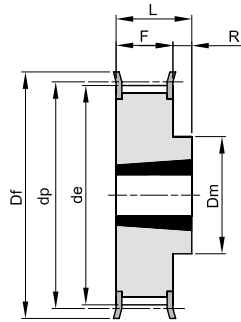

10F

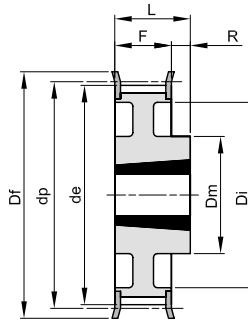

11F

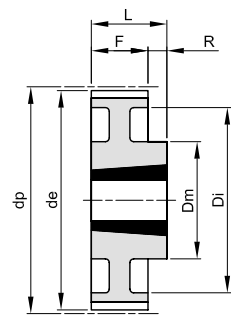

11

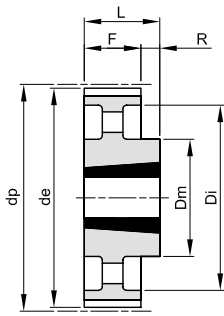

12

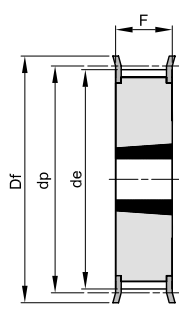

15F

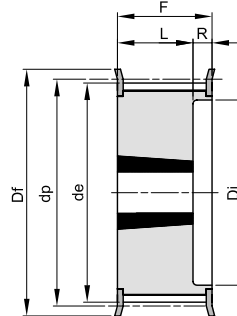

16F

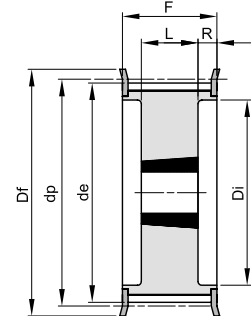

18F

Materiale: Acciaio (St)
Materiale: Ghisa (GG)

descrizione	codice	tipo	materiale	denti	bussola	foro max	dp	de	Df	Dm	Di	F	L	R	n° flangia	Kg.
TL 22 8M 30	47030022	16F	St	22	1008	25	56,02	54,65	60		37	38	22	16	308	0,33
TL 24 8M 30	47030024	16F	St	24	1108	28	61,11	59,74	66		44	38	22	16	310	0,40
TL 26 8M 30	47030026	16F	St	26	1108	28	66,21	64,84	71		44	38	22	16	311	0,45
TL 28 8M 30	47030028	16F	St	28	1210	32	71,30	70,08	75		50	38	25	13	312	0,50
TL 30 8M 30	47030030	15F	St	30	1615	42	76,39	75,13	83			38	38		314	0,55
TL 32 8M 30	47030032	15F	St	32	1615	42	81,49	80,16	87			38	38		315	0,60
TL 34 8M 30	47030034	15F	St	34	1615	42	86,58	85,21	91			38	38		316	0,80
TL 36 8M 30	47030036	15F	St	36	1615	42	91,67	90,30	98			38	38		319	1,00
TL 38 8M 30	47030038	15F	St	38	1615	42	96,77	95,39	103			38	38		320	1,10
TL 40 8M 30	47030040	15F	St	40	1615	42	101,86	100,49	106			38	38		321	1,34
TL 44 8M 30	47030044	18F	St	44	2012	50	112,05	110,67	119		86	38	32	3	325	1,30
TL 48 8M 30	47030048	18F	St	48	2012	50	122,23	120,86	127		90	38	32	3	327	1,80
TL 56 8M 30	47030056	18F	St	56	2012	50	142,60	141,23	148		110	38	32	3	333	3,80
TL 64 8M 30	47030064	10F	St	64	2517	60	162,97	161,60	168	125		38	45	7	338	4,30
TL 72 8M 30	47030072	11F	St	72	2517	60	183,35	181,97	192	125	158	38	45	7	340	4,40
TL 80 8M 30	47030080	11	GG	80	2517	60	203,72	202,35		125	180	38	45	7		4,65
TL 90 8M 30	47030090	11	GG	90	2517	60	229,18	227,81		125	204	38	45	7		5,80
TL112 8M 30	47030112	12	GG	112	2517	60	285,21	283,83		125	254	38	45	7		6,20
TL144 8M 30	47030144	12	GG	144	2517	60	366,69	365,32		125	336	38	45	7		9,00



PULEGGE DENTATE A BUSSOLA CONICA PER CINGHIE HTD®

HTD® TIMING BELT PULLEYS FOR TAPER BUSHES

8M

PASSO 8 mm

PER CINGHIE LARGHEZZA 50 mm

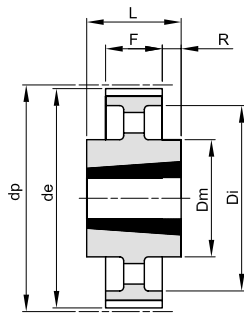

14

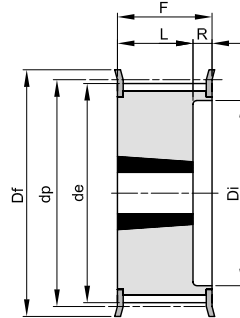

16F

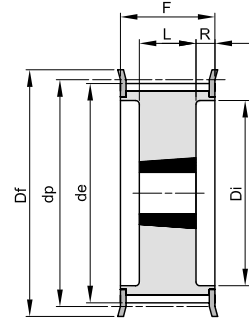

18F

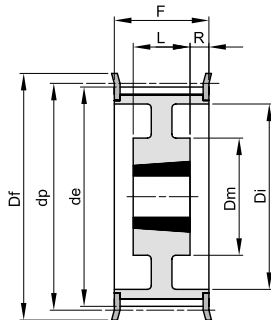

19F

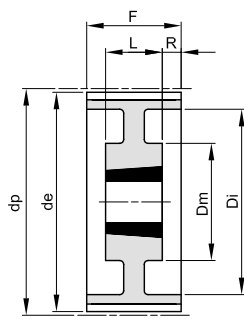

19

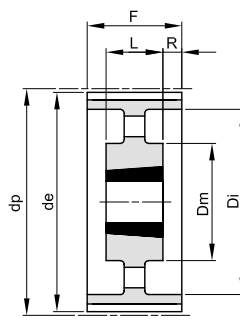

20

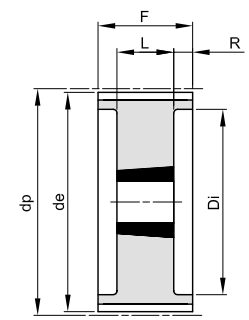

18

Materiale: Acciaio (St)
Materiale: Ghisa (GG)

descrizione	codice	tipo	materiale	denti	bussola	foro max	dp	de	Df	Dm	Di	F	L	R	n° flangia	Kg.
TL 28 8M 50	47050028	16F	St	28	1210	32	71,30	70,08	75		50	60	25	35	312	0,60
TL 30 8M 50	47050030	16F	St	30	1615	42	76,39	75,13	83		58	60	38	22	314	0,65
TL 32 8M 50	47050032	16F	St	32	1615	42	81,49	80,16	87		63	60	38	22	315	0,80
TL 34 8M 50	47050034	16F	St	34	1615	42	86,58	85,21	91		65	60	38	22	316	1,08
TL 36 8M 50	47050036	16F	St	36	1615	42	91,67	90,30	98		68	60	38	22	319	1,35
TL 38 8M 50	47050038	16F	St	38	1615	42	96,77	95,39	103		72	60	38	22	320	1,65
TL 40 8M 50	47050040	18F	St	40	2012	50	101,86	100,49	106		80	60	32	14	321	1,70
TL 44 8M 50	47050044	18F	St	44	2012	50	112,05	110,67	119		86	60	32	14	325	1,80
TL 48 8M 50	47050048	18F	St	48	2012	50	122,23	120,86	127		95	60	32	14	327	2,35
TL 56 8M 50	47050056	18F	St	56	2517	60	142,60	141,23	148		116	60	45	7,5	333	3,35
TL 64 8M 50	47050064	18F	St	64	2517	60	162,97	161,60	168		136	60	45	7,5	338	4,90
TL 72 8M 50	47050072	19F	St	72	2517	60	183,35	181,97	192	125	158	60	45	7,5	340	6,90
TL 80 8M 50	47050080	18	GG	80	3020	75	203,72	202,35			180	60	51	4,5		8,90
TL 90 8M 50	47050090	19	GG	90	3020	75	229,18	227,81		160	204	60	51	4,5		9,90
TL112 8M 50	47050112	19	GG	112	3020	75	285,21	283,83		170	254	60	51	4,5		12,10
TL144 8M 50	47050144	20	GG	144	3020	75	366,69	365,32		170	336	60	51	4,5		15,40
TL168 8M 50	47050168	14	GG	168	3525	90	427,81	426,44		198	395	60	65	2,5		22,80
TL192 8M 50	47050192	14	GG	192	3525	90	488,92	487,55		198	455	60	65	2,5		26,50



PULEGGE DENTATE A BUSSOLA CONICA PER CINGHIE HTD®

HTD® TIMING BELT PULLEYS FOR TAPER BUSHES

8M

PASSO 8 mm

PER CINGHIE LARGHEZZA 85 mm

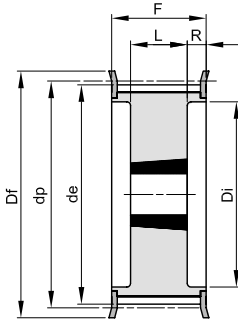

18F

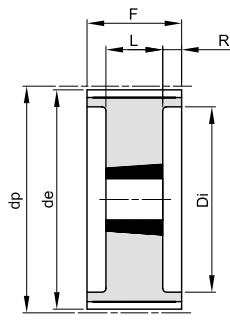

18

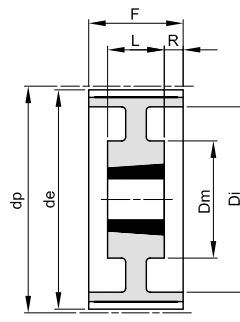

19

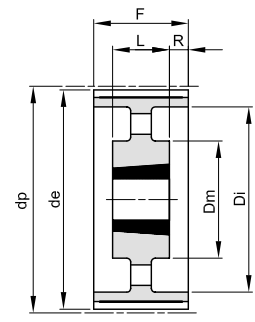

20

Materiale: Acciaio (St)
Materiale: Ghisa (GG)

descrizione	codice	tipo	materiale	denti	bussola	foro max	dp	de	Df	Dm	Di	F	L	R	n° flangia	Kg.
TL 34 8M 85	47085034	18F	St	34	1615	42	86,58	85,22	91		65	95	38	28,5	316	1,50
TL 36 8M 85	47085036	18F	St	36	1615	42	91,67	90,30	98		68	95	38	28,5	319	1,90
TL 38 8M 85	47085038	18F	St	38	1615	42	96,77	95,39	103		72	95	38	28,5	320	2,20
TL 40 8M 85	47085040	18F	St	40	2012	50	101,86	100,49	106		80	95	32	31,5	321	1,90
TL 44 8M 85	47085044	18F	St	44	2012	50	112,05	110,67	119		86	95	32	31,5	325	2,30
TL 48 8M 85	47085048	18F	St	48	2517	60	122,23	120,86	127		97	95	45	25	327	2,70
TL 56 8M 85	47085056	18F	St	56	2517	60	142,60	141,23	148		116	95	45	25	333	4,50
TL 64 8M 85	47085064	18F	St	64	2517	60	162,97	161,60	168		136	95	45	25	338	6,30
TL 72 8M 85	47085072	18F	St	72	3020	75	183,35	181,97	192		150	95	51	22	340	8,10
TL 80 8M 85	47085080	18	GG	80	3020	75	203,72	202,35			180	95	51	22		10,20
TL 90 8M 85	47085090	19	GG	90	3020	75	229,18	227,81		170	204	95	51	22		11,20
TL112 8M 85	47085112	19	GG	112	3020	75	285,21	283,83		170	254	95	51	22		15,00
TL144 8M 85	47085144	20	GG	144	3525	90	366,69	365,32		198	336	95	65	15		20,20
TL168 8M 85	47085168	20	GG	168	3525	90	427,81	426,44		198	395	95	65	15		22,40
TL192 8M 85	47085192	20	GG	192	3525	90	488,92	487,55		198	455	95	65	15		28,20



PULEGGE DENTATE A BUSSOLA CONICA PER CINGHIE HTD®

HTD® TIMING BELT PULLEYS FOR TAPER BUSHES

14M

PASSO 14 mm

PER CINGHIE LARGHEZZA 40 mm

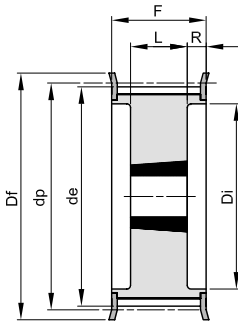

18F

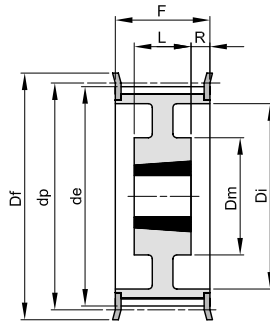

19F

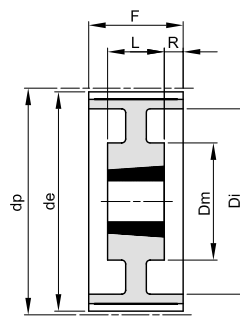

19

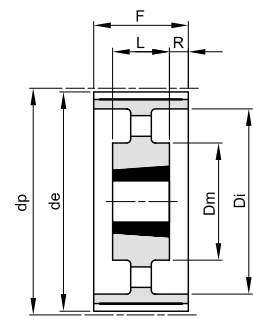

20

Materiale: Acciaio (St)
Materiale: Ghisa (GG)

descrizione	codice	tipo	materiale	denti	bussola	foro max	dp	de	Df	Dm	Di	F	L	R	n° flangia	Kg.
TL 28 14M 40	48040028	18F	St	28	2012	50	124,78	122,12	127		94	54	32	11	400	2,10
TL 30 14M 40	48040030	18F	St	30	2012	50	133,69	130,99	138		98	54	32	11	401	2,70
TL 32 14M 40	48040032	18F	St	32	2012	50	142,60	139,88	154		108	54	32	11	403	3,40
TL 34 14M 40	48040034	18F	St	34	2517	60	151,52	148,79	160		110	54	45	4,5	404	3,90
TL 36 14M 40	48040036	18F	St	36	2517	60	160,43	157,68	168		120	54	45	4,5	405	4,80
TL 38 14M 40	48040038	18F	St	38	2517	60	169,34	166,60	183		130	54	45	4,5	406	5,40
TL 40 14M 40	48040040	18F	St	40	2517	60	178,25	175,49	188		138	54	45	4,5	407	6,00
TL 44 14M 40	48040044	18F	St	44	3020	75	196,08	193,28	211		155	54	51	1,5	411	7,70
TL 48 14M 40	48040048	18F	St	48	3020	75	213,90	211,11	226		170	54	51	1,5	412	9,90
TL 56 14M 40	48040056	18F	GG	56	3020	75	249,55	246,76	256		208	54	51	1,5	416	10,70
TL 64 14M 40	48040064	19F	GG	64	3020	75	285,21	282,41	296	170	240	54	51	1,5	418	13,30
TL 72 14M 40	48040072	19	GG	72	3020	75	320,86	318,06		170	280	54	51	1,5		15,00
TL 80 14M 40	48040080	20	GG	80	3020	75	356,51	353,71		170	315	54	51	1,5		16,00
TL 90 14M 40	48040090	20	GG	90	3020	75	401,07	398,28		170	360	54	51	1,5		18,00
TL112 14M 40	48040112	20	GG	112	3020	75	499,11	496,32		170	457	54	51	1,5		25,50
TL144 14M 40	48040144	20	GG	144	3020	75	641,71	638,92		170	600	54	51	1,5		32,00
TL168 14M 40	48040168	20	GG	168	3020	75	748,66	745,87		170	706	54	51	1,5		43,50
TL192 14M 40	48040192	20	GG	192	3020	75	855,62	852,82		170	813	54	51	1,5		49,50



PULEGGE DENTATE A BUSSOLA CONICA PER CINGHIE HTD®

HTD® TIMING BELT PULLEYS FOR TAPER BUSHES

14M

PASSO 14 mm

PER CINGHIE LARGHEZZA 55 mm

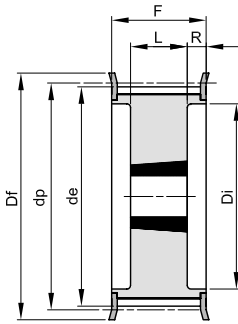

18F

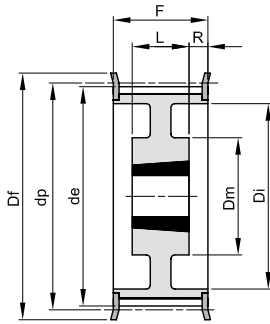

19F

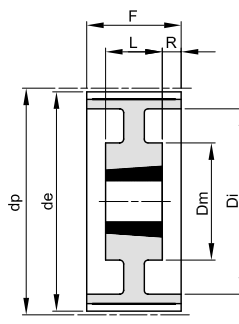

19

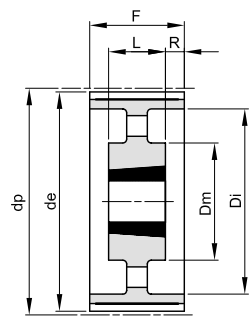

20

Materiale: Acciaio (St)
Materiale: Ghisa (GG)

descrizione	codice	tipo	materiale	denti	bussola	foro max	dp	de	Df	Dm	Di	F	L	R	n° flangia	Kg.
TL 28 14M 55	48055028	18F	St	28	2012	50	124,78	122,12	127		94	70	32	19	400	2,20
TL 30 14M 55	48055030	18F	St	30	2517	60	133,69	130,99	138		100	70	45	12,5	401	2,70
TL 32 14M 55	48055032	18F	St	32	2517	60	142,60	139,88	154		108	70	45	12,5	403	3,60
TL 34 14M 55	48055034	18F	St	34	2517	60	151,52	148,79	160		110	70	45	12,5	404	4,50
TL 36 14M 55	48055036	18F	St	36	2517	60	160,43	157,68	168		120	70	45	12,5	405	5,20
TL 38 14M 55	48055038	18F	St	38	2517	60	169,34	166,60	183		130	70	45	12,5	406	6,20
TL 40 14M 55	48055040	18F	St	40	2517	60	178,25	175,49	188		138	70	45	12,5	407	6,90
TL 44 14M 55	48055044	18F	St	44	3020	75	196,08	193,28	211		155	70	51	9,5	411	8,60
TL 48 14M 55	48055048	18F	St	48	3020	75	213,90	211,11	226		170	70	51	9,5	412	10,50
TL 56 14M 55	48055056	18F	GG	56	3020	75	249,55	246,76	256		208	70	51	9,5	416	12,50
TL 64 14M 55	48055064	19F	GG	64	3020	75	285,21	282,41	296	170	240	70	51	9,5	418	15,60
TL 72 14M 55	48055072	19	GG	72	3020	75	320,86	318,06		170	280	70	51	9,5		17,45
TL 80 14M 55	48055080	20	GG	80	3020	75	356,51	353,71		170	315	70	51	9,5		17,45
TL 90 14M 55	48055090	20	GG	90	3020	75	401,07	398,28		170	360	70	51	9,5		19,90
TL112 14M 55	48055112	20	GG	112	3020	75	499,11	496,32		170	457	70	51	9,5		27,50
TL144 14M 55	48055144	20	GG	144	3020	75	641,71	638,92		170	600	70	51	9,5		37,00
TL168 14M 55	48055168	20	GG	168	3020	75	748,66	745,87		170	706	70	51	9,5		50,00
TL192 14M 55	48055192	20	GG	192	3020	75	855,62	852,82		170	813	70	51	9,5		62,00



PULEGGE DENTATE A BUSSOLA CONICA PER CINGHIE HTD®

HTD® TIMING BELT PULLEYS FOR TAPER BUSHES

14M

PASSO 14 mm

PER CINGHIE LARGHEZZA 85 mm

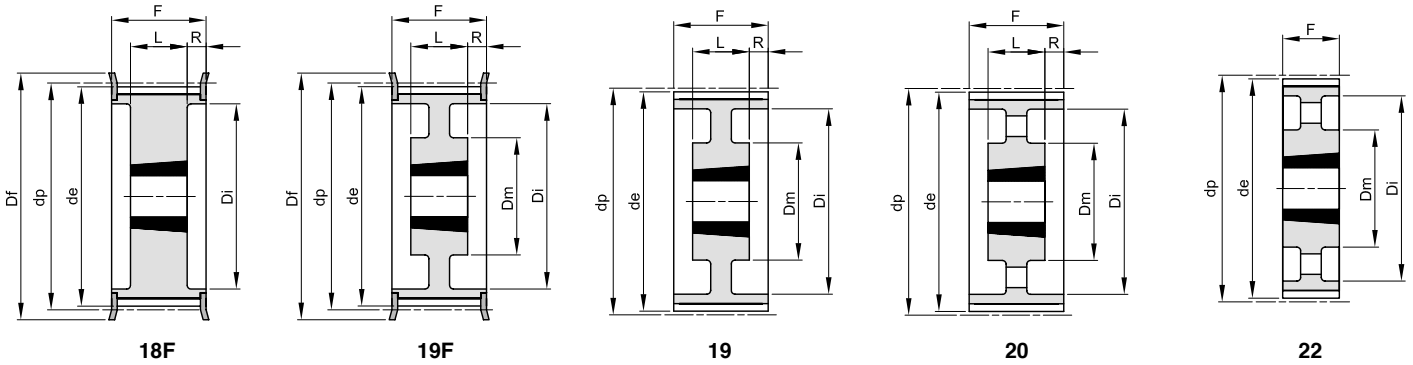

Materiale: Acciaio (St)
Materiale: Ghisa (GG)

descrizione	codice	tipo	materiale	denti	bussola	foro max	dp	de	Df	Dm	Di	F	L	R	n° flangia	Kg.
TL 28 14M 85	48085028	18F	St	28	2517	60	124,78	122,12	127		98	102	45	28,5	400	2,70
TL 30 14M 85	48085030	18F	St	30	2517	60	133,69	130,99	138		100	102	45	28,5	401	3,80
TL 32 14M 85	48085032	18F	St	32	2517	60	142,60	139,88	154		108	102	45	28,5	403	4,70
TL 34 14M 85	48085034	18F	St	34	2517	60	151,52	148,79	160		110	102	45	28,5	404	6,00
TL 36 14M 85	48085036	18F	St	36	3020	75	160,43	157,68	168		125	102	51	25,5	405	5,70
TL 38 14M 85	48085038	18F	St	38	3020	75	169,34	166,60	183		130	102	51	25,5	406	6,80
TL 40 14M 85	48085040	18F	St	40	3020	75	178,25	175,49	188		138	102	51	25,5	407	8,00
TL 44 14M 85	48085044	18F	St	44	3030	75	196,08	193,28	211		155	102	76	13	411	11,70
TL 48 14M 85	48085048	18F	St	48	3030	75	213,90	211,11	226		170	102	76	13	412	15,00
TL 56 14M 85	48085056	18F	GG	56	3525	90	249,55	246,76	256		210	102	65	18,5	416	19,00
TL 64 14M 85	48085064	19F	GG	64	3525	90	285,21	282,41	296	190	240	102	65	18,5	418	23,50
TL 72 14M 85	48085072	19	GG	72	3525	90	320,86	318,06		190	280	102	65	18,5		25,00
TL 80 14M 85	48085080	20	GG	80	3525	90	356,51	353,71		190	315	102	65	18,5		26,00
TL 90 14M 85	48085090	20	GG	90	3525	90	401,07	398,28		190	360	102	65	18,5		28,00
TL112 14M 85	48085112	20	GG	112	3525	90	499,11	496,32		190	457	102	65	18,5		36,00
TL144 14M 85	48085144	20	GG	144	3525	90	641,71	638,92		190	600	102	65	18,5		48,00
TL168 14M 85	48085168	20	GG	168	3525	90	748,66	745,87		190	706	102	65	18,5		60,00
TL192 14M 85	48085192	22	GG	192	4040	100	855,62	852,82		230	813	102	102			85,00



PULEGGE DENTATE A BUSSOLA CONICA PER CINGHIE HTD®

HTD® TIMING BELT PULLEYS FOR TAPER BUSHES

14M

PASSO 14 mm

PER CINGHIE LARGHEZZA 115 mm

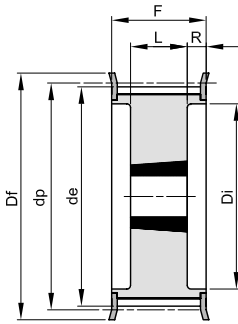

18F

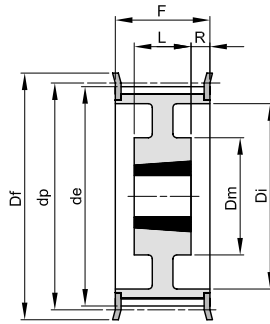

19F

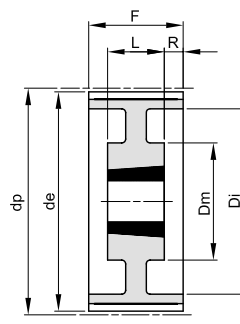

19

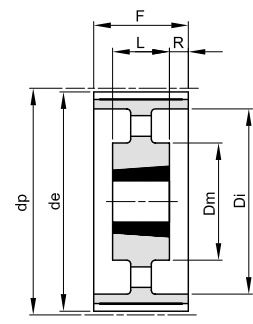

20

Materiale: Acciaio (St)
Materiale: Ghisa (GG)

descrizione	codice	tipo	materiale	denti	bussola	foro max	dp	de	Df	Dm	Di	F	L	R	n° flangia	Kg.
TL 28 14M 115	48115028	18F	St	28	2517	60	124,78	122,12	127		98	133	45	44	400	3,80
TL 30 14M 115	48115030	18F	St	30	2517	60	133,69	130,99	138		100	133	45	44	401	5,00
TL 32 14M 115	48115032	18F	St	32	2517	60	142,60	139,88	154		108	133	45	44	403	6,80
TL 34 14M 115	48115034	18F	St	34	2517	60	151,52	148,79	160		110	133	45	44	404	6,90
TL 36 14M 115	48115036	18F	St	36	3020	75	160,43	157,68	168		125	133	51	41	405	7,00
TL 38 14M 115	48115038	18F	St	38	3020	75	169,34	166,60	183		130	133	51	41	406	8,50
TL 40 14M 115	48115040	18F	St	40	3020	75	178,25	175,49	188		138	133	51	41	407	9,10
TL 44 14M 115	48115044	18F	St	44	3030	75	196,08	193,28	211		155	133	76	28,5	411	13,00
TL 48 14M 115	48115048	18F	St	48	3030	75	213,90	211,11	226		170	133	76	28,5	412	16,00
TL 56 14M 115	48115056	18F	GG	56	3535	90	249,55	246,76	256		210	133	89	22	416	24,00
TL 64 14M 115	48115064	19F	GG	64	3535	90	285,21	282,41	296	190	240	133	89	22	418	32,00
TL 72 14M 115	48115072	19	GG	72	3535	90	320,86	318,06		190	280	133	89	22		31,00
TL 80 14M 115	48115080	20	GG	80	3535	90	356,51	353,71		190	315	133	89	22		32,00
TL 90 14M 115	48115090	20	GG	90	3535	90	401,07	398,28		190	360	133	89	22		37,00
TL112 14M 115	48115112	20	GG	112	3535	90	499,11	496,32		190	457	133	89	22		45,00
TL144 14M 115	48115144	20	GG	144	4040	100	641,71	638,92		230	600	133	102	15,5		63,00
TL168 14M 115	48115168	20	GG	168	4040	100	748,66	745,87		230	706	133	102	15,5		77,50
TL192 14M 115	48115192	20	GG	192	4040	100	855,62	852,82		230	813	133	102	15,5		95,00



PULEGGE DENTATE A BUSSOLA CONICA PER CINGHIE HTD®

HTD® TIMING BELT PULLEYS FOR TAPER BUSHES

14M

PASSO 14 mm

PER CINGHIE LARGHEZZA 170 mm

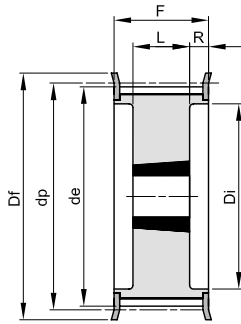

18F

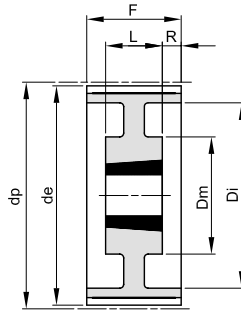

19

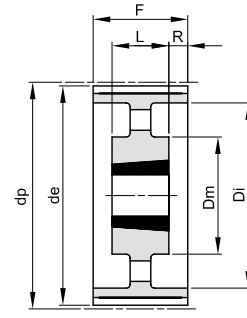

20

Materiale: Acciaio (St)
Materiale: Ghisa (GG)

descrizione	codice	tipo	materiale	denti	bussola	foro max	dp	de	Df	Dm	Di	F	L	R	n° flangia	Kg.
TL 38 14M 170	48170038	18F	St	38	3030	75	169,34	166,60	183		130	187	76	55,5	406	11,70
TL 40 14M 170	48170040	18F	St	40	3030	75	178,25	175,49	188		138	187	76	55,5	407	13,00
TL 44 14M 170	48170044	18F	St	44	3535	90	196,08	193,28	211		155	187	89	49	411	15,00
TL 48 14M 170	48170048	18F	St	48	3535	90	213,90	211,11	226		170	187	89	49	412	19,00
TL 56 14M 170	48170056	18F	St	56	3535	90	249,55	246,76	256		210	187	89	49	416	28,50
TL 64 14M 170	48170064	18F	GG	64	4040	100	285,21	282,41	296		240	187	102	42,5	418	41,00
TL 72 14M 170	48170072	19	GG	72	4040	100	320,86	318,06		230	280	187	102	42,5		47,00
TL 80 14M 170	48170080	19	GG	80	4040	100	356,51	353,71		230	315	187	102	42,5		48,00
TL 90 14M 170	48170090	20	GG	90	4040	100	401,07	398,28		230	360	187	102	42,5		52,50
TL112 14M 170	48170112	20	GG	112	5050	125	499,11	496,32		265	457	187	127	30		74,50
TL144 14M 170	48170144	20	GG	144	5050	125	641,71	638,92		265	600	187	127	30		91,00
TL168 14M 170	48170168	20	GG	168	5050	125	748,66	745,87		265	706	187	127	30		116,00
TL192 14M 170	48170192	20	GG	192	5050	125	855,62	852,82		265	813	187	127	30		134,00



PULEGGE DENTATE "PCB" A BUSSOLA CONICA PER CINGHIE SYNCHROCHAIN "PCB" SYNCHROCHAIN TIMING BELTS PULLEYS FOR TAPER BUSHES

8M

PASSO 8 mm

PER CINGHIE LARGHEZZA 12 mm

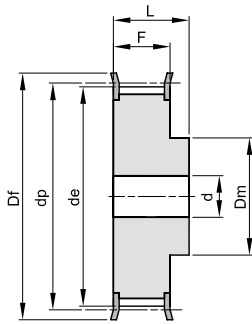

2F

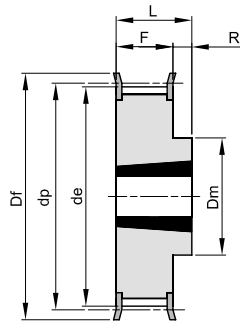

10F

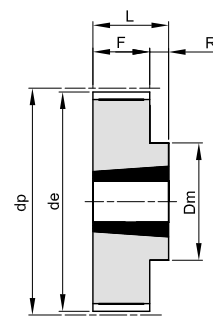

10

Materiale: Acciaio (St)
Materiale: Ghisa (GG)

descrizione	codice	tipo	materiale	denti	buss.	foro max	dp	de	Df	Dm	Di	F	L	R	d	n° flangia	Kg.
8M 22S 12	PCB47012022	2F	St	22			56,02	54,42	60	43		20	30	10	12	308	0,43
TL 8M 25S 12	PCB47012025	10F	St	25	1108	28	63,66	62,06	66	49		20	22	2		310	0,25
TL 8M 28S 12	PCB47012028	10F	St	28	1108	28	71,30	69,70	75	56		20	22	2		312	0,37
TL 8M 30S 12	PCB47012030	10F	St	30	1210	32	76,39	74,79	83	60		20	25	5		314	0,41
TL 8M 32S 12	PCB47012032	10F	St	32	1610	42	81,49	79,89	87	66		20	25	5		315	0,43
TL 8M 34S 12	PCB47012034	10F	St	34	1610	42	86,58	84,98	91	68		20	25	5		316	0,45
TL 8M 36S 12	PCB47012036	10F	St	36	1610	42	91,67	90,07	98	74		20	25	5		319	0,59
TL 8M 38S 12	PCB47012038	10F	St	38	1610	42	96,77	95,17	103	80		20	25	5		320	0,70
TL 8M 40S 12	PCB47012040	10F	St	40	1610	42	101,86	100,26	106	85		20	25	5		321	0,82
TL 8M 45S 12	PCB47012045	10F	St	45	2012	50	114,59	112,99	119	92		20	32	12		325	1,10
TL 8M 48S 12	PCB47012048	10F	St	48	2012	50	122,23	120,63	127	100		20	32	12		327	1,42
TL 8M 50S 12	PCB47012050	10F	St	50	2012	50	127,32	125,72	135	104		20	32	12		328	1,60
TL 8M 56S 12	PCB47012056	10F	St	56	2012	50	142,60	141,00	148	104		20	32	12		333	2,10
TL 8M 60S 12	PCB47012060	10F	St	60	2012	50	152,79	151,19	158	111		20	32	12		335	2,40
TL 8M 64S 12	PCB47012064	10F	St	64	2012	50	162,97	161,37	168	111		20	32	12		338	2,70
TL 8M 75S 12	PCB47012075	10	GG	75	2012	50	190,99	189,39		111		20	32	12			3,70
TL 8M 80S 12	PCB47012080	10	GG	80	2012	50	203,72	202,12		111		20	32	12			4,40
TL 8M 90S 12	PCB47012090	10	GG	90	2012	50	229,18	227,58		111		20	32	12			5,50



PULEGGE DENTATE "PCB" A BUSSOLA CONICA PER CINGHIE SYNCHROCHAIN "PCB" SYNCHROCHAIN TIMING BELTS PULLEYS FOR TAPER BUSHES

8M

PASSO 8 mm

PER CINGHIE LARGHEZZA 21 mm

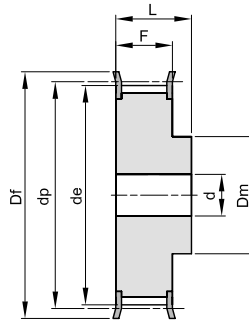

2F

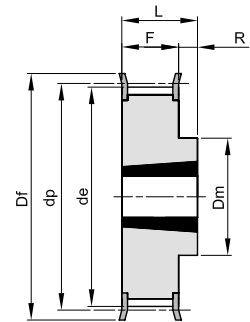

10F

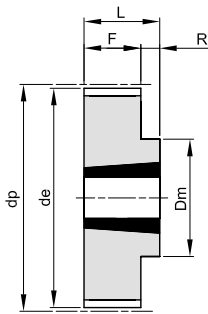

10

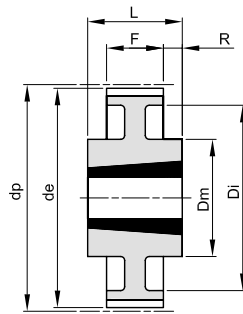

13

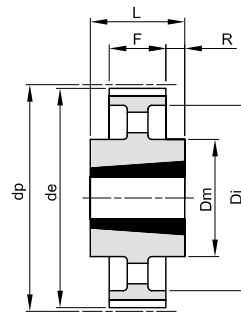

14

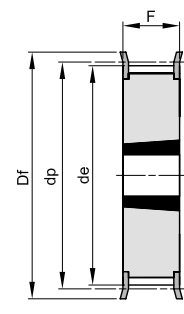

15F

Materiale: Acciaio (St)
Materiale: Ghisa (GG)

descrizione	codice	tipo	materiale	denti	buss.	foro max	dp	de	Df	Dm	Di	F	L	R	d	n° flangia	Kg.
8M 22S 21	PCB47021022	2F	St	22			56,02	54,42	60	43		30	40	10	12	308	0,56
TL 8M 25S 21	PCB47021025	15F	St	25	1108	28	63,66	62,06	66			30				310	0,36
TL 8M 28S 21	PCB47021028	15F	St	28	1210	32	71,30	69,70	75			30				312	0,41
TL 8M 30S 21	PCB47021030	15F	St	30	1210	32	76,39	74,79	83			30				314	0,56
TL 8M 32S 21	PCB47021032	15F	St	32	1610	42	81,49	79,89	87			30				315	0,52
TL 8M 34S 21	PCB47021034	15F	St	34	1610	42	86,58	84,98	91			30				316	0,61
TL 8M 36S 21	PCB47021036	15F	St	36	1610	42	91,67	90,07	98			30				319	0,70
TL 8M 38S 21	PCB47021038	15F	St	38	1610	42	96,77	95,17	103			30				320	0,92
TL 8M 40S 21	PCB47021040	15F	St	40	1610	42	101,86	100,26	106			30				321	1,06
TL 8M 45S 21	PCB47021045	10F	St	45	2012	50	114,59	112,99	119	92		30	32	2		325	1,30
TL 8M 48S 21	PCB47021048	10F	St	48	2012	50	122,23	120,63	127	100		30	32	2		327	1,60
TL 8M 50S 21	PCB47021050	10F	St	50	2012	50	127,32	125,72	135	104		30	32	2		328	1,83
TL 8M 56S 21	PCB47021056	10F	St	56	2012	50	142,60	141,00	148	111		30	32	2		333	2,40
TL 8M 60S 21	PCB47021060	10F	St	60	2517	65	152,79	151,19	158	124		30	45	15		335	3,20
TL 8M 64S 21	PCB47021064	10F	St	64	2517	65	162,97	161,37	168	124		30	45	15		338	3,80
TL 8M 75S 21	PCB47021075	10	GG	75	2517	65	190,99	189,39		124		30	45	15			6,20
TL 8M 80S 21	PCB47021080	10	GG	80	2517	65	203,72	202,12		124		30	45	15			6,00
TL 8M 90S 21	PCB47021090	13	GG	90	2517	65	229,18	227,58		124	198	30	45	7,5			5,40
TL 8M 112S 21	PCB47021112	13	GG	112	2517	65	285,21	283,61		124	253	30	45	7,5			7,40
TL 8M 140S 21	PCB47021140	14	GG	140	3020	75	356,51	354,91		150	324	30	51	10,5			9,00



PULEGGE DENTATE "PCB" A BUSSOLA CONICA PER CINGHIE SYNCHROCHAIN "PCB" SYNCHROCHAIN TIMING BELTS PULLEYS FOR TAPER BUSHES

8M

PASSO 8 mm

PER CINGHIE LARGHEZZA 36 mm

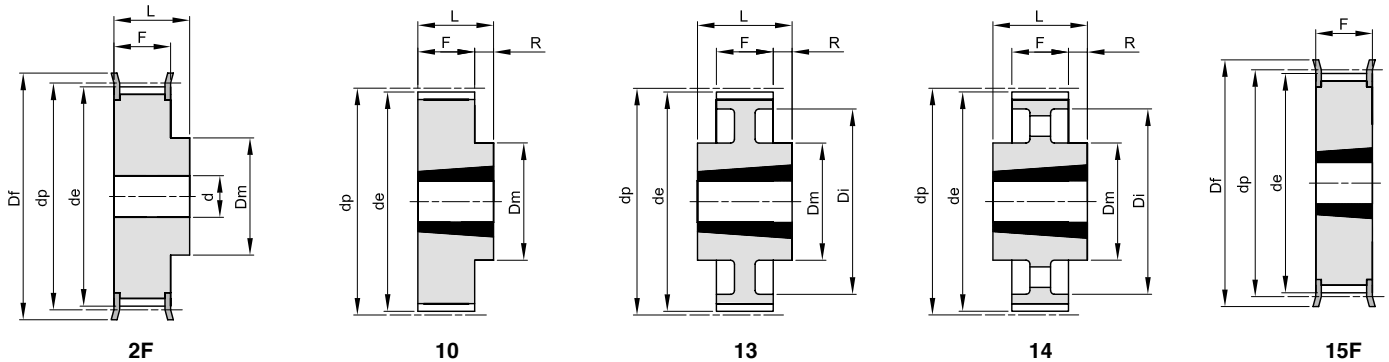

Materiale: Acciaio (St)
Materiale: Ghisa (GG)

descrizione	codice	tipo	materiale	denti	buss.	foro max	dp	de	Df	Dm	Di	F	L	R	d	n° flangia	Kg.
8M 25S 36	PCB47036025	2F	St	25			63,66	62,06	66	49		45	55		12	310	1,40
TL 8M 28S 36	PCB47036028	15F	St	28	1210	32	71,30	69,70	75			45				312	0,64
TL 8M 30S 36	PCB47036030	15F	St	30	1610	42	76,39	74,79	83			45				314	0,59
TL 8M 32S 36	PCB47036032	15F	St	32	1610	42	81,49	79,89	87			45				315	0,79
TL 8M 34S 36	PCB47036034	15F	St	34	1610	42	86,58	84,98	91			45				316	0,63
TL 8M 36S 36	PCB47036036	15F	St	36	1610	42	91,67	90,07	98			45				319	1,15
TL 8M 38S 36	PCB47036038	15F	St	38	1610	42	96,77	95,17	103			45				320	1,39
TL 8M 40S 36	PCB47036040	15F	St	40	2012	50	101,86	100,26	106			45				321	1,34
TL 8M 45S 36	PCB47036045	15F	St	45	2012	50	114,59	112,99	119			45				325	1,87
TL 8M 48S 36	PCB47036048	15F	St	48	2012	50	122,23	120,63	127			45				327	2,20
TL 8M 50S 36	PCB47036050	15F	St	50	2012	50	127,32	125,72	135			45				328	2,70
TL 8M 56S 36	PCB47036056	15F	St	56	2517	65	142,60	141,00	148			45				333	3,00
TL 8M 60S 36	PCB47036060	15F	St	60	2517	65	152,79	151,19	158			45				335	3,80
TL 8M 64S 36	PCB47036064	15F	St	64	2517	65	162,97	161,37	168			45				338	4,50
TL 8M 75S 36	PCB47036075	10	GG	75	3020	75	190,99	189,39		150		45	51	6			6,20
TL 8M 80S 36	PCB47036080	10	GG	80	3020	75	203,72	202,12		150		45	51	6			7,40
TL 8M 90S 36	PCB47036090	13	GG	90	3020	75	229,18	227,58		150	197	45	51	3			7,20
TL 8M 112S 36	PCB47036112	13	GG	112	3020	75	285,21	283,61		150	253	45	51	3			10,40
TL 8M 140S 36	PCB47036140	14	GG	140	3020	75	356,51	354,91		150	324	45	51	3			12,70
TL 8M 168S 36	PCB47036168	14	GG	168	3525	90	427,81	426,21		198	396	45	65	10			21,50
TL 8M 192S 36	PCB47036192	14	GG	192	3525	90	488,92	487,32		198	457	45	65	10			27,00



PULEGGE DENTATE "PCB" A BUSSOLA CONICA PER CINGHIE SYNCHROCHAIN "PCB" SYNCHROCHAIN TIMING BELTS PULLEYS FOR TAPER BUSHES

8M

PASSO 8 mm

PER CINGHIE LARGHEZZA 62 mm

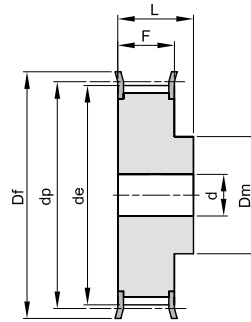

2F

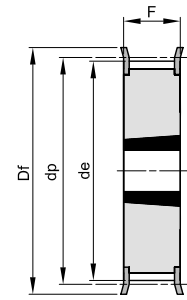

15F

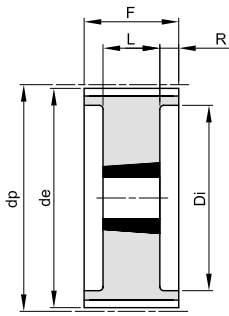

18

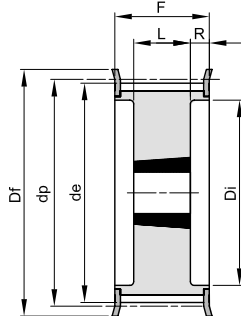

18F

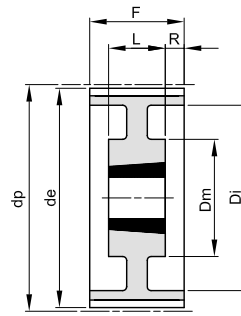

19

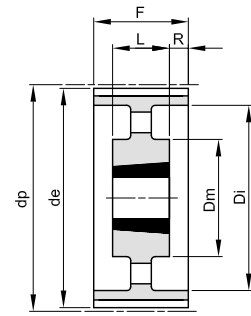

20

Materiale: Acciaio (St)
Materiale: Ghisa (GG)

descrizione	codice	tipo	materiale	denti	buss.	foro max	dp	de	Df	Dm	Di	F	L	R	d	n° flangia	Kg.
8M 30S 62	PCB47062030	2F	St	30			76,39	74,79	83	62		72	84	15	314	2,40	
8M 32S 62	PCB47062032	2F	St	32			81,49	79,89	87	65		72	84	15	315	2,80	
8M 34S 62	PCB47062034	2F	St	34			86,58	84,98	91	70		72	84	15	316	3,00	
8M 36S 62	PCB47062036	2F	St	36			91,67	90,07	98	75		72	84	15	319	3,40	
8M 38S 62	PCB47062038	2F	St	38			96,77	95,17	103	75		72	84	15	320	3,80	
TL 8M 40S 62	PCB47062040	15F	St	40	2012	50	101,86	100,26	106			72				321	2,06
TL 8M 45S 62	PCB47062045	15F	St	45	2012	50	114,59	112,99	119			72				325	3,00
TL 8M 48S 62	PCB47062048	15F	St	48	2517	65	122,23	120,63	127			72				327	2,90
TL 8M 50S 62	PCB47062050	15F	St	50	2517	65	127,32	125,72	135			72				328	3,25
TL 8M 56S 62	PCB47062056	18F	St	56	2517	65	142,60	141,00	148		111	72	45	13,5		333	3,90
TL 8M 60S 62	PCB47062060	18F	St	60	2517	65	152,79	151,19	158		121	72	45	13,5		335	4,70
TL 8M 64S 62	PCB47062064	18F	St	64	2517	65	162,97	161,37	168		131	72	45	13,5		338	5,60
TL 8M 75S 62	PCB47062075	18	GG	75	3020	75	190,99	189,39			159	72	51	10,5			7,50
TL 8M 80S 62	PCB47062080	18	GG	80	3020	75	203,72	202,12			172	72	51	10,5			9,20
TL 8M 90S 62	PCB47062090	18	GG	90	3020	75	229,18	227,58			197	72	51	10,5			7,70
TL 8M 112S 62	PCB47062112	19	GG	112	3020	75	285,21	283,61		150	253	72	51	10,5			12,10
TL 8M 140S 62	PCB47062140	19	GG	140	3525	90	356,51	354,91		198	324	72	65	3,5			22,70
TL 8M 168S 62	PCB47062168	20	GG	168	3525	90	427,81	426,21		198	396	72	65	3,5			26,80
TL 8M 192S 62	PCB47062192	20	GG	192	3525	90	488,92	487,32		198	457	72	65	3,5			34,20



PULEGGE DENTATE "PCB" A BUSSOLA CONICA PER CINGHIE SYNCHROCHAIN "PCB" SYNCHROCHAIN TIMING BELTS PULLEYS FOR TAPER BUSHES

14M

PASSO 14 mm

PER CINGHIE LARGHEZZA 20 mm

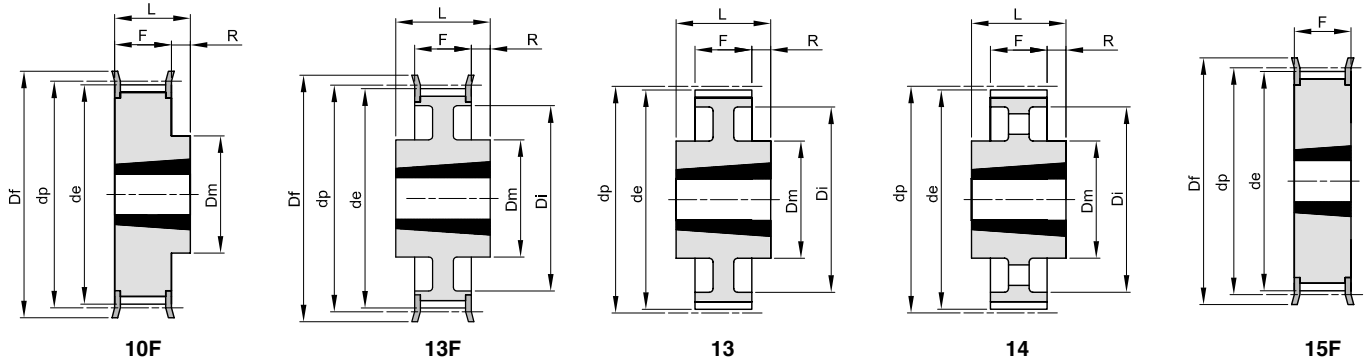

Materiale: Acciaio (St)
Materiale: Ghisa (GG)

descrizione	codice	tipo	materiale	denti	buss.	foro max	dp	de	Df	Dm	Di	F	L	R	d	n° flangia	Kg.
TL 14M 28S 20	PCB48020028	15F	St	28	2012	50	124,78	121,98	127			33				400	1,66
TL 14M 30S 20	PCB48020030	15F	St	30	2012	50	133,69	130,89	138			33				401	2,20
TL 14M 32S 20	PCB48020032	15F	St	32	2012	50	142,60	139,80	154			33				403	3,20
TL 14M 34S 20	PCB48020034	10F	St	34	2517	65	151,52	148,72	160	117		33	45	12		404	3,00
TL 14M 36S 20	PCB48020036	10F	St	36	2517	65	160,43	157,63	168	117		33	45	12		405	3,60
TL 14M 38S 20	PCB48020038	10F	St	38	2517	65	169,34	166,54	183	117		33	45	12		406	4,00
TL 14M 40S 20	PCB48020040	10F	St	40	2517	65	178,25	175,45	188	117		33	45	12		407	4,70
TL 14M 44S 20	PCB48020044	10F	St	44	3020	75	196,08	193,28	211	144		33	51	18		411	5,60
TL 14M 48S 20	PCB48020048	10F	St	48	3020	75	213,90	211,11	226	144		33	51	18		412	6,80
TL 14M 50S 20	PCB48020050	10F	GG	50	3020	75	222,82	220,02	240	144		33	51	18		414	7,70
TL 14M 56S 20	PCB48020056	13F	GG	56	3020	75	249,55	246,76	256	144	207	33	51	9		416	7,70
TL 14M 60S 20	PCB48020060	13	GG	60	3020	75	267,38	264,58		159	224	33	51	9			8,50
TL 14M 64S 20	PCB48020064	13	GG	64	3020	75	285,21	282,41		159	242	33	51	9			10,20
TL 14M 72S 20	PCB48020072	13	GG	72	3020	75	320,86	318,06		159	278	33	51	9			11,50
TL 14M 80S 20	PCB48020080	13	GG	80	3020	75	356,51	353,71		159	314	33	51	9			13,50
TL 14M 90S 20	PCB48020090	14	GG	90	3020	75	401,07	398,27		159	360	33	51	9			14,20
TL 14M 112S 20	PCB48020112	14	GG	112	3020	75	499,11	496,31		159	456	33	51	9			18,10
TL 14M 140S 20	PCB48020140	14	GG	140	3020	75	623,89	621,09		159	581	33	51	9			22,90



PULEGGE DENTATE "PCB" A BUSSOLA CONICA PER CINGHIE SYNCHROCHAIN "PCB" SYNCHROCHAIN TIMING BELTS PULLEYS FOR TAPER BUSHES

14M

PASSO 14 mm

PER CINGHIE LARGHEZZA 37 mm

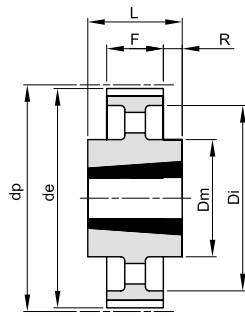

14

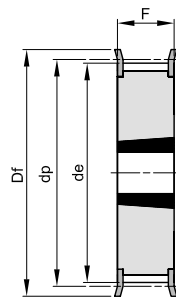

15F

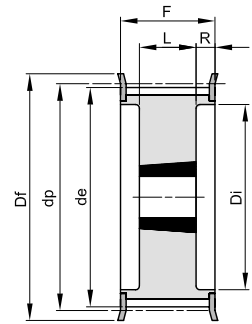

18F

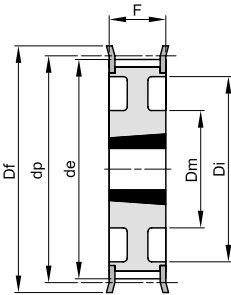

21F

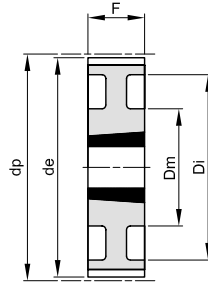

21

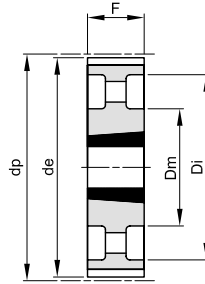

22

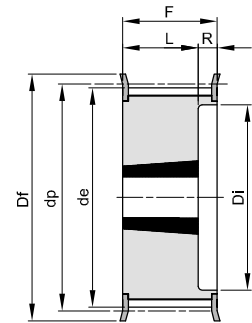

23F

Materiale: Acciaio (St)
Materiale: Ghisa (GG)

descrizione	codice	tipo	materiale	denti	buss.	foro max	dp	de	Df	Dm	Di	F	L	R	d	n° flangia	Kg.
TL 14M 28S 37	PCB48037028	23F	St	28	2012	50	124,78	121,98	127		88	51	32	19		400	2,20
TL 14M 30S 37	PCB48037030	18F	St	30	2517	65	133,69	130,89	138		98	51	45	3		401	2,50
TL 14M 32S 37	PCB48037032	18F	St	32	2517	65	142,60	139,80	154		100	51	45	3		403	3,00
TL 14M 34S 37	PCB48037034	18F	St	34	2517	65	151,52	148,72	160		109	51	45	3		404	3,80
TL 14M 36S 37	PCB48037036	23F	St	36	2517	65	160,43	157,63	168		117	51	45	6		405	4,30
TL 14M 38S 37	PCB48037038	23F	St	38	2517	65	169,34	166,54	183		126	51	45	6		406	5,10
TL 14M 40S 37	PCB48037040	23F	St	40	2517	65	178,25	175,45	188		135	51	45	6		407	6,00
TL 14M 44S 37	PCB48037044	15F	St	44	3020	75	196,08	193,28	211			51				411	7,00
TL 14M 48S 37	PCB48037048	15F	St	48	3020	75	213,90	211,11	226			51				412	9,00
TL 14M 50S 37	PCB48037050	15F	GG	50	3020	75	222,82	220,02	240			51				414	10,00
TL 14M 56S 37	PCB48037056	21F	GG	56	3020	75	249,55	246,76	256	144	207	51				416	9,20
TL 14M 60S 37	PCB48037060	21	GG	60	3020	75	267,38	264,58		159	224	51					10,20
TL 14M 64S 37	PCB48037064	21	GG	64	3020	75	285,21	282,41		159	242	51					12,20
TL 14M 72S 37	PCB48037072	21	GG	72	3020	75	320,86	318,06		159	278	51					13,40
TL 14M 80S 37	PCB48037080	21	GG	80	3020	75	356,51	353,71		159	314	51					16,10
TL 14M 90S 37	PCB48037090	22	GG	90	3020	75	401,07	398,27		159	360	51					17,20
TL 14M 112S 37	PCB48037112	22	GG	112	3020	75	499,11	496,31		159	456	51					23,00
TL 14M 140S 37	PCB48037140	14	GG	140	3525	90	623,89	621,09		206	581	51	65	7			41,00
TL 14M 168S 37	PCB48037168	14	GG	168	3525	90	748,66	745,87		206	706	51	65	7			51,50
TL 14M 192S 37	PCB48037192	14	GG	192	4030	90	855,61	852,82		215	812	51	76	12,5			60,00



PULEGGE DENTATE "PCB" A BUSSOLA CONICA PER CINGHIE SYNCHROCHAIN "PCB" SYNCHROCHAIN TIMING BELTS PULLEYS FOR TAPER BUSHES

14M

PASSO 14 mm

PER CINGHIE LARGHEZZA 68 mm

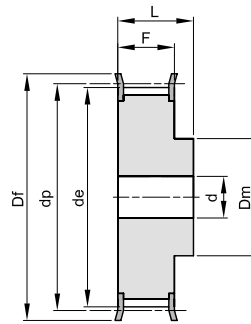

2F

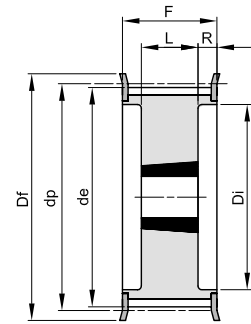

18F

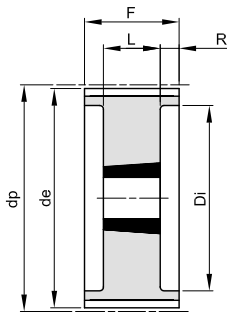

18

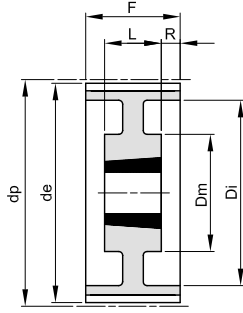

19

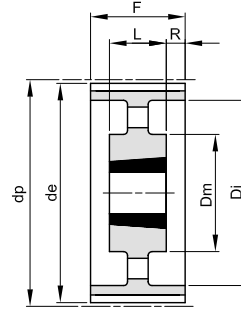

20

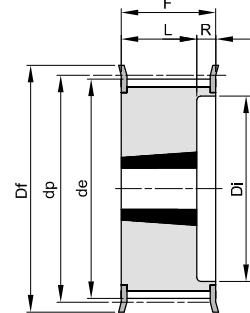

23F

Materiale: Acciaio (St)
Materiale: Ghisa (GG)

descrizione	codice	tipo	materiale	denti	buss.	foro max	dp	de	Df	Dm	Di	F	L	R	d	n° flangia	Kg.
14M 34S 68	PCB48068034	2F	St	34			151,52	148,72	160	131		84	104	32	404	10,50	
14M 36S 68	PCB48068036	2F	St	36			160,43	157,63	168	131		84	104	32	405	11,70	
14M 38S 68	PCB48068038	2F	St	38			169,34	166,54	183	141		84	104	32	406	13,40	
14M 40S 68	PCB48068040	2F	St	40			178,25	175,45	188	155		84	104	32	407	15,40	
TL 14M 44S 68	PCB48068044	18F	St	44	3020	75	196,08	193,28	211		153	84	51	16,5		411	9,20
TL 14M 48S 68	PCB48068048	23F	St	48	3020	75	213,90	211,11	226		171	84	51	33		412	11,30
TL 14M 50S 68	PCB48068050	18F	GG	50	3525	90	222,82	220,02	240		180	84	65	9,5		414	15,50
TL 14M 56S 68	PCB48068056	18F	GG	56	3525	90	249,55	246,76	256		207	84	65	9,5		416	16,80
TL 14M 60S 68	PCB48068060	18	GG	60	3525	90	267,38	264,58			224	84	65	9,5			20,40
TL 14M 64S 68	PCB48068064	18	GG	64	3525	90	285,21	282,41			242	84	65	9,5			23,60
TL 14M 72S 68	PCB48068072	19	GG	72	3525	90	320,86	318,06		178	278	84	65	9,5			20,30
TL 14M 80S 68	PCB48068080	20	GG	80	3525	90	356,51	353,71		178	314	84	65	9,5			21,30
TL 14M 90S 68	PCB48068090	20	GG	90	3525	90	401,07	398,27		178	360	84	65	9,5			24,40
TL 14M 112S 68	PCB48068112	20	GG	112	3525	90	499,11	496,31		178	456	84	65	9,5			32,70
TL 14M 140S 68	PCB48068140	20	GG	140	3525	90	623,89	621,09		206	581	84	65	9,5			55,00
TL 14M 168S 68	PCB48068168	20	GG	168	3525	90	748,66	745,87		206	706	84	65	9,5			71,00
TL 14M 192S 68	PCB48068192	20	GG	192	4030	90	855,61	852,82		215	812	84	76	4			80,50



PULEGGE DENTATE "PCB" A BUSSOLA CONICA PER CINGHIE SYNCHROCHAIN "PCB" SYNCHROCHAIN TIMING BELTS PULLEYS FOR TAPER BUSHES

14M

PASSO 14 mm

PER CINGHIE LARGHEZZA 90 mm

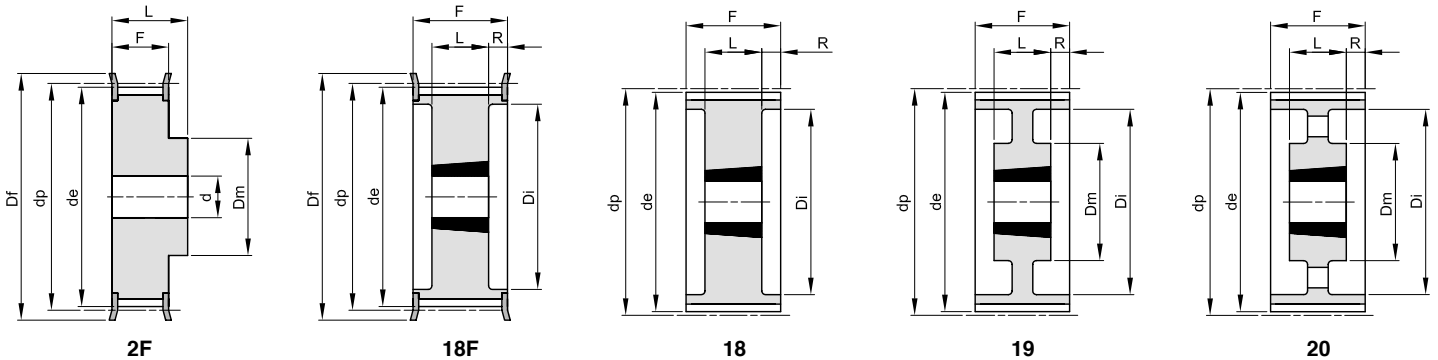

Materiale: Acciaio (St)
Materiale: Ghisa (GG)

descrizione	codice	tipo	materiale	denti	buss.	foro max	dp	de	Df	Dm	Di	F	L	R	d	n° flangia	Kg.
14M 36S 90	PCB48090036	2F	St	36			160,43	157,63	168	131		106	136		32	405	14,5
14M 38S 90	PCB48090038	2F	St	38			169,34	166,54	183	141		106	136		32	406	17,5
14M 40S 90	PCB48090040	2F	St	40			178,25	175,45	188	155		106	136		32	407	19,1
14M 44S 90	PCB48090044	2F	St	44			196,08	193,28	211	167		106	136		32	411	23,9
TL 14M 48S 90	PCB48090048	18F	St	48	3525	90	213,90	211,11	226		171	106	66	20		412	12,7
TL 14M 50S 90	PCB48090050	18F	GG	50	3525	90	222,82	220,02	240		180	106	66	20		414	14,5
TL 14M 56S 90	PCB48090056	18F	GG	56	3525	90	249,55	246,76	256		207	106	66	20		416	19,0
TL 14M 60S 90	PCB48090060	18	GG	60	3525	90	267,38	264,58			224	106	66	20			22,5
TL 14M 64S 90	PCB48090064	18	GG	64	3525	90	285,21	282,41			242	106	66	20			24,0
TL 14M 72S 90	PCB48090072	19	GG	72	3525	90	320,86	318,06		178	278	106	66	20			22,6
TL 14M 80S 90	PCB48090080	19	GG	80	4030	90	356,51	353,71		215	314	106	76	15			27,0
TL 14M 90S 90	PCB48090090	19	GG	90	4030	90	401,07	398,27		215	360	106	76	15			34,1
TL 14M 112S 90	PCB48090112	20	GG	112	4535	120	499,11	496,31		215	456	106	90	8			46,0
TL 14M 140S 90	PCB48090140	20	GG	140	4535	120	623,89	621,09		215	581	106	90	8			61,0
TL 14M 168S 90	PCB48090168	20	GG	168	5040	125	748,66	745,87		267	706	106	102	2			90,0
TL 14M 192S 90	PCB48090192	20	GG	192	5040	125	855,61	852,82		267	812	106	102	2			108,5



PULEGGE DENTATE "PCB" A BUSSOLA CONICA PER CINGHIE SYNCHROCHAIN "PCB" SYNCHROCHAIN TIMING BELTS PULLEYS FOR TAPER BUSHES

14M

PASSO 14 mm

PER CINGHIE LARGHEZZA 125 mm

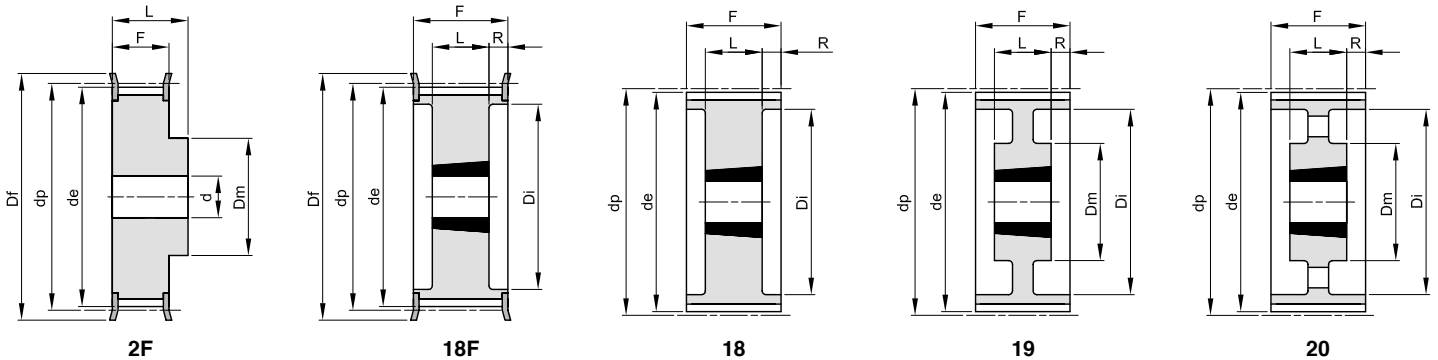

Materiale: Acciaio (St)
Materiale: Ghisa (GG)

descrizione	codice	tipo	materiale	denti	buss.	foro max	dp	de	Df	Dm	Di	F	L	R	d	n° flangia	Kg.
14M 38S 125	PCB48125038	2F	St	38			169,34	166,54	183	141	141	161	32	406	20,3		
14M 40S 125	PCB48125040	2F	St	40			178,25	175,45	188	155	141	161	32	407	23,0		
14M 44S 125	PCB48125044	2F	St	44			196,08	193,28	211	167	141	161	32	411	28,8		
14M 48S 125	PCB48125048	2F	St	48			213,90	211,11	226	185	141	161	32	412	34,6		
TL 14M 50S 125	PCB48125050	18F	GG	50	3525	90	222,82	220,02	240		180	141	65	38	414	16,8	
TL 14M 56S 125	PCB48125056	18F	GG	56	3525	90	249,55	246,76	256		207	141	65	38	416	21,6	
TL 14M 60S 125	PCB48125060	18	GG	60	4030	90	267,38	264,58			224	141	76	32,5		25,6	
TL 14M 64S 125	PCB48125064	18	GG	64	4030	90	285,21	282,41			242	141	76	32,5		29,7	
TL 14M 72S 125	PCB48125072	19	GG	72	4030	90	320,86	318,06		215	278	141	76	32,5		30,0	
TL 14M 80S 125	PCB48125080	19	GG	80	4030	90	356,51	353,71		215	314	141	76	32,5		33,4	
TL 14M 90S 125	PCB48125090	19	GG	90	4030	90	401,07	398,27		215	360	141	76	32,5		39,4	
TL 14M 112S 125	PCB48125112	20	GG	112	4535	120	499,11	496,31		215	456	141	89	26		56,0	
TL 14M 140S 125	PCB48125140	20	GG	140	4535	120	623,89	621,09		215	581	141	89	26		73,0	
TL 14M 168S 125	PCB48125168	20	GG	168	5040	125	748,66	745,87		267	706	141	102	19,5		101,0	
TL 14M 192S 125	PCB48125192	20	GG	192	5040	125	855,61	852,82		267	802	141	102	19,5		121,5	



PULEGGE DENTATE PASSO METRICO SERIE "T" - DIN 7721-2

METRIC PULLEYS "T" - DIN 7721-2

T 2,5

PASSO 2,5 mm

PER CINGHIE LARGHEZZA 6 mm

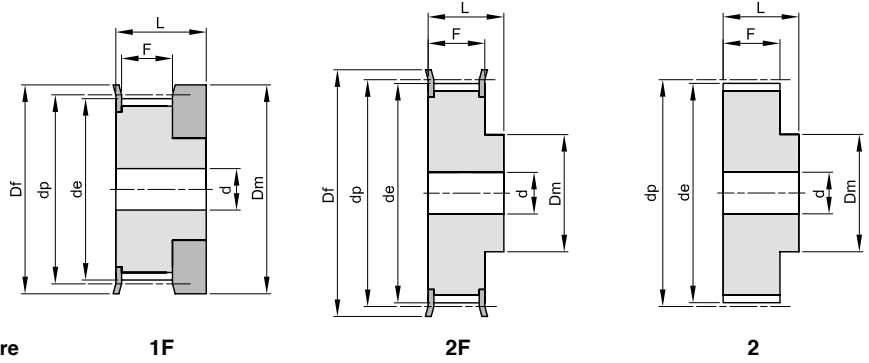

Materiale: Alluminio UNI 9006 - T6 (Al)
adatto per l'ossidazione dura a spessore

descrizione	codice	tipo	materiale	denti	de	Df	Dm	F	L	d	n° flangia	Kg.
16 T 2,5 12	26006012	1F	Al	12	9,00	13	12	9	16		100	0,01
16 T 2,5 14	26006014	1F	Al	14	10,60	15	14	9	16		101	0,01
16 T 2,5 15	26006015	1F	Al	15	11,40	15	15	9	16		101	0,01
16 T 2,5 16	26006016	1F	Al	16	12,20	16	16	9	16		102	0,01
16 T 2,5 18	26006018	2F	Al	18	13,80	18	10	10	16		104	0,01
16 T 2,5 19	26006019	2F	Al	19	14,60	18	10	10	16		104	0,01
16 T 2,5 20	26006020	2F	Al	20	15,40	19,5	11	10	16		105	0,01
16 T 2,5 22	26006022	2F	Al	22	17,00	23	11	10	16		106	0,01
16 T 2,5 24	26006024	2F	Al	24	18,55	23	12	10	16		107	0,01
16 T 2,5 25	26006025	2F	Al	25	19,35	23	13	10	16		107	0,01
16 T 2,5 26	26006026	2F	Al	26	20,15	25	14	10	16		108	0,01
16 T 2,5 28	26006028	2F	Al	28	21,75	25	14	10	16		108	0,02
16 T 2,5 30	26006030	2F	Al	30	23,35	28	16	10	16	6	109	0,02
16 T 2,5 32	26006032	2F	Al	32	24,95	32	16	10	16	6	110	0,02
16 T 2,5 36	26006036	2F	Al	36	28,10	36	20	10	16	6	111	0,03
16 T 2,5 40	26006040	2F	Al	40	31,30	38	22	10	16	6	112	0,03
16 T 2,5 44	26006044	2	Al	44	34,50		24	10	16	6		0,04
16 T 2,5 48	26006048	2	Al	48	37,70		26	10	16	6		0,05
16 T 2,5 60	26006060	2	Al	60	47,25		34	10	16	8		0,07



PULEGGE DENTATE PASSO METRICO SERIE "T" - DIN 7721-2

METRIC PULLEYS "T" - DIN 7721-2

T 5

PASSO 5 mm

PER CINGHIE LARGHEZZA 10 mm

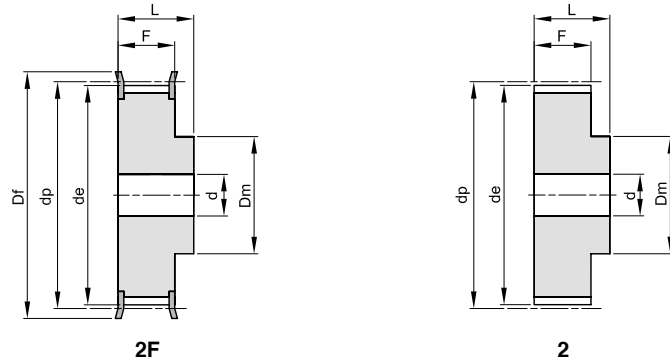

Materiale: Alluminio UNI 9006 - T6 (Al)
adatto per l'ossidazione dura a spessore

descrizione	codice	tipo	materiale	denti	de	Df	Dm	F	L	d	n° flangia	Kg.
21 T 5 10	27010010	2F	Al	10	15,05	19,5	8	15	21		200	0,01
21 T 5 12	27010012	2F	Al	12	18,25	23	10	15	21		201	0,01
21 T 5 14	27010014	2F	Al	14	21,45	25	13	15	21		203	0,02
21 T 5 15	27010015	2F	Al	15	23,05	28	16	15	21		204	0,02
21 T 5 16	27010016	2F	Al	16	24,60	32	18	15	21		205	0,03
21 T 5 18	27010018	2F	Al	18	27,80	32	20	15	21		205	0,03
21 T 5 19	27010019	2F	Al	19	29,40	36	22	15	21		206	0,04
21 T 5 20	27010020	2F	Al	20	31,00	36	23	15	21		206	0,04
21 T 5 22	27010022	2F	Al	22	34,25	38	24	15	21		207	0,05
21 T 5 24	27010024	2F	Al	24	37,40	42	26	15	21		208	0,06
21 T 5 25	27010025	2F	Al	25	38,95	44	26	15	21		209	0,06
21 T 5 26	27010026	2F	Al	26	40,60	44	26	15	21		209	0,06
21 T 5 27	27010027	2F	Al	27	42,20	48	30	15	21	8	210	0,07
21 T 5 28	27010028	2F	Al	28	43,75	48	32	15	21	8	210	0,07
21 T 5 30	27010030	2F	Al	30	46,95	51	34	15	21	8	211	0,07
21 T 5 32	27010032	2F	Al	32	50,10	54	38	15	21	8	212	0,09
21 T 5 36	27010036	2F	Al	36	56,45	63	38	15	21	8	215	0,11
21 T 5 40	27010040	2F	Al	40	62,85	66	40	15	21	8	216	0,14
21 T 5 42	27010042	2F	Al	42	66,00	71	40	15	21	8	217	0,18
21 T 5 44	27010044	2	Al	44	69,20		45	15	21	8		0,18
21 T 5 48	27010048	2	Al	48	75,55		50	15	21	8		0,20
21 T 5 60	27010060	2	Al	60	94,65		65	15	21	8		0,31



PULEGGE DENTATE PASSO METRICO SERIE "T" - DIN 7721-2

METRIC PULLEYS "T" - DIN 7721-2

T 5

PASSO 5 mm

PER CINGHIE LARGHEZZA 16 mm

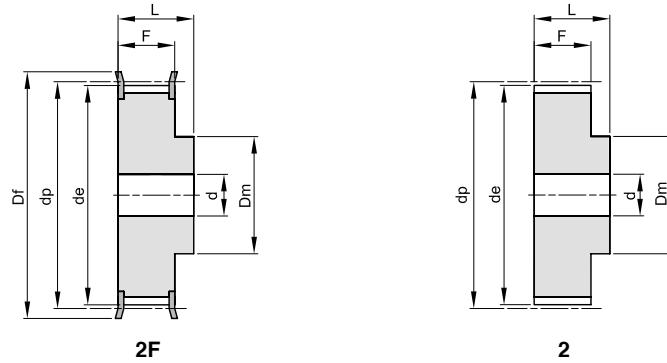

Materiale: Alluminio UNI 9006 - T6 (Al)
adatto per l'ossidazione dura a spessore

descrizione	codice	tipo	materiale	denti	de	Df	Dm	F	L	d	n° flangia	Kg.
27 T 5 10	27016010	2F	Al	10	15,05	19,5	8	21	27		200	0,02
27 T 5 12	27016012	2F	Al	12	18,25	23	10	21	27		201	0,02
27 T 5 14	27016014	2F	Al	14	21,45	25	13	21	27		203	0,03
27 T 5 15	27016015	2F	Al	15	23,05	28	16	21	27		204	0,03
27 T 5 16	27016016	2F	Al	16	24,60	32	18	21	27		205	0,04
27 T 5 18	27016018	2F	Al	18	27,80	32	20	21	27		205	0,04
27 T 5 19	27016019	2F	Al	19	29,40	36	22	21	27		206	0,05
27 T 5 20	27016020	2F	Al	20	31,00	36	23	21	27		206	0,06
27 T 5 22	27016022	2F	Al	22	34,25	38	24	21	27		207	0,06
27 T 5 24	27016024	2F	Al	24	37,40	42	26	21	27		208	0,08
27 T 5 25	27016025	2F	Al	25	38,95	44	26	21	27		209	0,08
27 T 5 26	27016026	2F	Al	26	40,60	44	26	21	27		209	0,09
27 T 5 27	27016027	2F	Al	27	42,20	48	30	21	27	8	210	0,09
27 T 5 28	27016028	2F	Al	28	43,75	48	32	21	27	8	210	0,09
27 T 5 30	27016030	2F	Al	30	46,95	51	34	21	27	8	211	0,10
27 T 5 32	27016032	2F	Al	32	50,10	54	38	21	27	8	212	0,12
27 T 5 36	27016036	2F	Al	36	56,45	63	38	21	27	8	215	0,16
27 T 5 40	27016040	2F	Al	40	62,85	66	40	21	27	8	216	0,19
27 T 5 42	27016042	2F	Al	42	66,00	71	40	21	27	8	217	0,20
27 T 5 44	27016044	2	Al	44	69,20		45	21	27	8		0,23
27 T 5 48	27016048	2	Al	48	75,55		50	21	27	8		0,28
27 T 5 60	27016060	2	Al	60	94,65		65	21	27	8		0,43



PULEGGE DENTATE PASSO METRICO SERIE "T" - DIN 7721-2

METRIC PULLEYS "T" - DIN 7721-2

T 5

PASSO 5 mm

PER CINGHIE LARGHEZZA 25 mm

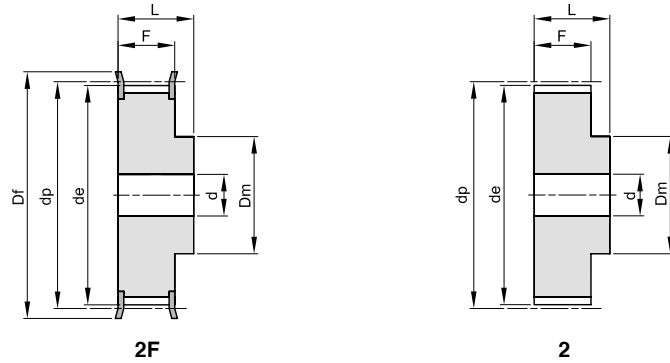

Materiale: Alluminio UNI 9006 - T6 (Al)
adatto per l'ossidazione dura a spessore

descrizione	codice	tipo	materiale	denti	de	Df	Dm	F	L	d	n° flangia	Kg.
36 T 5 10	27025010	2F	Al	10	15,05	19,5	8	30	36		200	0,02
36 T 5 12	27025012	2F	Al	12	18,25	23	10	30	36		201	0,03
36 T 5 14	27025014	2F	Al	14	21,45	25	13	30	36		203	0,04
36 T 5 15	27025015	2F	Al	15	23,05	28	16	30	36		204	0,04
36 T 5 16	27025016	2F	Al	16	24,60	32	18	30	36		205	0,05
36 T 5 18	27025018	2F	Al	18	27,80	32	20	30	36		205	0,06
36 T 5 19	27025019	2F	Al	19	29,40	36	22	30	36		206	0,07
36 T 5 20	27025020	2F	Al	20	31,00	36	23	30	36		206	0,08
36 T 5 22	27025022	2F	Al	22	34,25	38	24	30	36		207	0,08
36 T 5 24	27025024	2F	Al	24	37,40	42	26	30	36		208	0,11
36 T 5 25	27025025	2F	Al	25	38,95	44	26	30	36		209	0,12
36 T 5 26	27025026	2F	Al	26	40,60	44	26	30	36		209	0,12
36 T 5 27	27025027	2F	Al	27	42,20	48	30	30	36	8	210	0,13
36 T 5 28	27025028	2F	Al	28	43,75	48	32	30	36	8	210	0,14
36 T 5 30	27025030	2F	Al	30	46,95	51	34	30	36	8	211	0,15
36 T 5 32	27025032	2F	Al	32	50,10	54	38	30	36	8	212	0,18
36 T 5 36	27025036	2F	Al	36	56,45	63	38	30	36	8	215	0,23
36 T 5 40	27025040	2F	Al	40	62,85	66	40	30	36	8	216	0,28
36 T 5 42	27025042	2F	Al	42	66,00	71	40	30	36	8	217	0,29
36 T 5 44	27025044	2	Al	44	69,20		45	30	36	8		0,31
36 T 5 48	27025048	2	Al	48	75,55		50	30	36	8		0,40
36 T 5 60	27025060	2	Al	60	94,65		65	30	36	8		0,61



PULEGGE DENTATE PASSO METRICO SERIE "T" - DIN 7721-2

METRIC PULLEYS "T" - DIN 7721-2

T 10

PASSO 10 mm

PER CINGHIE LARGHEZZA 16 mm

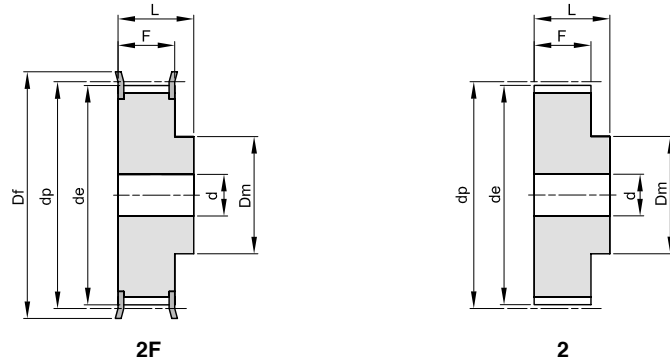

Materiale: Alluminio UNI 9006 - T6 (Al)
adatto per l'ossidazione dura a spessore

descrizione	codice	tipo	materiale	denti	de	Df	Dm	F	L	d	n° flangia	Kg.
31 T 10 12	28016012	2F	Al	12	36,35	42	28	21	31	6	208	0,08
31 T 10 14	28016014	2F	Al	14	42,70	48	32	21	31	8	210	0,10
31 T 10 15	28016015	2F	Al	15	45,90	51	32	21	31	8	211	0,12
31 T 10 16	28016016	2F	Al	16	49,10	54	35	21	31	8	212	0,13
31 T 10 18	28016018	2F	Al	18	55,45	60	40	21	31	8	214	0,17
31 T 10 19	28016019	2F	Al	19	58,65	66	44	21	31	8	216	0,18
31 T 10 20	28016020	2F	Al	20	61,80	66	46	21	31	8	216	0,21
31 T 10 22	28016022	2F	Al	22	68,20	75	52	21	31	8	218	0,25
31 T 10 24	28016024	2F	Al	24	74,55	83	58	21	31	8	219	0,29
31 T 10 25	28016025	2F	Al	25	77,75	83	60	21	31	8	219	0,31
31 T 10 26	28016026	2F	Al	26	80,90	87	60	21	31	8	220	0,36
31 T 10 27	28016027	2F	Al	27	84,10	91	60	21	31	8	221	0,37
31 T 10 28	28016028	2F	Al	28	87,25	93	60	21	31	8	222	0,40
31 T 10 30	28016030	2F	Al	30	93,65	97	60	21	31	8	223	0,44
31 T 10 32	28016032	2F	Al	32	100,00	106	65	21	31	10	224	0,49
31 T 10 36	28016036	2F	Al	36	112,75	119	70	21	31	10	225	0,62
31 T 10 40	28016040	2F	Al	40	125,45	131	80	21	31	10	226	0,77
31 T 10 44	28016044	2	Al	44	138,20		88	21	31	10		1,00
31 T 10 48	28016048	2	Al	48	150,95		95	21	31	16		1,10
31 T 10 60	28016060	2	Al	60	189,15		110	21	31	16		1,70



PULEGGE DENTATE PASSO METRICO SERIE "T" - DIN 7721-2

METRIC PULLEYS "T" - DIN 7721-2

T 10

PASSO 10 mm

PER CINGHIE LARGHEZZA 25 mm

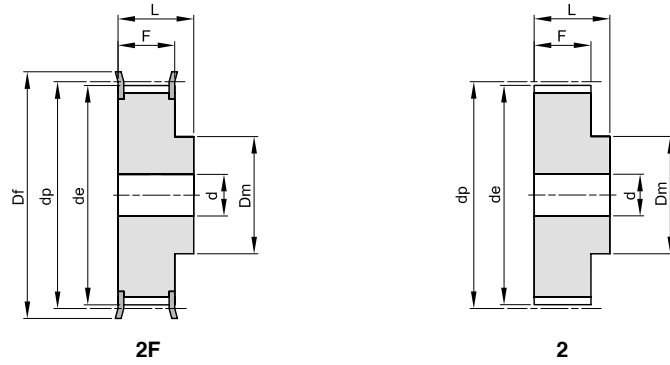

Materiale: Alluminio UNI 9006 - T6 (Al)
adatto per l'ossidazione dura a spessore

descrizione	codice	tipo	materiale	denti	de	Df	Dm	F	L	d	n° flangia	Kg.
40 T 10 12	28025012	2F	Al	12	36,35	42	28	30	40	6	208	0,10
40 T 10 14	28025014	2F	Al	14	42,70	48	32	30	40	8	210	0,13
40 T 10 15	28025015	2F	Al	15	45,90	51	32	30	40	8	211	0,15
40 T 10 16	28025016	2F	Al	16	49,10	54	35	30	40	8	212	0,18
40 T 10 18	28025018	2F	Al	18	55,45	60	40	30	40	8	214	0,22
40 T 10 19	28025019	2F	Al	19	58,65	66	44	30	40	8	216	0,25
40 T 10 20	28025020	2F	Al	20	61,80	66	46	30	40	8	216	0,28
40 T 10 22	28025022	2F	Al	22	68,20	75	52	30	40	8	218	0,34
40 T 10 24	28025024	2F	Al	24	74,55	83	58	30	40	8	219	0,39
40 T 10 25	28025025	2F	Al	25	77,75	83	60	30	40	8	219	0,42
40 T 10 26	28025026	2F	Al	26	80,90	87	60	30	40	8	220	0,48
40 T 10 27	28025027	2F	Al	27	84,10	91	60	30	40	8	221	0,54
40 T 10 28	28025028	2F	Al	28	87,25	93	60	30	40	8	222	0,55
40 T 10 30	28025030	2F	Al	30	93,65	97	60	30	40	8	223	0,64
40 T 10 32	28025032	2F	Al	32	100,00	106	65	30	40	10	224	0,69
40 T 10 36	28025036	2F	Al	36	112,75	119	70	30	40	10	225	0,87
40 T 10 40	28025040	2F	Al	40	125,45	131	80	30	40	10	226	1,07
40 T 10 44	28025044	2	Al	44	138,20		88	30	40	10		1,35
40 T 10 48	28025048	2	Al	48	150,95		95	30	40	16		1,52
40 T 10 60	28025060	2	Al	60	189,15		110	30	40	16		2,34



PULEGGE DENTATE PASSO METRICO SERIE "T" - DIN 7721-2

METRIC PULLEYS "T" - DIN 7721-2

T 10

PASSO 10 mm

PER CINGHIE LARGHEZZA 32 mm

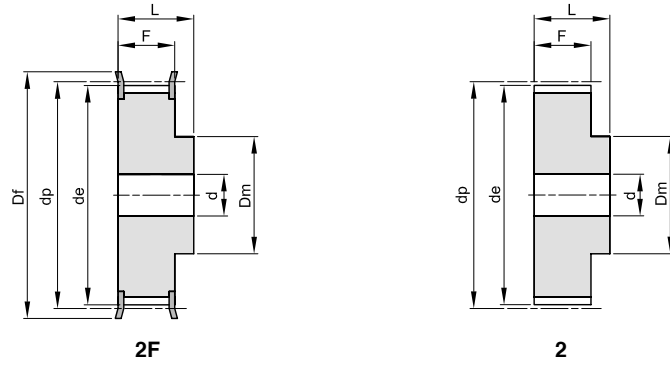

Materiale: Alluminio UNI 9006 - T6 (Al)
adatto per l'ossidazione dura a spessore

descrizione	codice	tipo	materiale	denti	de	Df	Dm	F	L	d	n° flangia	Kg.
47 T 10 18	28032018	2F	Al	18	55,45	60	40	37	47	10	214	0,25
47 T 10 19	28032019	2F	Al	19	58,65	66	44	37	47	10	216	0,29
47 T 10 20	28032020	2F	Al	20	61,80	66	46	37	47	12	216	0,32
47 T 10 22	28032022	2F	Al	22	68,20	75	52	37	47	12	218	0,39
47 T 10 24	28032024	2F	Al	24	74,55	83	58	37	47	12	219	0,47
47 T 10 25	28032025	2F	Al	25	77,75	83	60	37	47	12	219	0,53
47 T 10 26	28032026	2F	Al	26	80,90	87	60	37	47	12	220	0,56
47 T 10 27	28032027	2F	Al	27	84,10	91	60	37	47	12	221	0,60
47 T 10 28	28032028	2F	Al	28	87,25	93	60	37	47	12	222	0,64
47 T 10 30	28032030	2F	Al	30	93,65	97	60	37	47	12	223	0,74
47 T 10 32	28032032	2F	Al	32	100,00	106	65	37	47	12	224	0,84
47 T 10 36	28032036	2F	Al	36	112,75	119	70	37	47	16	225	1,06
47 T 10 40	28032040	2F	Al	40	125,45	131	80	37	47	16	226	1,32
47 T 10 44	28032044	2	Al	44	138,20		88	37	47	16		1,61
47 T 10 48	28032048	2	Al	48	150,95		95	37	47	16		1,93
47 T 10 60	28032060	2	Al	60	189,10		110	37	47	16		3,00



PULEGGE DENTATE PASSO METRICO SERIE "T" - DIN 7721-2

METRIC PULLEYS "T" - DIN 7721-2

T 10

PASSO 10 mm

PER CINGHIE LARGHEZZA 50 mm

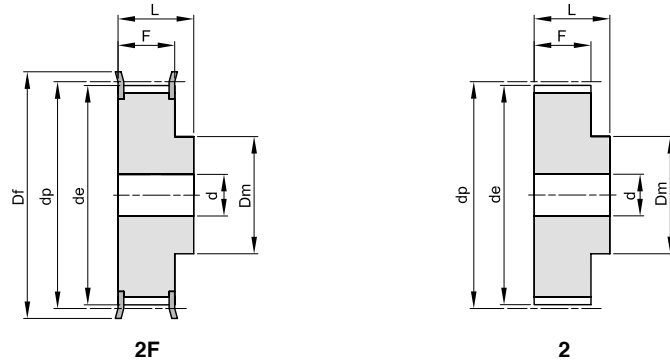

Materiale: Alluminio UNI 9006 - T6 (Al)
adatto per l'ossidazione dura a spessore

descrizione	codice	tipo	materiale	denti	de	Df	Dm	F	L	d	n° flangia	Kg.
66 T 10 18	28050018	2F	Al	18	55,45	60	40	56	66	10	214	0,42
66 T 10 19	28050019	2F	Al	19	58,65	66	44	56	66	10	216	0,47
66 T 10 20	28050020	2F	Al	20	61,80	66	46	56	66	12	216	0,52
66 T 10 22	28050022	2F	Al	22	68,20	75	52	56	66	12	218	0,57
66 T 10 24	28050024	2F	Al	24	74,55	83	58	56	66	12	219	0,74
66 T 10 25	28050025	2F	Al	25	77,75	83	60	56	66	12	219	0,77
66 T 10 26	28050026	2F	Al	26	80,90	87	60	56	66	12	220	0,82
66 T 10 27	28050027	2F	Al	27	84,10	91	60	56	66	12	221	0,95
66 T 10 28	28050028	2F	Al	28	87,25	93	60	56	66	12	222	0,96
66 T 10 30	28050030	2F	Al	30	93,65	97	60	56	66	12	223	1,17
66 T 10 32	28050032	2F	Al	32	100,00	106	65	56	66	12	224	1,30
66 T 10 36	28050036	2F	Al	36	112,75	119	70	56	66	16	225	1,64
66 T 10 40	28050040	2F	Al	40	125,45	131	80	56	66	16	226	2,00
66 T 10 44	28050044	2	Al	44	138,20		88	56	66	16		2,36
66 T 10 48	28050048	2	Al	48	150,95		95	56	66	16		2,83
66 T 10 60	28050060	2	Al	60	189,10		110	56	66	16		4,37



PULEGGE DENTATE PASSO METRICO SERIE BAT PER CINGHIE "AT" METRIC PULLEYS "AT"

BAT 5

PASSO 5 mm

PER CINGHIE AT LARGHEZZA 10 mm

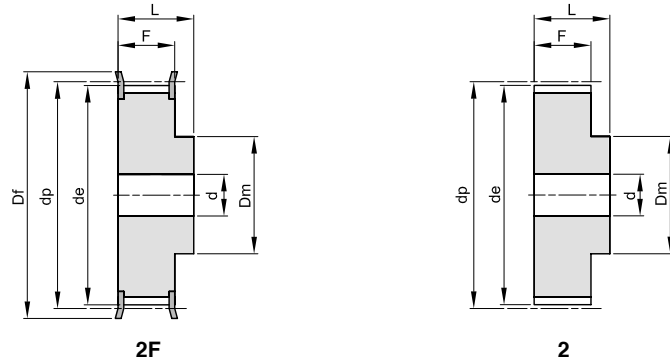

Materiale: Alluminio UNI 9006 - T6 (Al)
adatto per l'ossidazione dura a spessore

descrizione	codice	tipo	materiale	denti	de	Df	Dm	F	L	d	n° flangia	Kg.
21 BAT 5 12	60021012	2F	Al	12	17,85	23	10	15	21		201	0,01
21 BAT 5 14	60021014	2F	Al	14	21,05	25	13	15	21		203	0,02
21 BAT 5 15	60021015	2F	Al	15	22,65	28	16	15	21		204	0,02
21 BAT 5 16	60021016	2F	Al	16	24,20	32	18	15	21		205	0,03
21 BAT 5 18	60021018	2F	Al	18	27,40	32	20	15	21		205	0,03
21 BAT 5 19	60021019	2F	Al	19	29,00	36	22	15	21		206	0,04
21 BAT 5 20	60021020	2F	Al	20	30,60	36	23	15	21		206	0,04
21 BAT 5 22	60021022	2F	Al	22	33,85	38	24	15	21		207	0,05
21 BAT 5 24	60021024	2F	Al	24	37,00	42	26	15	21		208	0,06
21 BAT 5 25	60021025	2F	Al	25	38,55	44	26	15	21		209	0,06
21 BAT 5 26	60021026	2F	Al	26	40,20	44	26	15	21		209	0,06
21 BAT 5 27	60021027	2F	Al	27	41,80	48	30	15	21	8	210	0,07
21 BAT 5 28	60021028	2F	Al	28	43,35	48	32	15	21	8	210	0,07
21 BAT 5 30	60021030	2F	Al	30	46,55	51	34	15	21	8	211	0,07
21 BAT 5 32	60021032	2F	Al	32	49,70	54	38	15	21	8	212	0,09
21 BAT 5 36	60021036	2F	Al	36	56,05	63	38	15	21	8	215	0,11
21 BAT 5 40	60021040	2F	Al	40	62,45	66	40	15	21	8	216	0,14
21 BAT 5 42	60021042	2F	Al	42	65,60	71	40	15	21	8	217	0,18
21 BAT 5 44	60021044	2	Al	44	68,80		45	15	21	8		0,18
21 BAT 5 48	60021048	2	Al	48	75,15		50	15	21	8		0,20
21 BAT 5 60	60021060	2	Al	60	94,25		65	15	21	8		0,31



PULEGGE DENTATE PASSO METRICO SERIE BAT PER CINGHIE "AT" METRIC PULLEYS "AT"

BAT 5

PASSO 5 mm

PER CINGHIE AT LARGHEZZA 16 mm

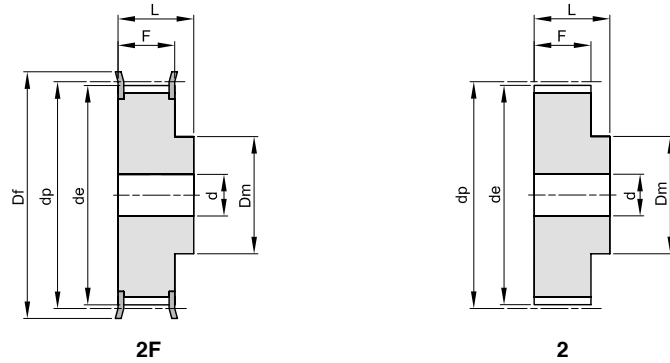

Materiale: Alluminio UNI 9006 - T6 (Al)
adatto per l'ossidazione dura a spessore

descrizione	codice	tipo	materiale	denti	de	Df	Dm	F	L	d	n° flangia	Kg.
27 BAT 5 12	60027012	2F	Al	12	17,85	23	10	21	27		201	0,02
27 BAT 5 14	60027014	2F	Al	14	21,05	25	13	21	27		203	0,03
27 BAT 5 15	60027015	2F	Al	15	22,65	28	16	21	27		204	0,03
27 BAT 5 16	60027016	2F	Al	16	24,20	32	18	21	27		205	0,04
27 BAT 5 18	60027018	2F	Al	18	27,40	32	20	21	27		205	0,04
27 BAT 5 19	60027019	2F	Al	19	29,00	36	22	21	27		206	0,05
27 BAT 5 20	60027020	2F	Al	20	30,60	36	23	21	27		206	0,06
27 BAT 5 22	60027022	2F	Al	22	33,85	38	24	21	27		207	0,06
27 BAT 5 24	60027024	2F	Al	24	37,00	42	26	21	27		208	0,08
27 BAT 5 25	60027025	2F	Al	25	38,55	44	26	21	27		209	0,08
27 BAT 5 26	60027026	2F	Al	26	40,20	44	26	21	27		209	0,09
27 BAT 5 27	60027027	2F	Al	27	41,80	48	30	21	27	8	210	0,09
27 BAT 5 28	60027028	2F	Al	28	43,35	48	32	21	27	8	210	0,09
27 BAT 5 30	60027030	2F	Al	30	46,55	51	34	21	27	8	211	0,10
27 BAT 5 32	60027032	2F	Al	32	49,70	54	38	21	27	8	212	0,12
27 BAT 5 36	60027036	2F	Al	36	56,05	63	38	21	27	8	215	0,16
27 BAT 5 40	60027040	2F	Al	40	62,45	66	40	21	27	8	216	0,19
27 BAT 5 42	60027042	2F	Al	42	65,60	71	40	21	27	8	217	0,20
27 BAT 5 44	60027044	2	Al	44	68,80		45	21	27	8		0,23
27 BAT 5 48	60027048	2	Al	48	75,15		50	21	27	8		0,28
27 BAT 5 60	60027060	2	Al	60	94,25		65	21	27	8		0,43



PULEGGE DENTATE PASSO METRICO SERIE BAT PER CINGHIE "AT" METRIC PULLEYS "AT"

BAT 5

PASSO 5 mm

PER CINGHIE AT LARGHEZZA 25 mm

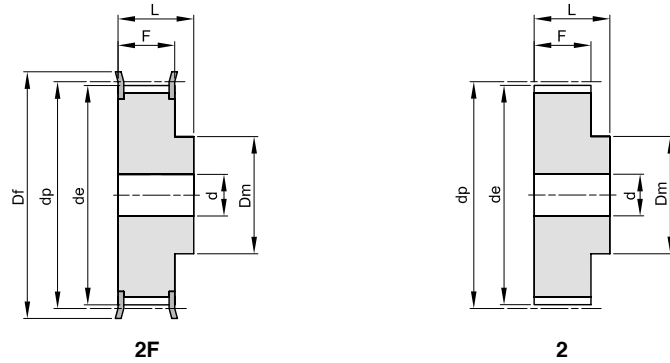

Materiale: Alluminio UNI 9006 - T6 (Al)
adatto per l'ossidazione dura a spessore

descrizione	codice	tipo	materiale	denti	de	Df	Dm	F	L	d	n° flangia	Kg.
36 BAT 5 12	60036012	2F	Al	12	17,85	23	10	30	36		201	0,03
36 BAT 5 14	60036014	2F	Al	14	21,05	25	13	30	36		203	0,04
36 BAT 5 15	60036015	2F	Al	15	22,65	28	16	30	36		204	0,04
36 BAT 5 16	60036016	2F	Al	16	24,20	32	18	30	36		205	0,05
36 BAT 5 18	60036018	2F	Al	18	27,40	32	20	30	36		205	0,06
36 BAT 5 19	60036019	2F	Al	19	29,00	36	22	30	36		206	0,07
36 BAT 5 20	60036020	2F	Al	20	30,60	36	23	30	36		206	0,08
36 BAT 5 22	60036022	2F	Al	22	33,85	38	24	30	36		207	0,08
36 BAT 5 24	60036024	2F	Al	24	37,00	42	26	30	36	8	208	0,11
36 BAT 5 25	60036025	2F	Al	25	38,55	44	26	30	36	8	209	0,12
36 BAT 5 26	60036026	2F	Al	26	40,20	44	26	30	36	8	209	0,12
36 BAT 5 27	60036027	2F	Al	27	41,80	48	30	30	36	8	210	0,13
36 BAT 5 28	60036028	2F	Al	28	43,35	48	32	30	36	8	210	0,14
36 BAT 5 30	60036030	2F	Al	30	46,55	51	34	30	36	8	211	0,15
36 BAT 5 32	60036032	2F	Al	32	49,70	54	38	30	36	8	212	0,18
36 BAT 5 36	60036036	2F	Al	36	56,05	63	38	30	36	8	215	0,23
36 BAT 5 40	60036040	2F	Al	40	62,45	66	40	30	36	8	216	0,28
36 BAT 5 42	60036042	2F	Al	42	65,60	71	40	30	36	8	217	0,29
36 BAT 5 44	60036044	2	Al	44	68,80		45	30	36	8		0,31
36 BAT 5 48	60036048	2	Al	48	75,15		50	30	36	8		0,40
36 BAT 5 60	60036060	2	Al	60	94,25		65	30	36	8		0,61



PULEGGE DENTATE PASSO METRICO SERIE BAT PER CINGHIE "AT" METRIC PULLEYS "AT"

BAT 10

PASSO 10 mm

PER CINGHIE AT LARGHEZZA 16 mm

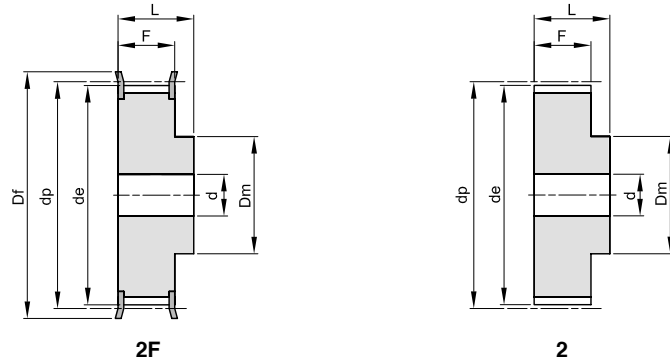

Materiale: Alluminio UNI 9006 - T6 (Al)
adatto per l'ossidazione dura a spessore

descrizione	codice	tipo	materiale	denti	de	Df	Dm	F	L	d	n° flangia	Kg.
31 BAT 10 15	61031015	2F	Al	15	45,90	51	32	21	31	8	211	0,12
31 BAT 10 16	61031016	2F	Al	16	49,10	54	35	21	31	8	212	0,13
31 BAT 10 18	61031018	2F	Al	18	55,45	60	40	21	31	8	214	0,17
31 BAT 10 19	61031019	2F	Al	19	58,65	66	44	21	31	8	216	0,18
31 BAT 10 20	61031020	2F	Al	20	61,80	66	46	21	31	8	216	0,21
31 BAT 10 22	61031022	2F	Al	22	68,20	75	52	21	31	8	218	0,25
31 BAT 10 24	61031024	2F	Al	24	74,55	83	58	21	31	8	219	0,29
31 BAT 10 25	61031025	2F	Al	25	77,75	83	60	21	31	8	219	0,31
31 BAT 10 26	61031026	2F	Al	26	80,90	87	60	21	31	8	220	0,36
31 BAT 10 27	61031027	2F	Al	27	84,05	91	60	21	31	8	221	0,37
31 BAT 10 28	61031028	2F	Al	28	87,25	93	60	21	31	8	222	0,40
31 BAT 10 30	61031030	2F	Al	30	93,65	97	60	21	31	8	223	0,44
31 BAT 10 32	61031032	2F	Al	32	100,00	106	65	21	31	10	224	0,49
31 BAT 10 36	61031036	2F	Al	36	112,75	119	70	21	31	10	225	0,62
31 BAT 10 40	61031040	2F	Al	40	125,45	131	80	21	31	10	226	0,77
31 BAT 10 44	61031044	2	Al	44	138,20		88	21	31	10		1,00
31 BAT 10 48	61031048	2	Al	48	150,95		95	21	31	16		1,10
31 BAT 10 60	61031060	2	Al	60	189,15		110	21	31	16		1,70



PULEGGE DENTATE PASSO METRICO SERIE BAT PER CINGHIE "AT" METRIC PULLEYS "AT"

BAT 10

PASSO 10 mm

PER CINGHIE AT LARGHEZZA 25 mm

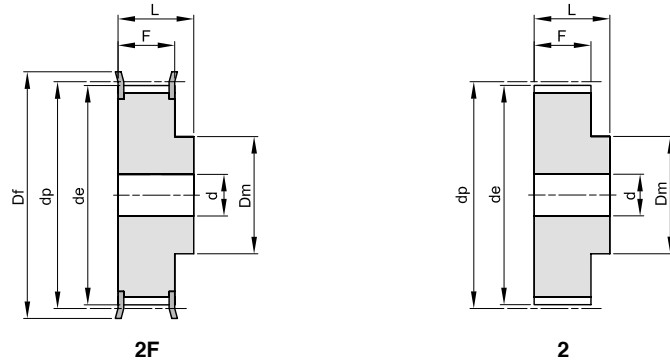

Materiale: Alluminio UNI 9006 - T6 (Al)
adatto per l'ossidazione dura a spessore

descrizione	codice	tipo	materiale	denti	de	Df	Dm	F	L	d	n° flangia	Kg.
40 BAT 10 15	61040015	2F	Al	15	45,90	51	32	30	40	8	211	0,15
40 BAT 10 16	61040016	2F	Al	16	49,10	54	35	30	40	8	212	0,18
40 BAT 10 18	61040018	2F	Al	18	55,45	60	40	30	40	8	214	0,22
40 BAT 10 19	61040019	2F	Al	19	58,65	66	44	30	40	8	216	0,25
40 BAT 10 20	61040020	2F	Al	20	61,80	66	46	30	40	8	216	0,28
40 BAT 10 22	61040022	2F	Al	22	68,20	75	52	30	40	8	218	0,34
40 BAT 10 24	61040024	2F	Al	24	74,55	83	58	30	40	8	219	0,39
40 BAT 10 25	61040025	2F	Al	25	77,75	83	60	30	40	8	219	0,42
40 BAT 10 26	61040026	2F	Al	26	80,90	87	60	30	40	8	220	0,48
40 BAT 10 27	61040027	2F	Al	27	84,05	91	60	30	40	8	221	0,54
40 BAT 10 28	61040028	2F	Al	28	87,25	93	60	30	40	8	222	0,55
40 BAT 10 30	61040030	2F	Al	30	93,65	97	60	30	40	8	223	0,64
40 BAT 10 32	61040032	2F	Al	32	100,00	106	65	30	40	10	224	0,69
40 BAT 10 36	61040036	2F	Al	36	112,75	119	70	30	40	10	225	0,87
40 BAT 10 40	61040040	2F	Al	40	125,45	131	80	30	40	10	226	1,07
40 BAT 10 44	61040044	2	Al	44	138,20		88	30	40	10		1,35
40 BAT 10 48	61040048	2	Al	48	150,95		95	30	40	16		1,52
40 BAT 10 60	61040060	2	Al	60	189,15		110	30	40	16		2,34



PULEGGE DENTATE PASSO METRICO SERIE BAT PER CINGHIE "AT" METRIC PULLEYS "AT"

BAT 10

PASSO 10 mm

PER CINGHIE AT LARGHEZZA 32 mm

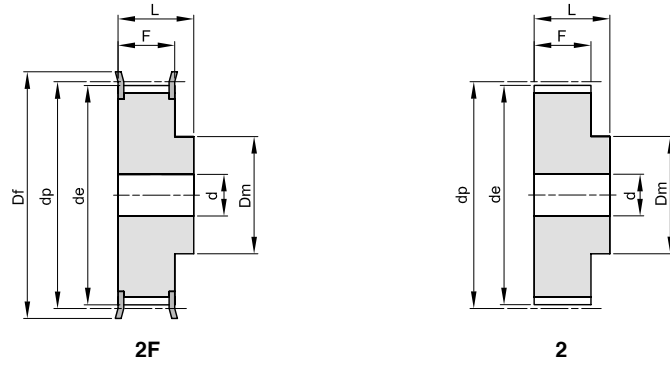

Materiale: Alluminio UNI 9006 - T6 (Al)
adatto per l'ossidazione dura a spessore

descrizione	codice	tipo	materiale	denti	de	Df	Dm	F	L	d	n° flangia	Kg.
47 BAT 10 18	61047018	2F	Al	18	55,45	60	40	37	47	10	214	0,25
47 BAT 10 19	61047019	2F	Al	19	58,65	66	44	37	47	10	216	0,29
47 BAT 10 20	61047020	2F	Al	20	61,80	66	46	37	47	12	216	0,32
47 BAT 10 22	61047022	2F	Al	22	68,20	75	52	37	47	12	218	0,39
47 BAT 10 24	61047024	2F	Al	24	74,55	83	58	37	47	12	219	0,47
47 BAT 10 25	61047025	2F	Al	25	77,75	83	60	37	47	12	219	0,53
47 BAT 10 26	61047026	2F	Al	26	80,90	87	60	37	47	12	220	0,56
47 BAT 10 27	61047027	2F	Al	27	84,05	91	60	37	47	12	221	0,60
47 BAT 10 28	61047028	2F	Al	28	87,25	93	60	37	47	12	222	0,64
47 BAT 10 30	61047030	2F	Al	30	93,65	97	60	37	47	12	223	0,74
47 BAT 10 32	61047032	2F	Al	32	100,00	106	65	37	47	12	224	0,84
47 BAT 10 36	61047036	2F	Al	36	112,75	119	70	37	47	16	225	1,06
47 BAT 10 40	61047040	2F	Al	40	125,45	131	80	37	47	16	226	1,32
47 BAT 10 44	61047044	2	Al	44	138,20		88	37	47	16		1,61
47 BAT 10 48	61047048	2	Al	48	150,95		95	37	47	16		1,93
47 BAT 10 60	61047060	2	Al	60	189,15		110	37	47	16		3,00



PULEGGE DENTATE PASSO METRICO SERIE BAT PER CINGHIE "AT" METRIC PULLEYS "AT"

BAT 10

PASSO 10 mm

PER CINGHIE AT LARGHEZZA 50 mm

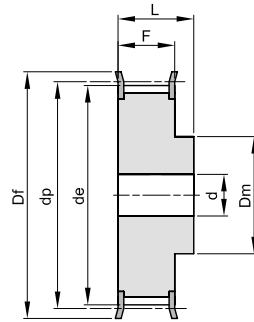

2F

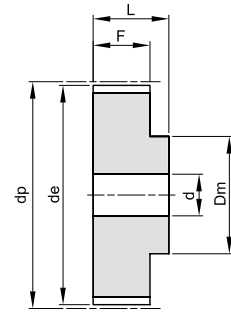

2

Materiale: Alluminio UNI 9006 - T6 (Al)
adatto per l'ossidazione dura a spessore

descrizione	codice	tipo	materiale	denti	de	Df	Dm	F	L	d	n° flangia	Kg.
66 BAT 10 18	61066018	2F	Al	18	55,45	60	40	56	66	10	214	0,42
66 BAT 10 19	61066019	2F	Al	19	58,65	66	44	56	66	10	216	0,47
66 BAT 10 20	61066020	2F	Al	20	61,80	66	46	56	66	12	216	0,52
66 BAT 10 22	61066022	2F	Al	22	68,20	75	52	56	66	12	218	0,57
66 BAT 10 24	61066024	2F	Al	24	74,55	83	58	56	66	12	219	0,74
66 BAT 10 25	61066025	2F	Al	25	77,75	83	60	56	66	12	219	0,77
66 BAT 10 26	61066026	2F	Al	26	80,90	87	60	56	66	12	220	0,82
66 BAT 10 27	61066027	2F	Al	27	84,05	91	60	56	66	12	221	0,95
66 BAT 10 28	61066028	2F	Al	28	87,25	93	60	56	66	12	222	0,96
66 BAT 10 30	61066030	2F	Al	30	93,65	97	60	56	66	12	223	1,17
66 BAT 10 32	61066032	2F	Al	32	100,00	106	65	56	66	12	224	1,30
66 BAT 10 36	61066036	2F	Al	36	112,75	119	70	56	66	16	225	1,64
66 BAT 10 40	61066040	2F	Al	40	125,45	131	80	56	66	16	226	2,00
66 BAT 10 44	61066044	2	Al	44	138,20		88	56	66	16		2,36
66 BAT 10 48	61066048	2	Al	48	150,95		95	56	66	16		2,83
66 BAT 10 60	61066060	2	Al	60	189,15		110	56	66	16		4,37



BARRE DENTATE PER CINGHIE POSITIVE - ISO 5294

TIMING BELT BARS - ISO 5294

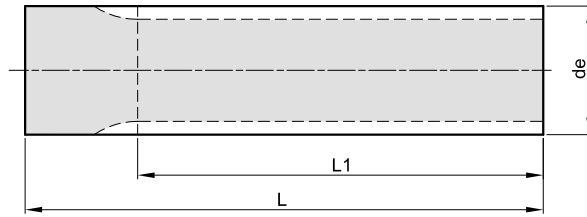

MXL PASSO 0,080" (2,032 mm)

MATERIALE: ALLUMINIO UNI 9006 - T6

descrizione	codice	Z	de	L1	L	n° flangia adattabile	Kg.
MXL 12	22000012	12	7,25	50	75	100	0,01
MXL 14	22000014	14	8,55	50	75	100	0,01
MXL 15	22000015	15	9,19	50	75	100	0,01
MXL 16	22000016	16	9,84	50	75	101	0,02
MXL 18	22000018	18	11,13	50	75	102	0,02
MXL 20	22000020	20	12,43	90	120	102	0,04
MXL 22	22000022	22	13,72	125	140	104	0,05
MXL 24	22000024	24	15,02	125	140	104	0,06
MXL 25	22000025	25	15,66	125	140	105	0,07
MXL 26	22000026	26	16,31	125	140	106	0,08
MXL 28	22000028	28	17,60	125	140	107	0,09
MXL 30	22000030	30	18,90	125	140	107	0,10
MXL 32	22000032	32	20,19	125	140	108	0,12
MXL 34	22000034	34	21,48	125	140	108	0,13
MXL 36	22000036	36	22,78	140	140	109	0,15
MXL 38	22000038	38	24,07	140	140	109	0,17
MXL 40	22000040	40	25,36	140	140	110	0,19
MXL 42	22000042	42	26,66	140	140	110	0,20
MXL 44	22000044	44	27,95	140	140	111	0,23
MXL 45	22000045	45	28,60	140	140	111	0,24
MXL 48	22000048	48	30,54	140	140	111	0,27
MXL 50	22000050	50	31,83	140	140	112	0,30
MXL 60	22000060	60	38,30	160	160	113	0,49
MXL 70	22000070	70	44,77	160	160	211	0,67
MXL 72	22000072	72	46,06	160	160	211	0,72

XL PASSO 1/5" (5,08 mm)

MATERIALE: ALLUMINIO UNI 9006 - T6

descrizione	codice	Z	de	L1	L	n° flangia adattabile	Kg.
XL 10	23000010	10	15,66	140	140	201	0,07
XL 11	23000011	11	17,28	140	140	201	0,08
XL 12	23000012	12	18,90	140	140	203	0,10
XL 13	23000013	13	20,51	140	140	203	0,11
XL 14	23000014	14	22,13	140	140	204	0,13
XL 15	23000015	15	23,75	140	140	204	0,16
XL 16	23000016	16	25,36	140	140	205	0,18
XL 17	23000017	17	26,98	140	140	205	0,20
XL 18	23000018	18	28,60	140	140	206	0,23
XL 19	23000019	19	30,22	140	140	206	0,26
XL 20	23000020	20	31,83	140	140	207	0,28
XL 21	23000021	21	33,45	160	160	207	0,36
XL 22	23000022	22	35,07	160	160	208	0,40
XL 23	23000023	23	36,60	160	160	208	0,44
XL 24	23000024	24	38,30	160	160	209	0,48
XL 25	23000025	25	39,92	160	160	210	0,51
XL 26	23000026	26	41,53	160	160	210	0,56
XL 27	23000027	27	43,15	160	160	210	0,60
XL 28	23000028	28	44,77	160	160	211	0,65
XL 29	23000029	29	46,39	160	160	211	0,70
XL 30	23000030	30	48,00	160	160	212	0,75
XL 32	23000032	32	51,24	160	160	213	0,87
XL 33	23000033	33	52,85	160	160	213	0,92
XL 34	23000034	34	54,47	160	160	214	0,98
XL 35	23000035	35	56,09	160	160	215	1,04
XL 36	23000036	36	57,70	160	160	216	1,10
XL 38	23000038	38	60,94	160	160	217	1,23
XL 39	23000039	39	62,56	160	160	217	1,30
XL 40	23000040	40	64,17	160	160	217	1,37
XL 41	23000041	41	65,79	160	160	218	1,43
XL 42	23000042	42	67,41	160	160	218	1,51
XL 43	23000043	43	69,02	160	160	313	1,58
XL 44	23000044	44	70,64	160	160	313	1,65
XL 48	23000048	48	77,11	160	160	220	1,98
XL 56	23000056	56	90,04	160	160	223	2,71
XL 60	23000060	60	96,51	160	160	320	3,10
XL 72	23000072	72	115,92	160	160	326	4,52



BARRE DENTATE PER CINGHIE POSITIVE - ISO 5294

TIMING BELT BARS - ISO 5294

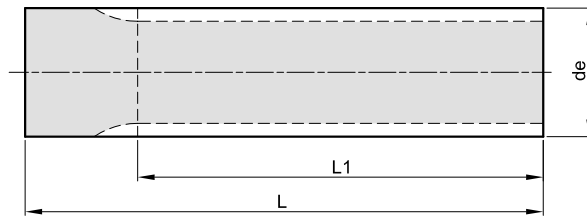

L PASSO 3/8" (9,525 mm)

MATERIALE: ALLUMINIO UNI 9006 - T6

descrizione	codice	Z	de	L1	L	n° flangia adattabile	Kg.
L 10	24000010	10	29,56	140	140	300	0,23
L 11	24000011	11	32,59	140	140	301	0,28
L 12	24000012	12	35,62	160	160	302	0,39
L 13	24000013	13	38,65	160	160	303	0,46
L 14	24000014	14	41,68	160	160	304	0,55
L 15	24000015	15	44,72	160	160	305	0,63
L 16	24000016	16	47,75	160	160	306	0,73
L 17	24000017	17	50,78	160	160	307	0,82
L 18	24000018	18	53,81	160	160	308	0,93
L 19	24000019	19	56,84	160	160	309	1,04
L 20	24000020	20	59,88	160	160	310	1,16
L 21	24000021	21	62,91	160	160	311	1,28
L 22	24000022	22	65,94	160	160	312	1,41
L 23	24000023	23	68,97	160	160	313	1,55
L 24	24000024	24	72,00	160	160	313	1,69
L 27	24000027	27	81,10	160	160	315	2,15
L 30	24000030	30	90,20	160	160	318	2,67

L PASSO 3/8" (9,525 mm)

MATERIALE: ACCIAIO

descrizione	codice	Z	de	L1	L	n° flangia adattabile	Kg.
L 10	24100010	10	29,56	140	140	300	0,66
L 11	24100011	11	32,59	140	140	301	0,81
L 12	24100012	12	35,62	160	160	302	1,12
L 13	24100013	13	38,65	160	160	303	1,32
L 14	24100014	14	41,68	160	160	304	1,57
L 15	24100015	15	44,72	160	160	305	1,81
L 16	24100016	16	47,75	160	160	306	2,08
L 17	24100017	17	50,78	160	160	307	2,34
L 18	24100018	18	53,81	160	160	308	2,64
L 19	24100019	19	56,84	160	160	309	2,96
L 20	24100020	20	59,88	160	160	310	3,32
L 21	24100021	21	62,91	160	160	311	3,67
L 22	24100022	22	65,94	160	160	312	4,07
L 23	24100023	23	68,97	160	160	313	4,44
L 24	24100024	24	72,00	160	160	313	4,86
L 27	24100027	27	81,10	160	160	315	6,20
L 30	24100030	30	90,20	160	160	318	7,72



BARRE DENTATE PER CINGHIE HTD®

HTD® TIMING BELT BARS

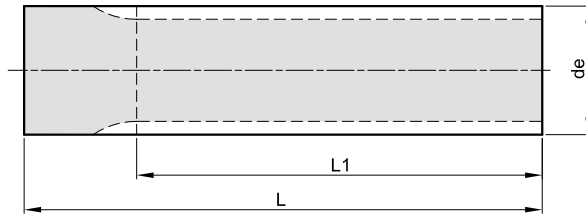

HTD 5M PASSO 5 mm

MATERIALE: ALLUMINIO UNI 9006 - T6

descrizione	codice	Z	de	L1	L	n° flangia adattabile	Kg.
5M 12	50000012	12	17,96	160	160	202	0,08
5M 13	50000013	13	19,55	160	160	203	0,10
5M 14	50000014	14	21,14	175	200	203	0,16
5M 15	50000015	15	22,73	175	200	204	0,19
5M 16	50000016	16	24,32	175	200	204	0,21
5M 17	50000017	17	25,92	175	200	205	0,24
5M 18	50000018	18	27,51	200	200	205	0,27
5M 19	50000019	19	29,10	200	200	205	0,31
5M 20	50000020	20	30,69	200	200	206	0,35
5M 21	50000021	21	32,28	200	200	207	0,39
5M 22	50000022	22	33,87	200	200	207	0,43
5M 23	50000023	23	35,47	200	200	208	0,48
5M 24	50000024	24	37,06	200	200	208	0,52
5M 25	50000025	25	38,65	200	200	209	0,57
5M 26	50000026	26	40,24	200	200	209	0,62
5M 27	50000027	27	41,83	200	200	210	0,67
5M 28	50000028	28	43,42	200	200	210	0,73
5M 30	50000030	30	46,61	200	200	211	0,84
5M 32	50000032	32	49,79	200	200	212	0,97
5M 34	50000034	34	52,97	200	200	213	1,11
5M 36	50000036	36	56,16	200	200	214	1,25
5M 38	50000038	38	59,34	200	200	216	1,40
5M 40	50000040	40	62,52	200	200	217	1,55
5M 42	50000042	42	65,71	200	200	218	1,73
5M 44	50000044	44	68,89	200	200	218	1,90
5M 45	50000045	45	70,48	200	200	313	1,99
5M 48	50000048	48	75,25	200	200	219	2,27
5M 50	50000050	50	78,44	200	200	220	2,48
5M 60	50000060	60	94,35	200	200	320	3,60
5M 72	50000072	72	113,45	200	200	225	5,28

HTD 8M PASSO 8 mm

MATERIALE: ACCIAIO

descrizione	codice	Z	de	L1	L	n° flangia adattabile	Kg.
8M 18	51000018	18	44,47	200	200	304	2,03
8M 19	51000019	19	47,01	200	200	305	2,30
8M 20	51000020	20	49,56	200	200	306	2,57
8M 21	51000021	21	52,11	200	200	307	2,88
8M 22	51000022	22	54,65	200	200	308	3,18
8M 23	51000023	23	57,20	200	200	309	3,52
8M 24	51000024	24	59,75	200	200	310	3,86
8M 25	51000025	25	62,29	200	200	310	4,23
8M 26	51000026	26	64,84	200	200	311	4,60
8M 28	51000028	28	69,93	200	200	312	5,40
8M 30	51000030	30	75,02	200	200	314	6,27
8M 32	51000032	32	80,12	200	200	315	7,20
8M 34	51000034	34	85,21	200	200	316	8,20
8M 35	51000035	35	87,76	200	200	317	8,71
8M 36	51000036	36	90,30	200	200	319	9,26
8M 38	51000038	38	95,40	200	200	320	10,39
8M 40	51000040	40	100,49	200	200	321	11,58
8M 44	51000044	44	110,68	200	200	325	14,16
8M 48	51000048	48	120,86	200	200	327	16,99



BARRE DENTATE "PCB" PER CINGHIE SYNCHROCHAIN "PCB" TIMING BELTS BARS

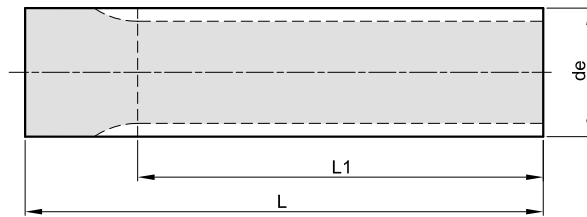

PCB 8M PASSO 8 mm MATERIALE: ACCIAIO

descrizione	codice	Z	de	L1	L	n° flangia adattabile	Kg.
* 8M 22	PCB51000022	22	54,42	180	180	308	3,20
* 8M 25	PCB51000025	25	62,06	180	180	310	4,20
* 8M 28	PCB51000028	28	69,70	180	180	312	5,20
* 8M 30	PCB51000030	30	74,79	180	180	314	6,00
* 8M 32	PCB51000032	32	79,89	180	180	315	6,90
* 8M 34	PCB51000034	34	84,98	180	180	316	7,80
* 8M 36	PCB51000036	36	90,07	180	180	319	8,90
* 8M 38	PCB51000038	38	95,17	180	180	320	10,00
* 8M 40	PCB51000040	40	100,26	200	200	321	12,30
* 8M 45	PCB51000045	45	112,99	200	200	325	15,40
* 8M 48	PCB51000048	48	120,63	200	200	327	17,70
* 8M 50	PCB51000050	50	125,72	200	200	328	18,20
* 8M 56	PCB51000056	56	141,00	200	200	333	24,50
* 8M 60	PCB51000060	60	151,19	200	200	335	28,10
* 8M 64	PCB51000064	64	161,37	200	200	338	31,80
* 8M 75	PCB51000075	75	189,39	200	200	342	44,00

PCB 14M PASSO 14 mm MATERIALE: ACCIAIO

descrizione	codice	Z	de	L1	L	n° flangia adattabile	Kg.
* 14M 28	PCB52000028	28	121,98	200	200	400	18,00
* 14M 30	PCB52000030	30	130,89	200	200	401	20,80
* 14M 32	PCB52000032	32	139,80	200	200	403	23,80
* 14M 34	PCB52000034	34	148,72	200	200	404	27,00
* 14M 36	PCB52000036	36	157,63	200	200	405	30,30
* 14M 38	PCB52000038	38	166,54	200	200	406	33,90
* 14M 40	PCB52000040	40	175,45	200	200	407	37,70
* 14M 44	PCB52000044	44	193,28	200	200	411	45,90
* 14M 48	PCB52000048	48	211,11	200	200	412	54,80



BARRE DENTATE PASSO METRICO SERIE "T" - DIN 7721-2

METRIC BARS "T" - DIN 7721-2

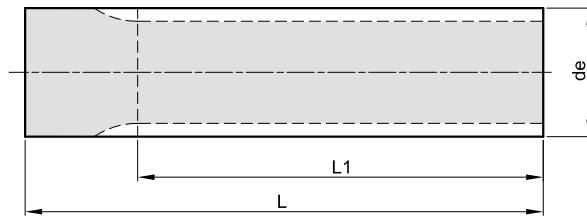

T 2,5 PASSO 2,5 mm

MATERIALE: ALLUMINIO UNI 9006 - T6

descrizione	codice	Z	de	L1	L	n° flangia adattabile	Kg.
T 2,5 10	34000010	10	7,42	50	75		0,01
T 2,5 12	34000012	12	9,00	50	75	100	0,01
T 2,5 13	34000013	13	9,80	50	75	100	0,02
T 2,5 14	34000014	14	10,60	50	75	101	0,02
T 2,5 15	34000015	15	11,40	75	75	101	0,02
T 2,5 16	34000016	16	12,20	75	75	102	0,02
T 2,5 17	34000017	17	13,00	75	75	104	0,03
T 2,5 18	34000018	18	13,80	75	75	104	0,03
T 2,5 19	34000019	19	14,60	120	120	104	0,05
T 2,5 20	34000020	20	15,40	120	120	105	0,05
T 2,5 21	34000021	21	16,20	120	120	105	0,06
T 2,5 22	34000022	22	17,00	140	140	106	0,08
T 2,5 24	34000024	24	18,55	140	140	107	0,09
T 2,5 26	34000026	26	20,15	140	140	108	0,12
T 2,5 27	34000027	27	20,95	140	140	108	0,13
T 2,5 28	34000028	28	21,75	140	140	108	0,14
T 2,5 29	34000029	29	22,55	140	140	109	0,15
T 2,5 30	34000030	30	23,35	140	140	109	0,15
T 2,5 32	34000032	32	24,95	140	140	110	0,18
T 2,5 34	34000034	34	26,55	140	140	110	0,21
T 2,5 35	34000035	35	27,35	140	140	110	0,21
T 2,5 36	34000036	36	28,10	140	140	111	0,22
T 2,5 38	34000038	38	29,70	140	140	111	0,26
T 2,5 40	34000040	40	31,30	140	140	112	0,27
T 2,5 42	34000042	42	32,90	140	140	112	0,32
T 2,5 44	34000044	44	34,50	140	140	113	0,33
T 2,5 45	34000045	45	35,30	140	140	113	0,37
T 2,5 48	34000048	48	37,70	140	140	208	0,40
T 2,5 50	34000050	50	39,29	160	160	209	0,52
T 2,5 60	34000060	60	47,25	160	160	211	0,72
T 2,5 65	34000065	65	51,20	160	160	213	0,87
T 2,5 70	34000070	70	55,20	160	160	215	1,05
T 2,5 72	34000072	72	56,80	160	160	215	1,11
T 2,5 90	34000090	90	71,12	160	160	219	1,75
T 2,5 100	34000100	100	79,08	160	160	220	2,18





BARRE DENTATE PASSO METRICO SERIE "T" - DIN 7721-2

METRIC BARS "T" - DIN 7721-2

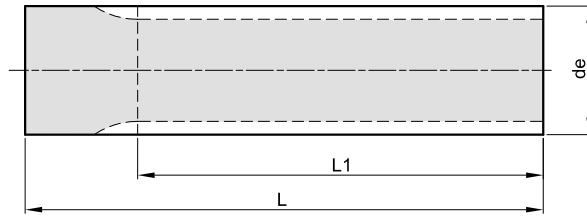

T 5 PASSO 5 mm

MATERIALE: ALLUMINIO UNI 9006 - T6

descrizione	codice	Z	de	L1	L	n° flangia adattabile	Kg.
T 5 10	35000010	10	15,05	140	140	200	0,06
T 5 11	35000011	11	16,65	140	140	201	0,07
T 5 12	35000012	12	18,25	140	140	201	0,09
T 5 13	35000013	13	19,85	140	140	203	0,10
T 5 14	35000014	14	21,45	140	140	203	0,12
T 5 15	35000015	15	23,05	140	140	204	0,14
T 5 16	35000016	16	24,60	140	140	205	0,16
T 5 17	35000017	17	26,20	140	140	205	0,19
T 5 18	35000018	18	27,80	140	140	205	0,21
T 5 19	35000019	19	29,40	140	140	206	0,24
T 5 20	35000020	20	31,00	160	160	206	0,31
T 5 21	35000021	21	32,70	160	160	207	0,33
T 5 22	35000022	22	34,25	160	160	207	0,36
T 5 23	35000023	23	35,85	160	160	208	0,39
T 5 24	35000024	24	37,40	160	160	208	0,43
T 5 25	35000025	25	38,95	160	160	209	0,47
T 5 26	35000026	26	40,60	160	160	209	0,51
T 5 27	35000027	27	42,20	160	160	210	0,55
T 5 28	35000028	28	43,75	160	160	210	0,60
T 5 29	35000029	29	45,35	160	160	211	0,65
T 5 30	35000030	30	46,95	160	160	211	0,70
T 5 32	35000032	32	50,10	160	160	212	0,80
T 5 34	35000034	34	53,25	160	160	213	0,91
T 5 35	35000035	35	54,85	160	160	214	0,98
T 5 36	35000036	36	56,45	160	160	215	1,02
T 5 37	35000037	37	58,06	160	160	215	1,08
T 5 38	35000038	38	59,65	160	160	216	1,14
T 5 40	35000040	40	62,85	160	160	216	1,27
T 5 42	35000042	42	66,00	160	160	217	1,41
T 5 44	35000044	44	69,20	160	160	218	1,55
T 5 45	35000045	45	70,80	160	160	313	1,63
T 5 46	35000046	46	72,40	160	160	313	1,69
T 5 48	35000048	48	75,55	160	160	219	1,85
T 5 50	35000050	50	78,75	160	160	220	2,02
T 5 60	35000060	60	94,65	160	160	320	2,95
T 5 72	35000072	72	113,75	160	160	225	4,28
T 5 80	35000080	80	126,48	160	160	226	5,39
T 5 90	35000090	90	142,40	160	160	333	6,76
T 5 100	35000100	100	158,31	160	160	338	8,34

T 10 PASSO 10 mm

MATERIALE: ALLUMINIO UNI 9006 - T6

descrizione	codice	Z	de	L1	L	n° flangia adattabile	Kg.
T 10 10	36000010	10	29,98	140	140	206	0,22
T 10 11	36000011	11	33,16	140	140	207	0,29
T 10 12	36000012	12	36,35	140	140	208	0,34
T 10 13	36000013	13	39,55	140	140	209	0,42
T 10 14	36000014	14	42,70	160	160	210	0,55
T 10 15	36000015	15	45,90	160	160	211	0,64
T 10 16	36000016	16	49,10	160	160	212	0,74
T 10 17	36000017	17	52,25	160	160	213	0,85
T 10 18	36000018	18	55,45	160	160	214	0,96
T 10 19	36000019	19	58,65	160	160	216	1,07
T 10 20	36000020	20	61,80	160	160	216	1,20
T 10 21	36000021	21	65,00	160	160	217	1,29
T 10 22	36000022	22	68,20	160	160	218	1,43
T 10 23	36000023	23	71,35	160	160	313	1,58
T 10 24	36000024	24	74,55	160	160	219	1,73
T 10 26	36000026	26	80,90	160	160	220	2,05
T 10 28	36000028	28	87,25	160	160	222	2,39
T 10 30	36000030	30	93,65	160	160	223	2,76
T 10 32	36000032	32	100,00	160	160	224	3,18
T 10 34	36000034	34	106,40	160	160	323	3,61
T 10 36	36000036	36	112,75	160	160	225	4,06
T 10 38	36000038	38	119,10	160	160	327	4,62
T 10 40	36000040	40	125,45	160	160	226	5,13
T 10 45	36000045	45	141,40	160	160	333	6,50
T 10 48	36000048	48	150,95	160	160	335	7,39
T 10 60	36000060	60	189,15	160	160	342	11,76
T 10 72	36000072	72	227,29	160	160		17,03



BARRE DENTATE PASSO METRICO SERIE BAT PER CINGHIE "AT" METRIC BARS "AT"

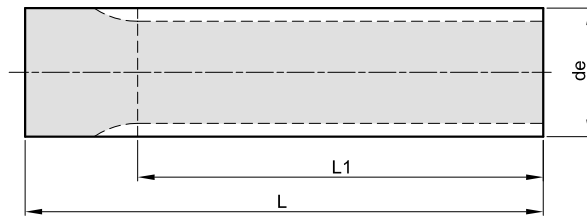

BAT 5 PASSO 5 mm

MATERIALE: ALLUMINIO UNI 9006 - T6

descrizione	codice	Z	de	L1	L	n° flangia adattabile	Kg.
BAT 5 12	68000012	12	17,85	140	140	201	0,08
BAT 5 13	68000013	13	19,45	140	140	203	0,10
BAT 5 14	68000014	14	21,05	140	140	203	0,12
BAT 5 15	68000015	15	22,65	140	140	204	0,14
BAT 5 16	68000016	16	24,20	140	140	205	0,15
BAT 5 17	68000017	17	25,80	140	140	205	0,18
BAT 5 18	68000018	18	27,40	140	140	205	0,20
BAT 5 19	68000019	19	29,00	140	140	206	0,23
BAT 5 20	68000020	20	30,60	160	160	206	0,30
BAT 5 21	68000021	21	32,30	160	160	207	0,33
BAT 5 22	68000022	22	33,85	160	160	207	0,36
BAT 5 23	68000023	23	35,45	160	160	208	0,40
BAT 5 24	68000024	24	37,00	160	160	208	0,44
BAT 5 25	68000025	25	38,55	160	160	209	0,47
BAT 5 26	68000026	26	40,20	160	160	209	0,51
BAT 5 27	68000027	27	41,80	160	160	210	0,55
BAT 5 28	68000028	28	43,35	160	160	210	0,60
BAT 5 30	68000030	30	46,55	160	160	211	0,69
BAT 5 32	68000032	32	49,70	160	160	212	0,81
BAT 5 34	68000034	34	52,85	160	160	213	0,90
BAT 5 36	68000036	36	56,05	160	160	215	1,02
BAT 5 38	68000038	38	59,25	160	160	216	1,14
BAT 5 40	68000040	40	62,45	160	160	216	1,28
BAT 5 42	68000042	42	65,60	160	160	217	1,41
BAT 5 44	68000044	44	68,80	160	160	218	1,55
BAT 5 46	68000046	46	72,00	160	160	313	1,70
BAT 5 48	68000048	48	75,15	160	160	219	1,85
BAT 5 52	68000052	52	81,55	160	160	220	2,19
BAT 5 56	68000056	56	87,90	160	160	222	2,55
BAT 5 58	68000058	58	91,10	160	160	223	2,74
BAT 5 60	68000060	60	94,25	160	160	320	2,94
BAT 5 64	68000064	64	100,65	160	160	224	3,36
BAT 5 72	68000072	72	113,35	160	160	225	4,29

BAT 10 PASSO 10 mm

MATERIALE: ALLUMINIO UNI 9006 - T6

descrizione	codice	Z	de	L1	L	n° flangia adattabile	Kg.
BAT 10 15	69000015	15	45,90	160	160	211	0,62
BAT 10 16	69000016	16	49,10	160	160	212	0,72
BAT 10 17	69000017	17	52,25	160	160	213	0,82
BAT 10 18	69000018	18	55,45	160	160	214	0,94
BAT 10 19	69000019	19	58,65	160	160	216	1,05
BAT 10 20	69000020	20	61,80	160	160	216	1,17
BAT 10 21	69000021	21	65,00	160	160	217	1,31
BAT 10 22	69000022	22	68,20	160	160	218	1,44
BAT 10 23	69000023	23	71,35	160	160	313	1,60
BAT 10 24	69000024	24	74,55	160	160	219	1,75
BAT 10 25	69000025	25	77,75	160	160	219	1,91
BAT 10 26	69000026	26	80,90	160	160	220	2,06
BAT 10 27	69000027	27	84,05	160	160	221	2,23
BAT 10 28	69000028	28	87,25	160	160	222	2,42
BAT 10 30	69000030	30	93,65	160	160	223	2,79
BAT 10 32	69000032	32	100,00	160	160	224	3,20
BAT 10 34	69000034	34	106,40	160	160	323	3,65
BAT 10 36	69000036	36	112,75	160	160	225	4,09
BAT 10 38	69000038	38	119,10	160	160	327	4,59
BAT 10 40	69000040	40	125,45	160	160	226	5,16
BAT 10 42	69000042	42	131,85	160	160	330	5,65
BAT 10 44	69000044	44	138,20	160	160	331	6,22
BAT 10 46	69000046	46	144,55	160	160	334	6,84
BAT 10 48	69000048	48	150,95	160	160	335	7,45
BAT 10 52	69000052	52	163,65	160	160	338	8,93
BAT 10 56	69000056	56	176,40	160	160	339	10,39
BAT 10 58	69000058	58	182,75	160	160	340	10,96
BAT 10 60	69000060	60	189,15	160	160	342	11,78
BAT 10 70	69000070	70	220,95	160	160		16,18



DIMENSIONI FLANGE PER PULEGGE DENTATE - ZINCATE

PULLEYS FLANGES DIMENSIONS ZINC PLATED

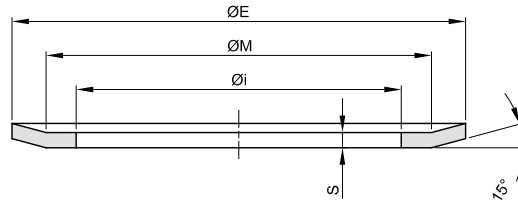

n° flangia	codice	spessore S = 0,5 mm		
		Ø E	Ø M	Ø i
100	5030000100	13	10	6
101	5030000101	15	12	8
102	5030000102	16	13	9,5
104	5030000104	18	15	11,5
105	5030000105	19,5	17,5	12
106	5030000106	23	17,5	12
107	5030000107	23	20	14
108	5030000108	25	22	15
109	5030000109	28	24	18
110	5030000110	32	28	21,5
111	5030000111	36	31	25
112	5030000112	38	34	28
113	5030000113	42	38	30,5
114	5030000114	48	43,5	37

n° flangia	codice	spessore S = 1 mm		
		Ø E	Ø M	Ø i
200	5030000200	19,5	17,5	12
201	5030000201	23	17,5	12
202	5030000202	23	20	14
203	5030000203	25	22	15
204	5030000204	28	24	18
205	5030000205	32	28	21,5
206	5030000206	36	31	25
207	5030000207	38	34	28
208	5030000208	42	38	30,5
209	5030000209	44	40	33
210	5030000210	48	43,5	37
211	5030000211	51	47,5	40
212	5030000212	54	50,5	43
213	5030000213	57	53	46
214	5030000214	60	57	47
215	5030000215	63	57	48
216	5030000216	66	61,5	52
217	5030000217	71	65	56
218	5030000218	75	68,5	60
219	5030000219	83	76,5	68
220	5030000220	87	82,5	72
221	5030000221	91	85,5	76
222	5030000222	93	89	80
223	5030000223	97	93	83
224	5030000224	106	101	90
225	5030000225	119	113,5	103
226	5030000226	131	125,5	115



DIMENSIONI FLANGE PER PULEGGE DENTATE - ZINCATE PULLEYS FLANGES DIMENSIONS ZINC PLATED

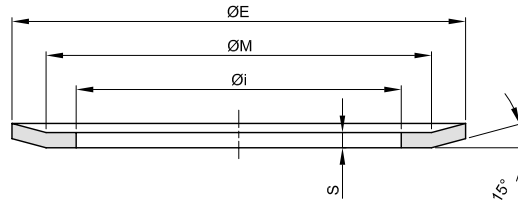

n° flangia	codice	spessore S = 1,5 mm		
		Ø E	Ø M	Ø i
300	5030000300	36	31	25
301	5030000301	38	34	28
302	5030000302	42	38	30,5
303	5030000303	44	40	33
304	5030000304	48	43,5	37
305	5030000305	51	47,5	40
306	5030000306	54	50,5	43
307	5030000307	57	53	46
308	5030000308	60	57	47
309	5030000309	63	57	48
310	5030000310	66	61,5	52
311	5030000311	71	65	56
312	5030000312	75	68,5	60
313	5030000313	79	73,5	64
314	5030000314	83	76,5	68
315	5030000315	87	82,5	72
316	5030000316	91	85,5	76
317	5030000317	93	89	80
318	5030000318	97	93	83
319	5030000319	98	92	79,3
320	5030000320	103	97	86
321	5030000321	106	101	90
322	5030000322	111	106	94
323	5030000323	115	110	99
325	5030000325	119	113,5	103
326	5030000326	123	117,5	107
327	5030000327	127	122	111
328	5030000328	135	130	119
330	5030000330	140	134,5	123
331	5030000331	143	139	127
333	5030000333	148	143	132
334	5030000334	152	147,5	136
335	5030000335	158	154	142
338	5030000338	168	163	149,5
339	5030000339	184	179	165
340	5030000340	192	187	173
342	5030000342	200	195	181

n° flangia	codice	spessore S = 2,5 mm		
		Ø E	Ø M	Ø i
400	5030000400	127	120,2	104,7
401	5030000401	138	130	108
402	5030000402	146	138	116
403	5030000403	154	146	122
404	5030000404	160	150	128
405	5030000405	168	162	135
406	5030000406	183	170	145
407	5030000407	188	180	158
409	5030000409	198	188	165
410	5030000410	200	192,8	172
411	5030000411	211	198	173
412	5030000412	226	214	190
414	5030000414	240	224	192
415	5030000415	256	240	220
416	5030000416	256	247	225
418	5030000418	296	287	252



CODICE NUMERICO FLANGE PER PULEGGE DENTATE

CODES OF FLANGES FOR TIMING PULLEYS

n° denti puleggia	MXL SP. 0,5	XL SP. 1	L SP. 1,5	H SP. 1,5	XH SP. 2,5	HTD 3M SP. 0,5	HTD 5M SP. 1	HTD 8M SP. 1,5	HTD 14M SP. 2,5	PCB 8M SP. 1,5	PCB 14M SP. 2,5	T 2,5 SP. 0,5	T 5 SP. 1	T 10 SP. 1	BAT 5 SP. 1	BAT 10 SP. 1
10		201	300			100							200	206		
11		201	301										201	207		
12	100	203	302			101	202					100	201	208	201	208
13		203	303				203					100	203	209	203	
14	100	204	304	309		102	203					101	203	210	203	210
15	100	204	305	310		104	204					101	204	211	204	211
16	101	205	306	311		104	204					102	205	212	205	212
17		205	307	312			205					104	205	213	205	213
18	102	206	308	313	401	105	205	304				104	205	214	205	214
19		206	309	314	402		205	305				104	206	216	206	216
20	102	207	310	315	403	107	206	306				105	206	216	206	216
21		207	311	316	404	108	207	307				105	207	217	207	217
22	104	208	312	317	405	108	207	308		308		106	207	218	207	218
23		208	313	318			208	309					208	313	208	313
24	104	209	313	320	406	108	208	310				107	208	219	208	219
25	105	210	314	321	407		209	310		310		107	209	219	209	219
26	106	210	315	322	409	109	209	311				108	209	220	209	220
27		210	315	323	410		210					108	210	221	210	221
28	107	211	316	325	411	110	210	312	400	312	400	108	210	222	210	222
29		211		326								109	211			
30	107	212	318	327	412	110	211	314	401	314	401	109	211	223	211	223
32	108	213	320	328	414	111	212	315	403	315	403	110	212	224	212	224
33		213	321	330												
34	108	214	322	331	415		213	316	404	316	404	110	213	323	213	323
35		215	322	333				317				110	214			
36	109	216	323	334		112	214	319	405		405	111	215	225	215	225
37													215			
38	109	217		335			216	320	406	320	406	111	216	327	216	327
39		217														
40	110	217	327	338		113	217	321	407	321	407	112	216	226	216	226
41		218														
42	110	218	328				218					112	217		217	330
43		313														
44	111	313	330	339		114	218	325	411		411	113	218		218	331
45	111		331	340			313			325		113	313	333		
46													313		313	334
48	111	220	334	342			219	327	412	327	412	208	219	335	219	335
50	112						220			328	414	209	220			
52															220	338
56		223					222	333	416	333	416				222	339
58															223	340
60	113	320					320			335		211	320	342	320	342
64							224	338	418	338						224
65												213				
70	211											215			224	
72	211	326					225	340				215	225		225	
75										342						
80													226			
90												219	333			
100												220	338			



PIASTRE DI BLOCCAGGIO PER CINGHIE DENTATE CLAMPING BELT PLATES

Le piastre di bloccaggio per cinghie sono utilizzate per fissare le estremità della cinghia qualora si voglia ottenere, dal moto rotatorio delle pulegge, un moto rettilineo alternato per tavole o altri dispositivi.

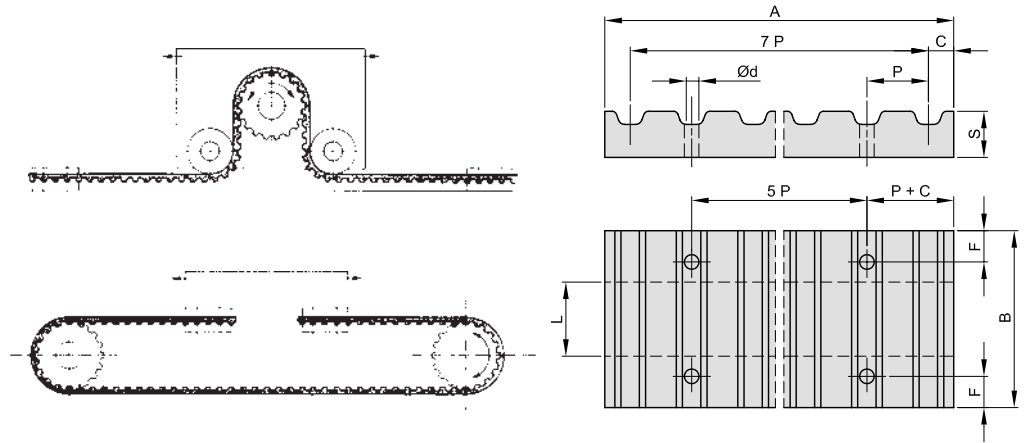

Materiale: Alluminio

descrizione	codice	passo	A	B	Ø d	F	C	S	L	Kg.
XL 025	5010013025	5,08	42,5	25,5	5,5	6	3,5	8	6,4	0,02
XL 037	5010013037	5,08	42,5	28,5	5,5	6	3,5	8	9,5	0,02
L 050	5010014050	9,525	76,6	39	9	8	5	15	12,7	0,10
L 075	5010014075	9,525	76,6	45	9	8	5	15	19,1	0,12
L 100	5010014100	9,525	76,6	51,5	9	8	5	15	25,4	0,14
H 050	5010015050	12,70	106,9	45	11	10	9	22	12,7	0,25
H 075	5010015075	12,70	106,9	51	11	10	9	22	19,1	0,28
H 100	5010015100	12,70	106,9	57,5	11	10	9	22	25,4	0,32
5M 9	5010041009	5	41,5	28	5,5	6	3,2	8	9	0,02
5M 15	5010041015	5	41,5	34	5,5	6	3,2	8	15	0,03
5M 25	5010041025	5	41,5	44	5,5	6	3,2	8	25	0,04
8M 20	5010042020	8	66	45	9	8	5	15	20	0,10
8M 30	5010042030	8	66	55	9	8	5	15	30	0,12
8M 50	5010042050	8	66	75	9	8	5	15	50	0,17
8M 85	5010042085	8	66	110	9	8	5	15	85	0,25
14M 40	5010043040	14	116	71	11	10	9	22	40	0,40
14M 55	5010043055	14	116	86	11	10	9	22	55	0,50
14M 85	5010043085	14	116	116	11	10	9	22	85	0,68
14M 115	5010043115	14	116	146	11	10	9	22	115	0,85
14M 170	5010043170	14	116	201	11	10	9	22	170	1,14
T 5 10	5010027010	5	41,8	29	5,5	6	3,4	8	10	0,02
T 5 16	5010027016	5	41,8	35	5,5	6	3,4	8	16	0,03
T 5 25	5010027025	5	41,8	44	5,5	6	3,4	8	25	0,04
T10 16	5010028016	10	80	41	9	8	5	15	16	0,11
T10 25	5010028025	10	80	50	9	8	5	15	25	0,14
T10 32	5010028032	10	80	57	9	8	5	15	32	0,16
T10 50	5010028050	10	80	75	9	8	5	15	50	0,22
AT5 10	5010060010	5	41,8	29	5,5	6	3,4	8	10	0,02
AT5 16	5010060016	5	41,8	35	5,5	6	3,4	8	16	0,03
AT5 25	5010060025	5	41,8	44	5,5	6	3,4	8	25	0,04
AT10 16	5010061016	10	80	41	9	8	5	15	16	0,11
AT10 25	5010061025	10	80	50	9	8	5	15	25	0,14
AT10 32	5010061032	10	80	57	9	8	5	15	32	0,16
AT10 50	5010061050	10	80	75	9	8	5	15	50	0,22





PULEGGE A GOLE TRAPEZOIDALI PER BUSSOLA CONICA V-BELTS PULLEYS FOR TAPER BUSH

Descrizione e caratteristiche - Description and features

Le pulegge per cinghie trapezoidali sono costruite secondo le specifiche ISO 4183 / DIN 2211
Our V-belt pulleys are manufactured according to International Standard ISO 4183 / DIN 2211

Materiale - Material

Ghisa EN-GJL-200 (G20 - UNI 5007)
Cast iron EN-GJL-200 (G20 - UNI 5007)

Trattamento e Bilanciatura

Protective treatment and balancing

Tutte le pulegge standard sono protette con un trattamento superficiale di FOSFATAZIONE e BILANCIATE STATICAMENTE per essere idonee ad un funzionamento fino alla velocità periferica di 35 m/sec.

The surface of all our standard pulleys is protected by phosphated treatment.
All the pulleys are Statically Balanced and can be used for peripheric speed up to 35 m/sec



Calcolo della velocità periferica (Vp)

Periferic speed table (Vp)

$$V_p = \frac{\pi \cdot dp \cdot n}{60 \cdot 1000} = \frac{dp \cdot n}{19100} \text{ m/sec}$$

dp = diametro in mm - diameter/mm
n = giri al minuto - revolutions per minute
Vp = velocità in m/s - speed m/s

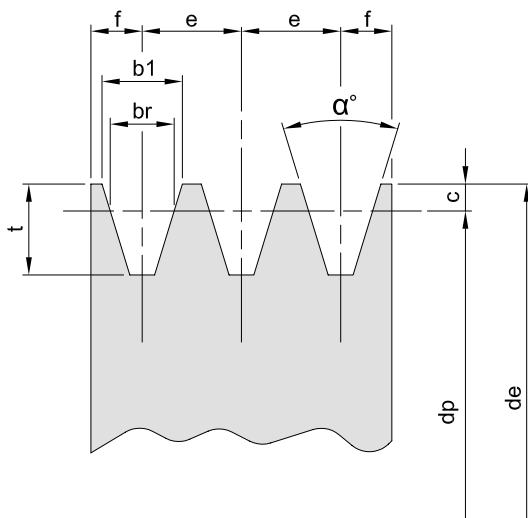

Dimensioni puleggia
Dimensions of Pulley

codice	dp mm	α gradi	b1 mm	br mm	e mm	f mm	c mm	t mm
SPZ (mm)	< 80	34°	9,7	8,5	12	8	2	11
	> 80	38°						
SPA (mm)	< 118	34°	12,7	11	15	10	2,8	13,8
	> 118	38°						
SPB (mm)	< 190	34°	16,3	14	19	12,5	3,5	17,5
	> 190	38°						
SPC (mm)	< 315	34°	22,0	19	25,5	17	4,8	23,8
	> 315	38°						



PULEGGE A GOLE TRAPEZOIDALI PER BUSSOLA CONICA V-BELTS PULLEYS FOR TAPER BUSH

SPZ - 1

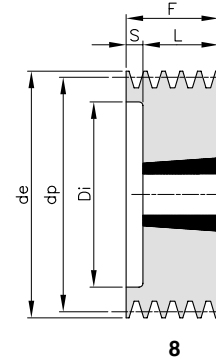
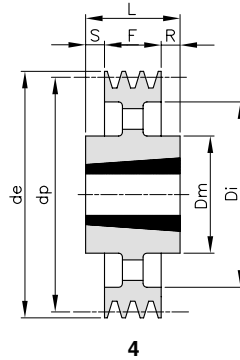
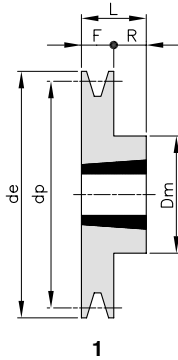

Materiale: GHISA EN-GJL-200 / *Materiale Acciaio

descrizione	codice	gole	dp	de	tipo	bussola	foro max	Dm	Di	E	F	L	R	S	Kg.
*SPZ 50 01	TZ010050	1	50	54	8	1008	25		26		37	25		12	0,35
*SPZ 56 01	TZ010056	1	56	60	8	1008	25		32		37	25		12	0,47
*SPZ 60 01	TZ010060	1	60	64	1	1008	25				22	22			0,29
SPZ 63 01	TZ010063	1	63	67	1	1108	28	56			16	22	6		0,24
SPZ 67 01	TZ010067	1	67	71	1	1108	28	60			16	22	6		0,29
SPZ 71 01	TZ010071	1	71	75	1	1108	28	60			16	22	6		0,34
SPZ 75 01	TZ010075	1	75	79	1	1108	28	60			16	22	6		0,40
SPZ 80 01	TZ010080	1	80	84	1	1210	32	75			16	25	9		0,49
SPZ 85 01	TZ010085	1	85	89	1	1210	32	80			16	25	9		0,60
SPZ 90 01	TZ010090	1	90	94	1	1210	32	80			16	25	9		0,67
SPZ 95 01	TZ010095	1	95	99	1	1210	32	85			16	25	9		0,80
SPZ 100 01	TZ010100	1	100	104	1	1210	32	85			16	25	9		0,88
SPZ 106 01	TZ010106	1	106	110	1	1610	42	92			16	25	9		0,92
SPZ 112 01	TZ010112	1	112	116	1	1610	42	92			16	25	9		1,04
SPZ 118 01	TZ010118	1	118	122	1	1610	42	92			16	25	9		1,16
SPZ 125 01	TZ010125	1	125	129	1	1610	42	92			16	25	9		1,31
SPZ 132 01	TZ010132	1	132	136	1	1610	42	92			16	25	9		1,47
SPZ 140 01	TZ010140	1	140	144	1	1610	42	92			16	25	9		1,65
SPZ 150 01	TZ010150	1	150	154	1	1610	42	92			16	25	9		1,91
SPZ 160 01	TZ010160	1	160	164	1	1610	42	92			16	25	9		2,20
SPZ 170 01	TZ010170	1	170	174	1	1610	42	92			16	25	9		2,48
SPZ 180 01	TZ010180	1	180	184	4	1610	42	92	152		16	25	9		1,87
SPZ 190 01	TZ010190	1	190	194	4	1610	42	92	162		16	25	9		2,04
SPZ 200 01	TZ010200	1	200	204	4	2012	50	112	171		16	32	16		2,81
SPZ 224 01	TZ010224	1	224	228	4	2012	50	112	195		16	32	16		3,78
SPZ 250 01	TZ010250	1	250	254	4	2012	50	112	221		16	32	8	8	3,40
SPZ 280 01	TZ010280	1	280	284	4	2012	50	112	251		16	32	8	8	3,64
SPZ 315 01	TZ010315	1	315	319	4	2012	50	112	286		16	32	8	8	4,34
SPZ 355 01	TZ010355	1	355	359	4	2012	50	112	326		16	32	8	8	5,12
SPZ 400 01	TZ010400	1	400	404	4	2012	50	112	371		16	32	8	8	6,08
SPZ 450 01	TZ010450	1	450	454	4	2517	65	124	421		16	45	14,5	14,5	7,15



PULEGGE A GOLE TRAPEZOIDALI PER BUSSOLA CONICA V-BELTS PULLEYS FOR TAPER BUSH

SPZ - 2

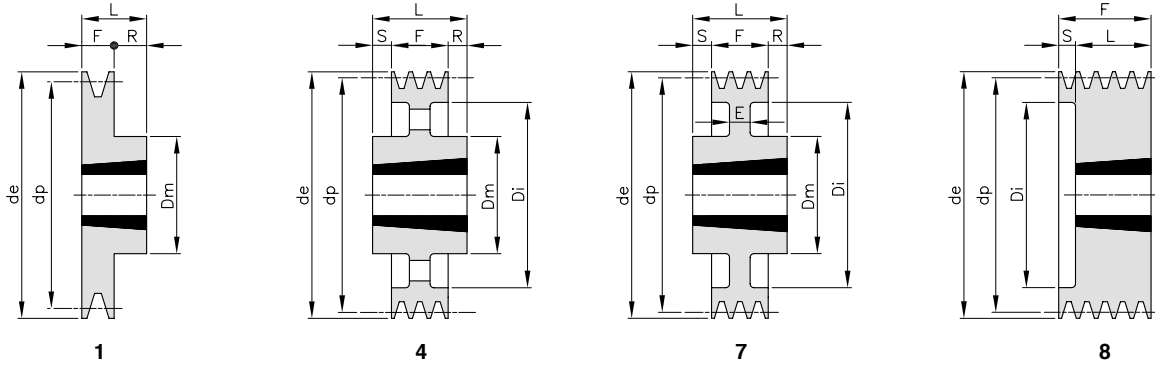

Materiale: GHISA EN-GJL-200 / *Materiale Acciaio

descrizione	codice	gole	dp	de	tipo	bussola	foro max	Dm	Di	E	F	L	R	S	Kg.
*SPZ 50 02	TZ020050	2	50	54	8	1008	25		26		50	25		25	0,46
*SPZ 56 02	TZ020056	2	56	60	8	1008	25		32		49	22		27	0,57
SPZ 60 02	TZ020060	2	60	64	8	1108	28		36		49	22		27	0,60
SPZ 63 02	TZ020063	2	63	67	8	1108	28		40		28	22		6	0,30
SPZ 67 02	TZ020067	2	67	71	8	1108	28		42		28	22		6	0,35
SPZ 71 02	TZ020071	2	71	75	8	1108	28		42		28	22		6	0,44
SPZ 75 02	TZ020075	2	75	79	8	1210	32		51		28	25		3	0,40
SPZ 80 02	TZ020080	2	80	84	8	1210	32		51		28	25		3	0,50
SPZ 85 02	TZ020085	2	85	89	8	1610	42		60		28	25		3	0,51
SPZ 90 02	TZ020090	2	90	94	8	1610	42		61		28	25		3	0,62
SPZ 95 02	TZ020095	2	95	99	8	1610	42		66		28	25		3	0,75
SPZ 100 02	TZ020100	2	100	104	8	1610	42		71		28	25		3	0,90
SPZ 106 02	TZ020106	2	106	110	8	1610	42		76		28	25		3	1,06
SPZ 112 02	TZ020112	2	112	116	8	1610	42		83		28	25		3	1,23
SPZ 118 02	TZ020118	2	118	122	8	1610	42		90		28	25		3	1,43
SPZ 125 02	TZ020125	2	125	129	8	1610	42		96		28	25		3	1,66
SPZ 132 02	TZ020132	2	132	136	8	1610	42		103		28	25		3	1,93
SPZ 140 02	TZ020140	2	140	144	8	1610	42		111		28	25		3	2,20
SPZ 150 02	TZ020150	2	150	154	1	2012	50	112			28	32	4		2,75
SPZ 160 02	TZ020160	2	160	164	1	2012	50	112			28	32	4		3,20
SPZ 170 02	TZ020170	2	170	174	1	2012	50	112			28	32	4		3,75
SPZ 180 02	TZ020180	2	180	184	7	2012	50	112	152	10	28	32	4		3,23
SPZ 190 02	TZ020190	2	190	194	7	2012	50	112	162	10	28	32	4		3,47
SPZ 200 02	TZ020200	2	200	204	4	2012	50	112	171		28	32	4		3,50
SPZ 224 02	TZ020224	2	224	228	4	2012	50	112	195		28	32	4		3,87
SPZ 250 02	TZ020250	2	250	254	4	2012	50	112	221		28	32	2	2	4,29
SPZ 280 02	TZ020280	2	280	284	4	2012	50	112	251		28	32	2	2	4,90
SPZ 315 02	TZ020315	2	315	319	4	2012	50	112	286		28	32	2	2	5,47
SPZ 355 02	TZ020355	2	355	359	4	2012	50	112	326		28	32	2	2	6,23
SPZ 400 02	TZ020400	2	400	404	4	2517	65	124	371		28	45	8,5	8,5	9,04
SPZ 450 02	TZ020450	2	450	454	4	2517	65	124	421		28	45	8,5	8,5	9,80
SPZ 500 02	TZ020500	2	500	504	4	2517	65	124	471		28	45	8,5	8,5	10,22



PULEGGE A GOLE TRAPEZOIDALI PER BUSSOLA CONICA V-BELTS PULLEYS FOR TAPER BUSH

SPZ - 3

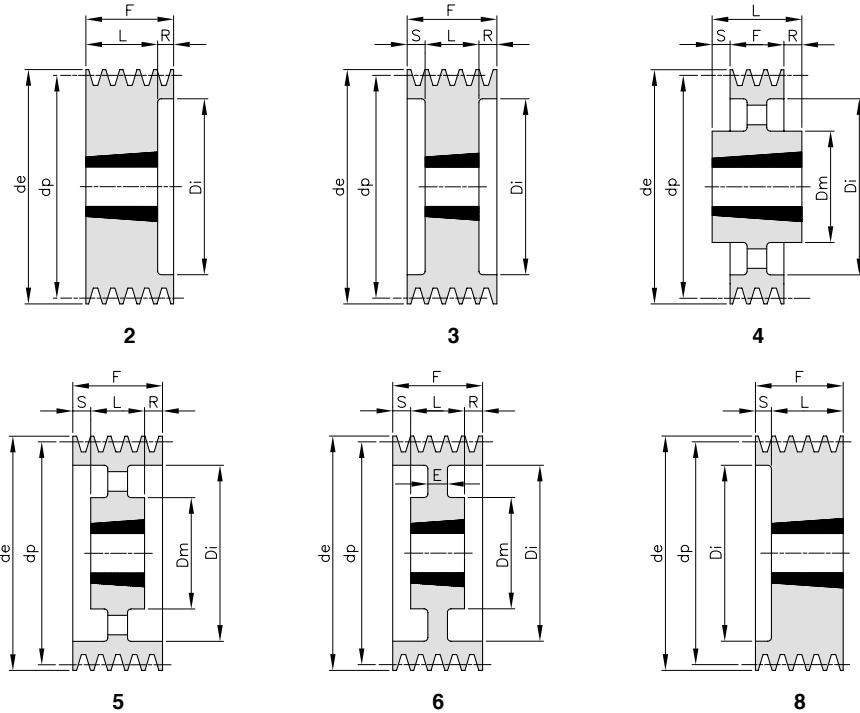

Materiale: GHISA EN-GJL-200

descrizione	codice	gole	dp	de	tipo	bussola	foro max	Dm	Di	E	F	L	R	S	Kg.
SPZ 63 03	TZ030063	3	63	67	8	1108	28		40	40	22		18	0,40	
SPZ 67 03	TZ030067	3	67	71	8	1108	28		42	40	22		18	0,48	
SPZ 71 03	TZ030071	3	71	75	8	1108	28		42	40	22		18	0,60	
SPZ 75 03	TZ030075	3	75	79	8	1210	32		51	40	25		15	0,80	
SPZ 80 03	TZ030080	3	80	84	8	1210	32		51	40	25		15	0,80	
SPZ 85 03	TZ030085	3	85	89	8	1610	42		60	40	25		15	0,80	
SPZ 90 03	TZ030090	3	90	94	8	1610	42		61	40	25		15	0,90	
SPZ 95 03	TZ030095	3	95	99	8	1610	42		66	40	25		15	1,10	
SPZ 100 03	TZ030100	3	100	104	8	1610	42		71	40	25		15	1,20	
SPZ 106 03	TZ030106	3	106	110	8	1610	42		76	40	25		15	1,40	
SPZ 112 03	TZ030112	3	112	116	8	2012	50		83	40	32		8	1,50	
SPZ 118 03	TZ030118	3	118	122	8	2012	50		90	40	32		8	1,60	
SPZ 125 03	TZ030125	3	125	129	2	2012	50		96	40	32	8		2,00	
SPZ 132 03	TZ030132	3	132	136	2	2012	50		103	40	32	8		2,40	
SPZ 140 03	TZ030140	3	140	144	2	2012	50		111	40	32	8		2,80	
SPZ 150 03	TZ030150	3	150	154	2	2012	50		121	40	32	8		3,40	
SPZ 160 03	TZ030160	3	160	164	2	2012	50		131	40	32	8		3,60	
SPZ 170 03	TZ030170	3	170	174	3	2012	50		141	40	32	4	4	3,70	
SPZ 180 03	TZ030180	3	180	184	6	2012	50	106	151	7	40	32	8	3,70	
SPZ 190 03	TZ030190	3	190	194	6	2012	50	112	161	10	40	32	4	4	4,00
SPZ 200 03	TZ030200	3	200	204	5	2012	50	112	171		40	32	4	4	4,30
SPZ 224 03	TZ030224	3	224	228	5	2012	50	112	195		40	32	4	4	4,70
SPZ 250 03	TZ030250	3	250	254	5	2012	50	112	221		40	32	4	4	5,40
SPZ 280 03	TZ030280	3	280	284	4	2517	65	124	251		40	45	2,5	2,5	6,50
SPZ 315 03	TZ030315	3	315	319	4	2517	65	124	286		40	45	2,5	2,5	7,80
SPZ 355 03	TZ030355	3	355	359	4	2517	65	124	326		40	45	2,5	2,5	8,90
SPZ 400 03	TZ030400	3	400	404	4	2517	65	124	371		40	45	2,5	2,5	9,10
SPZ 450 03	TZ030450	3	450	454	4	2517	65	124	421		40	45	2,5	2,5	9,70
SPZ 500 03	TZ030500	3	500	504	4	2517	65	124	471		40	45	2,5	2,5	13,50
SPZ 630 03	TZ030630	3	630	634	4	3020	75	150	601		40	51	5,5	5,5	19,30
SPZ 800 03	TZ030800	3	800	804	4	3020	75	150	771		40	51	5,5	5,5	30,00



PULEGGE A GOLE TRAPEZOIDALI PER BUSSOLA CONICA V-BELTS PULLEYS FOR TAPER BUSH

SPZ - 4

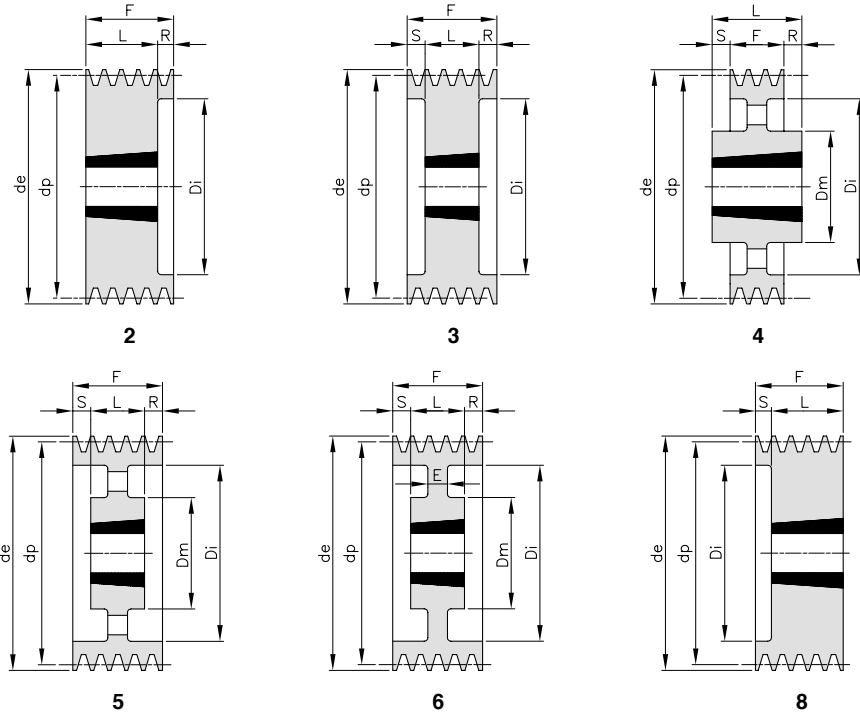

Materiale: GHISA EN-GJL-200

descrizione	codice	gole	dp	de	tipo	bussola	foro max	Dm	Di	E	F	L	R	S	Kg.	
SPZ 71 04	TZ040071	4	71	75	8	1108	28		42	52	22			30	0,80	
SPZ 80 04	TZ040080	4	80	84	8	1210	32		51	52	25			27	0,90	
SPZ 85 04	TZ040085	4	85	89	8	1610	42		60	52	25			27	1,00	
SPZ 90 04	TZ040090	4	90	94	8	1610	42		61	52	25			27	1,10	
SPZ 95 04	TZ040095	4	95	99	8	1610	42		66	52	25			27	1,20	
SPZ 100 04	TZ040100	4	100	104	8	1610	42		71	52	25			27	1,30	
SPZ 106 04	TZ040106	4	106	110	8	1610	42		76	52	25			27	1,40	
SPZ 112 04	TZ040112	4	112	116	8	2012	50		83	52	32			20	1,60	
SPZ 118 04	TZ040118	4	118	122	8	2012	50		90	52	32			20	1,90	
SPZ 125 04	TZ040125	4	125	129	2	2012	50		96	52	32		20		2,20	
SPZ 132 04	TZ040132	4	132	136	2	2012	50		103	52	32		20		2,60	
SPZ 140 04	TZ040140	4	140	144	2	2012	50		111	52	32		20		3,00	
SPZ 150 04	TZ040150	4	150	154	2	2517	65		121	52	45		7		3,60	
SPZ 160 04	TZ040160	4	160	164	2	2517	65		131	52	45		7		4,50	
SPZ 170 04	TZ040170	4	170	174	2	2517	65		141	52	45		7		4,80	
SPZ 180 04	TZ040180	4	180	184	2	2517	65		151	52	45		7		5,00	
SPZ 190 04	TZ040190	4	190	194	3	2517	65		161	52	45		3,5	3,5	5,10	
SPZ 200 04	TZ040200	4	200	204	6	2517	65	124	171	8	52		45	3,5	3,5	5,20
SPZ 224 04	TZ040224	4	224	228	5	2517	65	124	195		52		45	3,5	3,5	5,90
SPZ 250 04	TZ040250	4	250	254	5	2517	65	124	221		52		45	3,5	3,5	6,60
SPZ 280 04	TZ040280	4	280	284	5	2517	65	124	251		52		45	3,5	3,5	7,20
SPZ 315 04	TZ040315	4	315	319	5	2517	65	124	286		52		45	3,5	3,5	8,50
SPZ 355 04	TZ040355	4	355	359	5	2517	65	124	326		52		45	3,5	3,5	9,40
SPZ 400 04	TZ040400	4	400	404	5	2517	65	124	371		52		45	3,5	3,5	11,20
SPZ 450 04	TZ040450	4	450	454	5	3020	75	146	421		52		51	0,5	0,5	11,60
SPZ 500 04	TZ040500	4	500	504	5	3020	75	146	471		52		51	0,5	0,5	18,00
SPZ 630 04	TZ040630	4	630	634	4	3030	75	146	601		52		76	12	12	25,80
SPZ 800 04	TZ040800	4	800	804	4	3030	75	146	771		52		76	12	12	35,00



PULEGGE A GOLE TRAPEZOIDALI PER BUSSOLA CONICA V-BELTS PULLEYS FOR TAPER BUSH

SPZ - 5

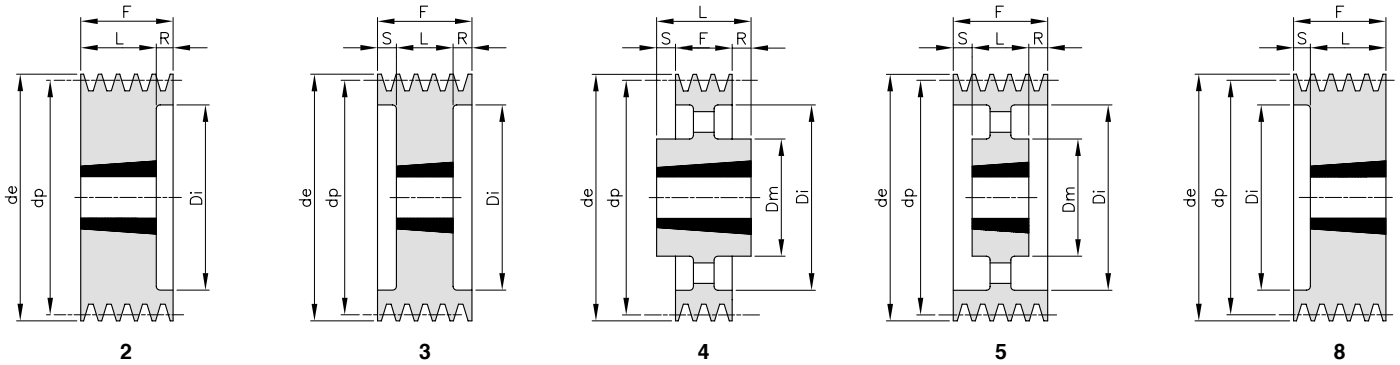

Materiale: GHISA EN-GJL-200

descrizione	codice	gole	dp	de	tipo	bussola	foro max	Dm	Di	E	F	L	R	S	Kg.
SPZ 85 05	TZ050085	5	85	89	8	1610	42		60	64	25			39	1,20
SPZ 90 05	TZ050090	5	90	94	8	1610	42		61	64	25			39	1,40
SPZ 95 05	TZ050095	5	95	99	8	1610	42		66	64	25			39	1,50
SPZ 100 05	TZ050100	5	100	104	8	2012	50		71	64	32			32	1,60
SPZ 106 05	TZ050106	5	106	110	8	2012	50		76	64	32			32	1,80
SPZ 112 05	TZ050112	5	112	116	8	2012	50		83	64	32			32	1,90
SPZ 118 05	TZ050118	5	118	122	8	2012	50		90	64	32			32	2,40
SPZ 125 05	TZ050125	5	125	129	8	2012	50		96	64	32			32	2,80
SPZ 132 05	TZ050132	5	132	136	8	2517	65		103	64	45			19	2,80
SPZ 140 05	TZ050140	5	140	144	2	2517	65		111	64	45	19			3,20
SPZ 150 05	TZ050150	5	150	154	2	2517	65		121	64	45	19			3,90
SPZ 160 05	TZ050160	5	160	164	2	2517	65		131	64	45	19			4,70
SPZ 170 05	TZ050170	5	170	174	2	2517	65		141	64	45	19			5,50
SPZ 180 05	TZ050180	5	180	184	2	2517	65		151	64	45	19			6,20
SPZ 190 05	TZ050190	5	190	194	3	2517	65		161	64	45	9,5	9,5		6,40
SPZ 200 05	TZ050200	5	200	204	3	2517	65		171	64	45	9,5	9,5		6,50
SPZ 224 05	TZ050224	5	224	228	5	2517	65	124	195	64	45	9,5	9,5		7,20
SPZ 250 05	TZ050250	5	250	254	5	2517	65	124	221	64	45	9,5	9,5		7,60
SPZ 280 05	TZ050280	5	280	284	5	2517	65	124	251	64	45	9,5	9,5		9,00
SPZ 315 05	TZ050315	5	315	319	5	2517	65	124	286	64	45	9,5	9,5		10,00
SPZ 355 05	TZ050355	5	355	359	5	2517	65	124	326	64	45	9,5	9,5		12,10
SPZ 400 05	TZ050400	5	400	404	5	3020	75	146	371	64	51	6,5	6,5		14,60
SPZ 450 05	TZ050450	5	450	454	5	3020	75	146	421	64	51	6,5	6,5		17,00
SPZ 500 05	TZ050500	5	500	504	4	3030	75	146	471	64	76	6	6		20,60
SPZ 630 05	TZ050630	5	630	634	4	3030	75	146	601	64	76	6	6		26,00
SPZ 800 05	TZ050800	5	800	804	4	3535	90	178	771	64	89	12,5	12,5		41,00



PULEGGE A GOLE TRAPEZOIDALI PER BUSSOLA CONICA V-BELTS PULLEYS FOR TAPER BUSH

SPZ - 6

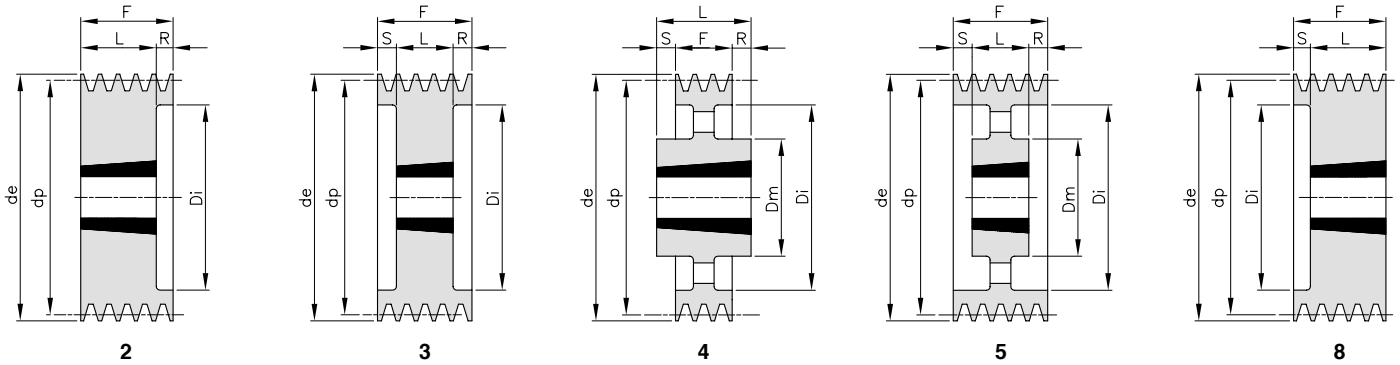

Materiale: GHISA EN-GJL-200

descrizione	codice	gole	dp	de	tipo	bussola	foro max	Dm	Di	E	F	L	R	S	Kg.
SPZ 90 06	TZ060090	6	90	94	8	1610	42		61	76	25			51	1,50
SPZ 95 06	TZ060095	6	95	99	8	1610	42		66	76	25			51	1,70
SPZ 100 06	TZ060100	6	100	104	8	2012	50		71	76	32			44	1,80
SPZ 106 06	TZ060106	6	106	110	8	2012	50		76	76	32			44	2,00
SPZ 112 06	TZ060112	6	112	116	8	2012	50		83	76	32			44	2,20
SPZ 118 06	TZ060118	6	118	122	8	2517	65		90	76	45			31	2,40
SPZ 125 06	TZ060125	6	125	129	8	2517	65		96	76	45			31	2,90
SPZ 132 06	TZ060132	6	132	136	8	2517	65		103	76	45			31	3,20
SPZ 140 06	TZ060140	6	140	144	2	2517	65		111	76	45		31		3,50
SPZ 150 06	TZ060150	6	150	154	2	2517	65		121	76	45		31		4,50
SPZ 160 06	TZ060160	6	160	164	2	2517	65		131	76	45		31		5,50
SPZ 170 06	TZ060170	6	170	174	2	2517	65		141	76	45		31		6,50
SPZ 180 06	TZ060180	6	180	184	3	2517	65		151	76	45		15,5	15,5	6,50
SPZ 190 06	TZ060190	6	190	194	3	2517	65		161	76	45		15,5	15,5	6,40
SPZ 200 06	TZ060200	6	200	204	3	2517	65		171	76	45		15,5	15,5	6,20
SPZ 224 06	TZ060224	6	224	228	5	2517	65	124	195	76	45		15,5	15,5	7,10
SPZ 250 06	TZ060250	6	250	254	5	2517	65	124	221	76	45		15,5	15,5	8,30
SPZ 280 06	TZ060280	6	280	284	5	2517	65	124	251	76	45		15,5	15,5	9,90
SPZ 315 06	TZ060315	6	315	319	5	2517	65	124	286	76	45		15,5	15,5	11,50
SPZ 355 06	TZ060355	6	355	359	5	2517	65	124	326	76	45		15,5	15,5	14,00
SPZ 400 06	TZ060400	6	400	404	5	3030	75	146	371	76	76				17,48
SPZ 450 06	TZ060450	6	450	454	5	3030	75	146	421	76	76				20,15
SPZ 500 06	TZ060500	6	500	504	5	3030	75	146	471	76	76				22,30
SPZ 630 06	TZ060630	6	630	634	4	3535	90	175	601	76	89		6,5	6,5	34,00
SPZ 800 06	TZ060800	6	800	804	4	3535	90	178	771	76	89		6,5	6,5	46,00



PULEGGE A GOLE TRAPEZOIDALI PER BUSSOLA CONICA V-BELTS PULLEYS FOR TAPER BUSH

SPZ - 8

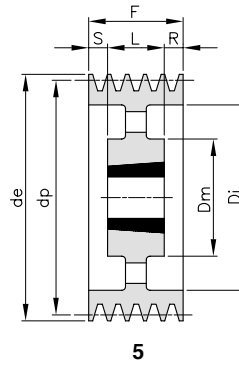
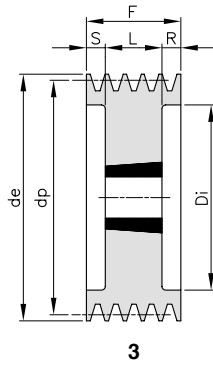

Materiale: GHISA EN-GJL-200

descrizione	codice	gole	dp	de	tipo	bussola	foro max	Dm	Di	E	F	L	R	S	Kg.
SPZ 140 08	TZ080140	8	140	144	3	2517	65		111		100	45	27,5	27,5	4,00
SPZ 150 08	TZ080150	8	150	154	3	2517	65		121		100	45	27,5	27,5	5,10
SPZ 160 08	TZ080160	8	160	164	3	2517	65		131		100	45	27,5	27,5	5,60
SPZ 180 08	TZ080180	8	180	184	3	2517	65		151		100	45	27,5	27,5	7,10
SPZ 190 08	TZ080190	8	190	194	3	3020	75		161		100	51	24,5	24,5	8,00
SPZ 200 08	TZ080200	8	200	204	3	3020	75		171		100	51	24,5	24,5	9,30
SPZ 224 08	TZ080224	8	224	228	3	3020	75		195		100	51	24,5	24,5	11,80
SPZ 250 08	TZ080250	8	250	254	5	3020	75	146	221		100	51	24,5	24,5	10,50
SPZ 280 08	TZ080280	8	280	284	5	3020	75	146	251		100	51	24,5	24,5	10,80
SPZ 355 08	TZ080355	8	355	359	5	3030	75	146	326		100	76	12	12	19,00
SPZ 400 08	TZ080400	8	400	404	5	3030	75	146	371		100	76	12	12	19,00
SPZ 450 08	TZ080450	8	450	454	5	3535	90	175	421		100	89	5,5	5,5	27,30
SPZ 500 08	TZ080500	8	500	504	5	3535	90	175	471		100	89	5,5	5,5	30,00



PULEGGE A GOLE TRAPEZOIDALI PER BUSSOLA CONICA V-BELTS PULLEYS FOR TAPER BUSH

SPA - 1

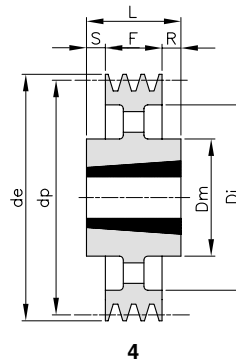
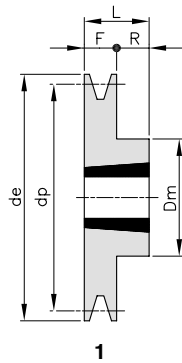

Materiale: GHISA EN-GJL-200

descrizione	codice	gole	dp	de	tipo	bussola	foro max	Dm	Di	E	F	L	R	S	Kg.
SPA 63 01	TA010063	1	63	68,5	1	1008	25	56			20	22	2		0,26
SPA 67 01	TA010067	1	67	72,5	1	1108	28	56			20	22	2		0,29
SPA 71 01	TA010071	1	71	76,5	1	1108	28	60			20	22	2		0,35
SPA 75 01	TA010075	1	75	80,5	1	1108	28	60			20	22	2		0,41
SPA 80 01	TA010080	1	80	85,5	1	1210	32	75			20	25	5		0,47
SPA 85 01	TA010085	1	85	90,5	1	1210	32	80			20	25	5		0,58
SPA 90 01	TA010090	1	90	95,5	1	1210	32	80			20	25	5		0,67
SPA 95 01	TA010095	1	95	100,5	1	1210	32	85			20	25	5		0,80
SPA 100 01	TA010100	1	100	105,5	1	1610	42	85			20	25	5		0,80
SPA 106 01	TA010106	1	106	111,5	1	1610	42	92			20	25	5		0,90
SPA 112 01	TA010112	1	112	117,5	1	1610	42	92			20	25	5		1,05
SPA 118 01	TA010118	1	118	123,5	1	1610	42	92			20	25	5		1,22
SPA 125 01	TA010125	1	125	130,5	1	1610	42	92			20	25	5		1,40
SPA 132 01	TA010132	1	132	137,5	1	1610	42	92			20	25	5		1,60
SPA 140 01	TA010140	1	140	145,5	1	1610	42	92			20	25	5		1,80
SPA 150 01	TA010150	1	150	155,5	1	1610	42	92			20	25	5		2,14
SPA 160 01	TA010160	1	160	165,5	1	1610	42	92			20	25	5		2,50
SPA 170 01	TA010170	1	170	175,5	1	1610	42	92			20	25	5		2,51
SPA 180 01	TA010180	1	180	185,5	4	1610	42	92	145		20	25	5		2,18
SPA 190 01	TA010190	1	190	195,5	4	1610	42	92	156		20	25	5		2,50
SPA 200 01	TA010200	1	200	205,5	4	2012	50	108	165		20	32	12		3,00
SPA 212 01	TA010212	1	212	217,5	4	2012	50	110	177		20	32	12		3,20
SPA 224 01	TA010224	1	224	229,5	4	2012	50	112	189		20	32	12		3,30
SPA 236 01	TA010236	1	236	241,5	4	2012	50	112	202		20	32	12		3,50
SPA 250 01	TA010250	1	250	255,5	4	2012	50	112	215		20	32	6	6	3,75
SPA 280 01	TA010280	1	280	285,5	4	2012	50	112	245		20	32	12		4,10
SPA 300 01	TA010300	1	300	305,5	4	2012	50	112	265		20	32	12		4,70
SPA 315 01	TA010315	1	315	320,5	4	2012	50	112	280		20	32	12		4,75
SPA 355 01	TA010355	1	355	360,5	4	2012	50	112	320		20	32	12		5,60
SPA 400 01	TA010400	1	400	405,5	4	2012	50	112	365		20	32	12		6,48
SPA 450 01	TA010450	1	450	455,5	4	2012	50	112	415		20	32	12		7,50
SPA 500 01	TA010500	1	500	505,5	4	2517	65	124	465		20	45	25		9,60
SPA 630 01	TA010630	1	630	635,5	4	2517	65	124	595		20	45	25		12,50



PULEGGE A GOLE TRAPEZOIDALI PER BUSSOLA CONICA V-BELTS PULLEYS FOR TAPER BUSH

SPA - 2

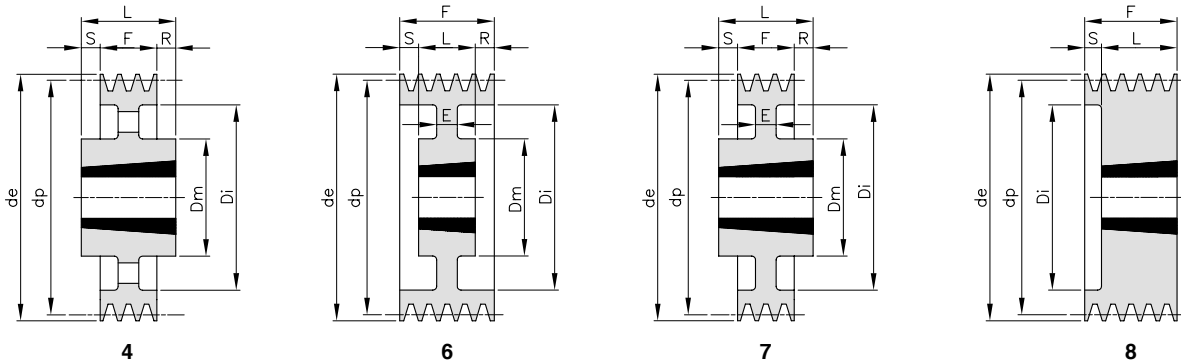

Materiale: GHISA EN-GJL-200 / *Materiale Acciaio

descrizione	codice	gole	dp	de	tipo	bussola	foro max	Dm	Di	E	F	L	R	S	Kg.
*SPA 63 02	TA020063	2	63	68,5	8	1008	25		32,5		35	22		13	0,43
SPA 67 02	TA020067	2	67	72,5	8	1108	28		37		35	22		13	0,45
SPA 71 02	TA020071	2	71	76,5	8	1108	28		40		35	22		13	0,51
SPA 75 02	TA020075	2	75	80,5	8	1108	28		44		35	22		13	0,59
SPA 80 02	TA020080	2	80	85,5	8	1210	32		50		35	25		10	0,60
SPA 85 02	TA020085	2	85	90,5	8	1210	32		55		35	25		10	0,70
SPA 90 02	TA020090	2	90	95,5	8	1610	42		59		35	25		10	0,70
SPA 95 02	TA020095	2	95	100,5	8	1610	42		63		35	25		10	0,85
SPA 100 02	TA020100	2	100	105,5	8	1610	42		66		35	25		10	1,00
SPA 106 02	TA020106	2	106	111,5	8	1610	42		72		35	25		10	1,17
SPA 112 02	TA020112	2	112	117,5	8	1610	42		78		35	25		10	1,37
SPA 118 02	TA020118	2	118	123,5	8	1610	42		84		35	25		10	1,56
SPA 125 02	TA020125	2	125	130,5	8	1610	42		91		35	25		10	1,85
SPA 132 02	TA020132	2	132	137,5	8	2012	50		98		35	32		3	2,08
SPA 140 02	TA020140	2	140	145,5	8	2012	50		106		35	32		3	2,45
SPA 150 02	TA020150	2	150	155,5	8	2012	50		116		35	32		3	2,95
SPA 160 02	TA020160	2	160	165,5	8	2012	50		125		35	32		3	3,50
SPA 170 02	TA020170	2	170	175,5	8	2012	50		135		35	32		3	4,10
SPA 180 02	TA020180	2	180	185,5	6	2012	50	108	146	10	35	32	1,5	1,5	3,53
SPA 190 02	TA020190	2	190	195,5	6	2012	50	108	156	10	35	32	1,5	1,5	3,82
SPA 200 02	TA020200	2	200	205,5	7	2517	65	123	163	10	35	45	5	5	4,73
SPA 212 02	TA020212	2	212	217,5	4	2517	65	123	177		35	45	5	5	4,98
SPA 224 02	TA020224	2	224	229,5	4	2517	65	124	189		35	45	10		5,20
SPA 236 02	TA020236	2	236	241,5	4	2517	65	124	202		35	45	10		5,37
SPA 250 02	TA020250	2	250	255,5	4	2517	65	124	215		35	45	5	5	5,77
SPA 280 02	TA020280	2	280	285,5	4	2517	65	124	245		35	45	10		6,52
SPA 300 02	TA020300	2	300	305,5	4	2517	65	124	265		35	45	10		7,00
SPA 315 02	TA020315	2	315	320,5	4	2517	65	124	280		35	45	10		7,14
SPA 355 02	TA020355	2	355	360,5	4	2517	65	124	320		35	45	10		8,70
SPA 400 02	TA020400	2	400	405,5	4	2517	65	124	365		35	45	10		10,20
SPA 450 02	TA020450	2	450	455,5	4	2517	65	124	415		35	45	10		11,54
SPA 500 02	TA020500	2	500	505,5	4	2517	65	124	465		35	45	10		18,98
SPA 630 02	TA020630	2	630	635,5	4	3020	75	159	595		35	51	8	8	19,50



PULEGGE A GOLE TRAPEZOIDALI PER BUSSOLA CONICA V-BELTS PULLEYS FOR TAPER BUSH

SPA - 3

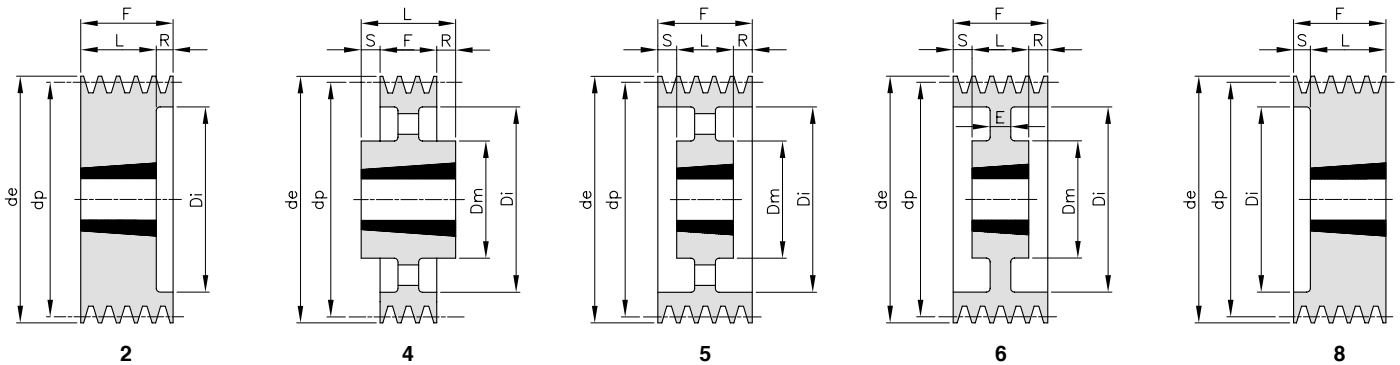

Materiale: GHISA EN-GJL-200

descrizione	codice	gole	dp	de	tipo	bussola	foro max	Dm	Di	E	F	L	R	S	Kg.
SPA 71 03	TA030071	3	71	76,5	8	1108	28		40		50	22		28	0,70
SPA 75 03	TA030075	3	75	80,5	8	1108	28		44		50	22		28	0,80
SPA 80 03	TA030080	3	80	85,5	8	1210	32		50		50	25		25	0,80
SPA 85 03	TA030085	3	85	90,5	8	1210	32		55		50	25		25	0,93
SPA 90 03	TA030090	3	90	95,5	8	1610	42		59		50	25		25	0,94
SPA 95 03	TA030095	3	95	100,5	8	1610	42		63		50	25		25	1,13
SPA 100 03	TA030100	3	100	105,5	2	1610	42		66		50	25	25		1,32
SPA 106 03	TA030106	3	106	111,5	2	1610	42		72		50	25	25		1,52
SPA 112 03	TA030112	3	112	117,5	8	2012	50		78		50	32		18	1,57
SPA 118 03	TA030118	3	118	123,5	2	2012	50		84		50	32	18		1,83
SPA 125 03	TA030125	3	125	130,5	2	2012	50		91		50	32	18		2,20
SPA 132 03	TA030132	3	132	137,5	2	2012	50		98		50	32	18		2,54
SPA 140 03	TA030140	3	140	145,5	8	2517	65		106		50	45		5	2,85
SPA 150 03	TA030150	3	150	155,5	8	2517	65		116		50	45		5	3,57
SPA 160 03	TA030160	3	160	165,5	8	2517	65		125		50	45		5	4,33
SPA 170 03	TA030170	3	170	175,5	8	2517	65		135		50	45		5	5,13
SPA 180 03	TA030180	3	180	185,5	8	2517	65		146		50	45		5	6,00
SPA 190 03	TA030190	3	190	195,5	8	2517	65		156		50	45		5	6,80
SPA 200 03	TA030200	3	200	205,5	6	2517	65	123	165	20	50	45	2,5	2,5	6,17
SPA 212 03	TA030212	3	212	217,5	5	2517	65	123	177		50	45	2,5	2,5	6,00
SPA 224 03	TA030224	3	224	229,5	5	2517	65	124	189		50	45	2,5	2,5	6,42
SPA 236 03	TA030236	3	236	241,5	5	2517	65	124	202		50	45	2,5	2,5	6,67
SPA 250 03	TA030250	3	250	255,5	5	2517	65	124	215		50	45	2,5	2,5	7,08
SPA 280 03	TA030280	3	280	285,5	5	2517	65	124	245		50	45	2,5	2,5	8,18
SPA 300 03	TA030300	3	300	305,5	4	3020	75	159	265		50	51	0,5	0,5	10,00
SPA 315 03	TA030315	3	315	320,5	4	3020	75	159	280		50	51	0,5	0,5	11,10
SPA 355 03	TA030355	3	355	360,5	4	3020	75	159	320		50	51	0,5	0,5	12,50
SPA 400 03	TA030400	3	400	405,5	4	3020	75	159	365		50	51	1		14,45
SPA 450 03	TA030450	3	450	455,5	4	3020	75	159	415		50	51	1		16,88
SPA 500 03	TA030500	3	500	505,5	4	3020	75	159	465		50	51	1		19,50
SPA 560 03	TA030560	3	560	565,5	4	3020	75	159	525		50	51	1		20,70
SPA 630 03	TA030630	3	630	635,5	4	3020	75	159	595		50	51	1		23,70
SPA 800 03	TA030800	3	800	805,5	4	3535	90	175	765		50	89	19,5	19,5	39,00
SPA1000 03	TA031000	3	1000	1005,5	4	3535	90	175	965		50	89	19,5	19,5	49,00



PULEGGE A GOLE TRAPEZOIDALI PER BUSSOLA CONICA V-BELTS PULLEYS FOR TAPER BUSH

SPA - 4

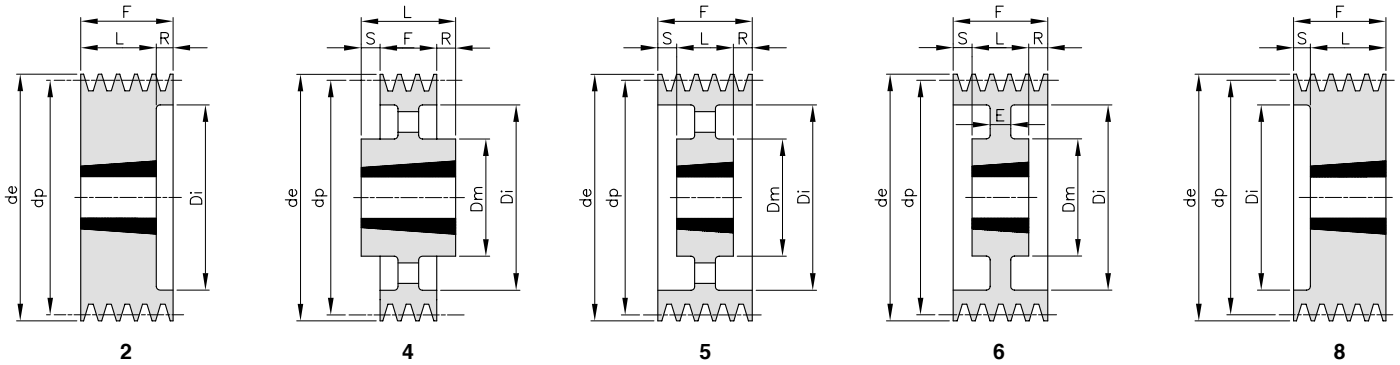

Materiale: GHISA EN-GJL-200

descrizione	codice	gole	dp	de	tipo	bussola	foro max	Dm	Di	E	F	L	R	S	Kg.
SPA 90 04	TA040090	4	90	95,5	8	1615	42		59		65	38		27	1,26
SPA 95 04	TA040095	4	95	100,5	8	1615	42		63		65	38		27	1,48
SPA 100 04	TA040100	4	100	105,5	2	1615	42		66		65	38	27		1,76
SPA 106 04	TA040106	4	106	111,5	8	2012	50		72		65	32		33	1,66
SPA 112 04	TA040112	4	112	117,5	8	2012	50		78		65	32		33	1,92
SPA 118 04	TA040118	4	118	123,5	2	2012	50		84		65	32	33		2,22
SPA 125 04	TA040125	4	125	130,5	2	2012	50		91		65	32	33		2,65
SPA 132 04	TA040132	4	132	137,5	2	2517	65		98		65	45	20		2,80
SPA 140 04	TA040140	4	140	145,5	2	2517	65		106		65	45	20		3,36
SPA 150 04	TA040150	4	150	155,5	2	2517	65		116		65	45	20		4,11
SPA 160 04	TA040160	4	160	165,5	2	2517	65		125		65	45	20		4,92
SPA 170 04	TA040170	4	170	175,5	2	2517	65		135		65	45	20		5,75
SPA 180 04	TA040180	4	180	185,5	2	2517	65		146		65	45	20		6,64
SPA 190 04	TA040190	4	190	195,5	2	2517	65		156		65	45	20		7,62
SPA 200 04	TA040200	4	200	205,5	2	3020	75		165		65	51	14		8,12
SPA 212 04	TA040212	4	212	217,5	2	3020	75		177		65	51	14		9,58
SPA 224 04	TA040224	4	224	229,5	2	3020	75		189		65	51	14		11,10
SPA 236 04	TA040236	4	236	241,5	6	3020	75	159	202	20	65	51	14		9,90
SPA 250 04	TA040250	4	250	255,5	5	3020	75	159	215		65	51	7	7	10,13
SPA 280 04	TA040280	4	280	285,5	5	3020	75	159	245		65	51	7	7	11,22
SPA 300 04	TA040300	4	300	305,5	5	3020	75	159	265		65	51	7	7	12,20
SPA 315 04	TA040315	4	315	320,5	5	3020	75	159	280		65	51	7	7	13,00
SPA 355 04	TA040355	4	355	360,5	5	3020	75	159	320		65	51	7	7	14,60
SPA 400 04	TA040400	4	400	405,5	5	3020	75	159	365		65	51	7	7	17,10
SPA 450 04	TA040450	4	450	455,5	5	3020	75	159	415		65	51	7	7	19,70
SPA 500 04	TA040500	4	500	505,5	5	3020	75	159	465		65	51	7	7	21,70
SPA 560 04	TA040560	4	560	565,5	4	3535	90	175	525		65	89	12	12	28,00
SPA 630 04	TA040630	4	630	635,5	4	3535	90	175	595		65	89	12	12	33,00
SPA 800 04	TA040800	4	800	805,5	4	3535	90	175	765		65	89	12	12	45,00
SPA1000 04	TA041000	4	1000	1005,5	4	4040	100	210	965		65	102	18,5	18,5	64,00



PULEGGE A GOLE TRAPEZOIDALI PER BUSSOLA CONICA V-BELTS PULLEYS FOR TAPER BUSH

SPA - 5

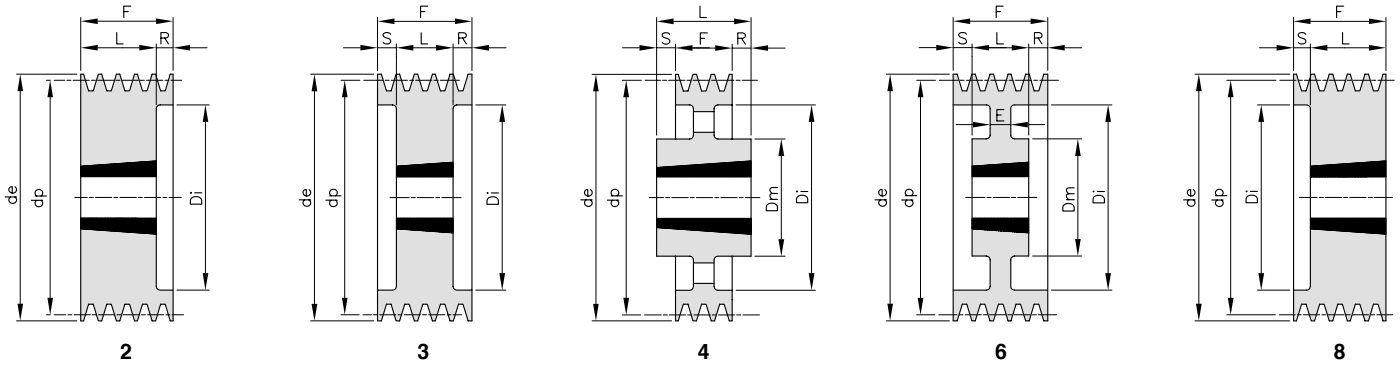

Materiale: GHISA EN-GJL-200

descrizione	codice	gole	dp	de	tipo	bussola	foro max	Dm	Di	E	F	L	R	S	Kg.
SPA 100 05	TA050100	5	100	105,5	2	1615	42		66		80	38	42		2,10
SPA 106 05	TA050106	5	106	111,5	8	2012	50		72		80	32		48	2,30
SPA 112 05	TA050112	5	112	117,5	8	2012	50		78		80	32		48	2,50
SPA 118 05	TA050118	5	118	123,5	2	2012	50		84		80	32	48		2,80
SPA 125 05	TA050125	5	125	130,5	3	2012	50		91		80	32	24	24	3,00
SPA 132 05	TA050132	5	132	137,5	3	2517	65		98		80	45	17,5	17,5	3,50
SPA 140 05	TA050140	5	140	145,5	3	2517	65		106		80	45	17,5	17,5	3,90
SPA 150 05	TA050150	5	150	155,5	3	2517	65		116		80	45	17,5	17,5	4,40
SPA 160 05	TA050160	5	160	165,5	3	2517	65		125		80	45	17,5	17,5	5,70
SPA 170 05	TA050170	5	170	175,5	3	2517	65		135		80	45	17,5	17,5	6,30
SPA 180 05	TA050180	5	180	185,5	3	3020	75		146		80	51	14,5	14,5	6,90
SPA 190 05	TA050190	5	190	195,5	2	3020	75		156		80	51	29		7,70
SPA 200 05	TA050200	5	200	205,5	3	3020	75		168		80	51	14,5	14,5	9,00
SPA 212 05	TA050212	5	212	217,5	2	3020	75		177		80	51	29		9,80
SPA 224 05	TA050224	5	224	229,5	2	3020	75		189		80	51	29		10,20
SPA 236 05	TA050236	5	236	241,5	2	3020	75		202		80	51	29		11,20
SPA 250 05	TA050250	5	250	255,5	6	3020	75	159	215	20	80	51	14,5	14,5	12,40
SPA 280 05	TA050280	5	280	285,5	4	3535	90	175	245		80	89	4,5	4,5	15,00
SPA 300 05	TA050300	5	300	305,5	4	3535	90	175	265		80	89	4,5	4,5	16,50
SPA 315 05	TA050315	5	315	320,5	4	3535	90	175	280		80	89	4,5	4,5	18,10
SPA 355 05	TA050355	5	355	360,5	4	3535	90	175	320		80	89	4,5	4,5	19,70
SPA 400 05	TA050400	5	400	405,5	4	3535	90	175	365		80	89	4,5	4,5	22,50
SPA 450 05	TA050450	5	450	455,5	4	3535	90	175	415		80	89	4,5	4,5	25,20
SPA 500 05	TA050500	5	500	505,5	4	3535	90	175	465		80	89	4,5	4,5	29,60
SPA 560 05	TA050560	5	560	565,5	4	3535	90	175	525		80	89	4,5	4,5	32,00
SPA 630 05	TA050630	5	630	635,5	4	3535	90	175	595		80	89	4,5	4,5	36,00
SPA 800 05	TA050800	5	800	805,5	4	4040	100	210	765		80	102	11	11	50,00
SPA1000 05	TA051000	5	1000	1005,5	4	4545	110	242	965		80	114	17	17	77,00



PULEGGE A GOLE TRAPEZOIDALI PER BUSSOLA CONICA V-BELTS PULLEYS FOR TAPER BUSH

SPA - 6

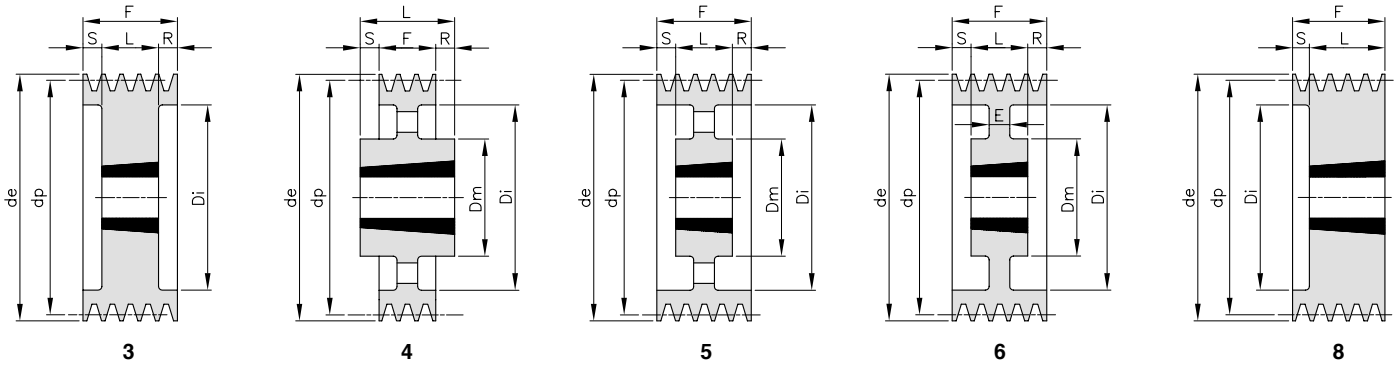

Materiale: GHISA EN-GJL-200

descrizione	codice	gole	dp	de	tipo	bussola	foro max	Dm	Di	E	F	L	R	S	Kg.
SPA 100 06	TA060100	6	100	105,5	3	1610	42		66		95	25	40	30	2,50
SPA 106 06	TA060106	6	106	111,5	8	2012	50		72		95	32		63	2,60
SPA 112 06	TA060112	6	112	117,5	8	2012	50		78		95	32		63	2,90
SPA 118 06	TA060118	6	118	123,5	8	2012	50		84		95	32		63	3,30
SPA 125 06	TA060125	6	125	130,5	3	2012	50		91		95	32	31,5	31,5	3,50
SPA 132 06	TA060132	6	132	137,5	3	2517	65		98		95	45	25	25	3,80
SPA 140 06	TA060140	6	140	145,5	3	2517	65		106		95	45	25	25	4,10
SPA 150 06	TA060150	6	150	155,5	3	2517	65		116		95	45	25	25	4,90
SPA 160 06	TA060160	6	160	165,5	3	2517	65		125		95	45	25	25	5,70
SPA 180 06	TA060180	6	180	185,5	3	3020	75		146		95	51	22	22	8,50
SPA 200 06	TA060200	6	200	205,5	3	3020	75		165		95	51	22	22	11,00
SPA 224 06	TA060224	6	224	229,5	3	3020	75		189		95	51	22	22	13,40
SPA 236 06	TA060236	6	236	241,5	3	3020	75		202		95	51	22	22	14,90
SPA 250 06	TA060250	6	250	255,5	6	3020	75	155	215	20	95	51	22	22	16,40
SPA 280 06	TA060280	6	280	285,5	5	3535	90	175	245		95	89	3	3	17,30
SPA 315 06	TA060315	6	315	320,5	5	3535	90	175	280		95	89	3	3	21,70
SPA 355 06	TA060355	6	355	360,5	5	3535	90	175	320		95	89	3	3	22,00
SPA 400 06	TA060400	6	400	405,5	5	3535	90	175	365		95	89	3	3	24,60
SPA 450 06	TA060450	6	450	455,5	5	3535	90	175	415		95	89	3	3	27,40
SPA 500 06	TA060500	6	500	505,5	5	3535	90	175	465		95	89	3	3	30,00
SPA 560 06	TA060560	6	560	565,5	5	3535	90	175	525		95	89	3	3	33,00
SPA 630 06	TA060630	6	630	635,5	4	4040	100	210	595		95	102	3,5	3,5	46,50
SPA 800 06	TA060800	6	800	805,5	4	4040	100	210	765		95	102	3,5	3,5	59,00
SPA1000 06	TA061000	6	1000	1005,5	4	4545	110	242	965		95	114	9,5	9,5	87,00



PULEGGE A GOLE TRAPEZOIDALI PER BUSSOLA CONICA V-BELTS PULLEYS FOR TAPER BUSH

SPB - 1

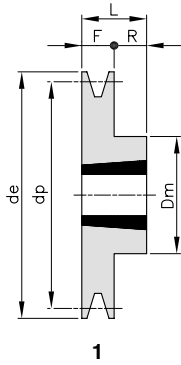

1

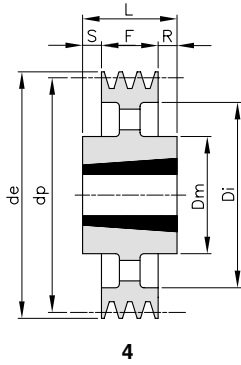

4

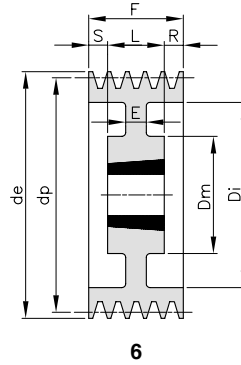

6

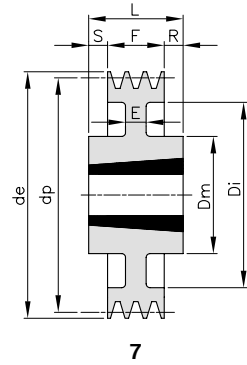

7

Materiale: GHISA EN-GJL-200

descrizione	codice	gole	dp	de	tipo	bussola	foro max	Dm	Di	E	F	L	R	S	Kg.
SPB 100 01	TB010100	1	100	107	1	1610	42				25	25			0,90
SPB 106 01	TB010106	1	106	113	1	1610	42				25	25			1,00
SPB 112 01	TB010112	1	112	119	1	1610	42				25	25			1,20
SPB 118 01	TB010118	1	118	125	1	1610	42				25	25			1,30
SPB 125 01	TB010125	1	125	132	1	1610	42				25	25			1,50
SPB 132 01	TB010132	1	132	139	1	1610	42				25	25			1,70
SPB 140 01	TB010140	1	140	147	1	1610	42				25	25			1,80
SPB 150 01	TB010150	1	150	157	1	1610	42				25	25			2,10
SPB 160 01	TB010160	1	160	167	1	1610	42				25	25			2,50
SPB 170 01	TB010170	1	170	177	1	1610	42				25	25			2,90
SPB 180 01	TB010180	1	180	187	6	1610	42	90	132	12	25	25			3,20
SPB 190 01	TB010190	1	190	197	7	2012	50	104	147	12	25	32	3,5	3,5	3,80
SPB 200 01	TB010200	1	200	207	4	2012	50	104	157		25	32	3,5	3,5	4,20
SPB 212 01	TB010212	1	212	219	4	2012	50	104	169		25	32	3,5	3,5	4,40
SPB 224 01	TB010224	1	224	231	4	2012	50	104	181		25	32	3,5	3,5	4,70
SPB 236 01	TB010236	1	236	243	4	2012	50	104	193		25	32	3,5	3,5	4,60
SPB 250 01	TB010250	1	250	257	4	2012	50	104	207		25	32	3,5	3,5	5,30
SPB 280 01	TB010280	1	280	287	4	2012	50	104	237		25	32	3,5	3,5	6,00
SPB 300 01	TB010300	1	300	307	4	2012	50	104	258		25	32	3,5	3,5	6,50
SPB 315 01	TB010315	1	315	322	4	2012	50	104	272		25	32	3,5	3,5	7,00



PULEGGE A GOLE TRAPEZOIDALI PER BUSSOLA CONICA V-BELTS PULLEYS FOR TAPER BUSH

SPB - 2

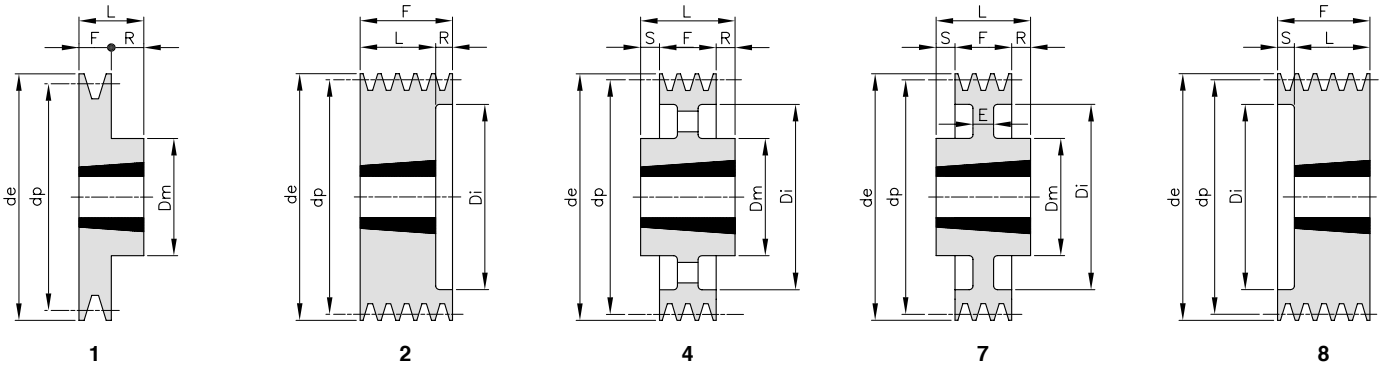

Materiale: GHISA EN-GJL-200

descrizione	codice	gole	dp	de	tipo	bussola	foro max	Dm	Di	E	F	L	R	S	Kg.
SPB 95 02	TB020095	2	95	102	8	1610	42		57		44	25		19	1,22
SPB 100 02	TB020100	2	100	107	8	1610	42		62		44	25		19	1,40
SPB 106 02	TB020106	2	106	113	8	1610	42		67		44	25		19	1,60
SPB 112 02	TB020112	2	112	119	8	1610	42		72		44	25		19	1,70
SPB 118 02	TB020118	2	118	125	2	1610	42		78		44	25	19		1,80
SPB 125 02	TB020125	2	125	132	2	2012	50		82		44	32	12		1,90
SPB 132 02	TB020132	2	132	139	2	2012	50		89		44	32	12		2,50
SPB 140 02	TB020140	2	140	147	2	2012	50		97		44	32	12		2,70
SPB 150 02	TB020150	2	150	157	2	2012	50		107		44	32	12		3,20
SPB 160 02	TB020160	2	160	167	2	2012	50		117		44	32	12		3,80
SPB 170 02	TB020170	2	170	177	2	2012	50		127		44	32	12		4,80
SPB 180 02	TB020180	2	180	187	1	2517	65	120			44	45	1		6,30
SPB 190 02	TB020190	2	190	197	1	2517	65	120			44	45	1		7,20
SPB 200 02	TB020200	2	200	207	1	2517	65	117			44	45	1		8,20
SPB 212 02	TB020212	2	212	219	7	2517	65	117	169	15	44	45	1		5,40
SPB 224 02	TB020224	2	224	231	4	2517	65	117	181		44	45	1		5,90
SPB 236 02	TB020236	2	236	243	4	2517	65	117	193		44	45	1		6,60
SPB 250 02	TB020250	2	250	257	4	2517	65	125	207		44	45	1		7,10
SPB 265 02	TB020265	2	265	272	4	2517	65	125	222		44	45	1		7,20
SPB 280 02	TB020280	2	280	287	4	2517	65	125	237		44	45	1		7,40
SPB 300 02	TB020300	2	300	307	4	2517	65	125	257		44	45	1		8,60
SPB 315 02	TB020315	2	315	322	4	2517	65	125	272		44	45	1		9,90
SPB 335 02	TB020335	2	335	342	4	2517	65	125	292		44	45	1		11,30
SPB 355 02	TB020355	2	355	362	4	3020	75	144	312		44	51	3,5	3,5	12,00
SPB 400 02	TB020400	2	400	407	4	3020	75	150	357		44	51	3,5	3,5	13,00
SPB 450 02	TB020450	2	450	457	4	3020	75	150	407		44	51	3,5	3,5	13,50
SPB 500 02	TB020500	2	500	507	4	3020	75	150	457		44	51	3,5	3,5	15,00
SPB 560 02	TB020560	2	560	567	4	3030	75	150	517		44	76	28	4	20,15
SPB 630 02	TB020630	2	630	637	4	3030	75	150	587		44	76	16	16	24,50



PULEGGE A GOLE TRAPEZOIDALI PER BUSSOLA CONICA V-BELTS PULLEYS FOR TAPER BUSH

SPB - 3

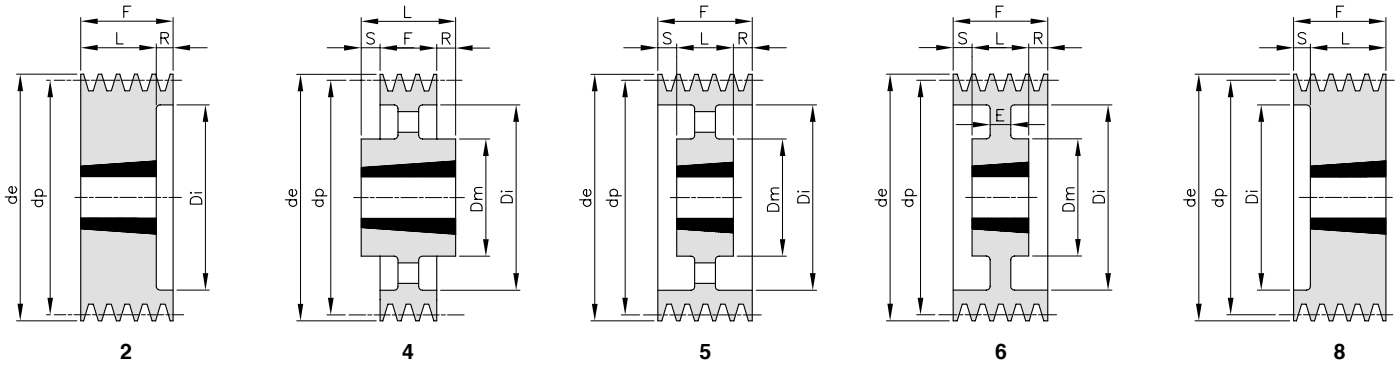

Materiale: GHISA EN-GJL-200

descrizione	codice	gole	dp	de	tipo	bussola	foro max	Dm	Di	E	F	L	R	S	Kg.
SPB 95 03	TB030095	3	95	102	8	1610	42		57		63	25		38	1,44
SPB 100 03	TB030100	3	100	107	8	1610	42		62		63	25		38	1,90
SPB 106 03	TB030106	3	106	113	8	1610	42		67		63	25		38	2,20
SPB 112 03	TB030112	3	112	119	8	1610	42		72		63	25		38	2,40
SPB 118 03	TB030118	3	118	125	2	1610	42		78		63	25	38		2,60
SPB 125 03	TB030125	3	125	132	2	2012	50		82		63	32	31		3,20
SPB 132 03	TB030132	3	132	139	2	2012	50		89		63	32	31		3,20
SPB 140 03	TB030140	3	140	147	2	2012	50		97		63	32	31		3,60
SPB 150 03	TB030150	3	150	157	2	2517	65		107		63	45	18		4,00
SPB 160 03	TB030160	3	160	167	2	2517	65		117		63	45	18		4,50
SPB 170 03	TB030170	3	170	177	2	2517	65		127		63	45	18		5,57
SPB 180 03	TB030180	3	180	187	2	2517	65		137		63	45	18		5,90
SPB 190 03	TB030190	3	190	197	2	2517	65		147		63	45	18		6,50
SPB 200 03	TB030200	3	200	207	2	2517	65		157		63	45	18		6,70
SPB 212 03	TB030212	3	212	219	6	2517	65	117	169	15	63	45	18		6,90
SPB 224 03	TB030224	3	224	231	5	2517	65	117	181		63	45	18		7,50
SPB 236 03	TB030236	3	236	243	5	2517	65	117	193		63	45	18		8,80
SPB 250 03	TB030250	3	250	257	5	3020	75	144	207		63	51	12		10,20
SPB 265 03	TB030265	3	265	272	5	3020	75	144	222		63	51	6	6	10,80
SPB 280 03	TB030280	3	280	287	5	3020	75	144	237		63	51	6	6	11,30
SPB 300 03	TB030300	3	300	307	5	3020	75	144	257		63	51	6	6	12,30
SPB 315 03	TB030315	3	315	322	5	3020	75	144	272		63	51	6	6	13,50
SPB 335 03	TB030335	3	335	342	5	3020	75	144	292		63	51	6	6	14,70
SPB 355 03	TB030355	3	355	362	5	3020	75	144	312		63	51	6	6	14,00
SPB 400 03	TB030400	3	400	407	4	3535	90	175	357		63	89	13	13	20,80
SPB 450 03	TB030450	3	450	457	4	3535	90	175	407		63	89	26		24,00
SPB 500 03	TB030500	3	500	507	4	3535	90	175	457		63	89	26		24,00
SPB 560 03	TB030560	3	560	567	4	3535	90	175	517		63	89	26		30,00
SPB 630 03	TB030630	3	630	637	4	3535	90	175	587		63	89	26		33,50
SPB 710 03	TB030710	3	710	717	4	3535	90	175	664		63	89	13	13	43,00
SPB 800 03	TB030800	3	800	807	4	3535	90	175	754		63	89	13	13	49,00
SPB 900 03	TB030900	3	900	907	4	3535	90	175	854		63	89	13	13	55,00
SPB1000 03	TB031000	3	1000	1007	4	4040	100	210	954		63	102	19,5	19,5	76,00
SPB1250 03	TB031250	3	1250	1257	4	4040	100	210	1204		63	102	19,5	19,5	102,00



PULEGGE A GOLE TRAPEZOIDALI PER BUSSOLA CONICA V-BELTS PULLEYS FOR TAPER BUSH

SPB - 4

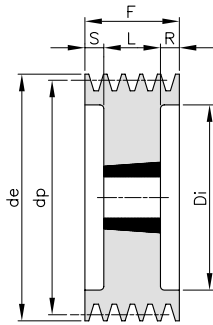

3

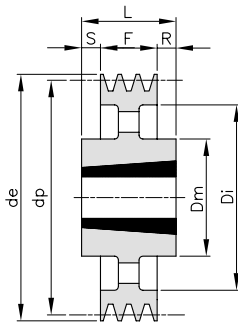

4

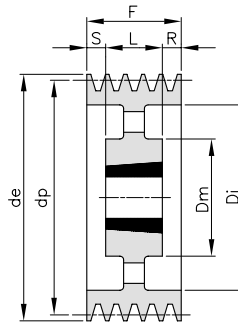

5

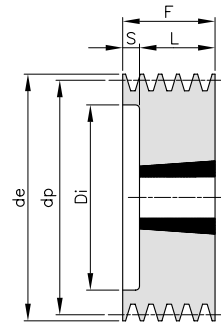

8

Materiale: GHISA EN-GJL-200

descrizione	codice	gole	dp	de	tipo	bussola	foro max	Dm	Di	E	F	L	R	S	Kg.
SPB 118 04	TB040118	4	118	125	8	1610	42		78	82	25			57	4,00
SPB 125 04	TB040125	4	125	132	3	2012	50		82	82	32	25	25	25	3,50
SPB 132 04	TB040132	4	132	139	3	2012	50		89	82	32	25	25	25	3,70
SPB 140 04	TB040140	4	140	147	3	2517	65		100	82	45	18,5	18,5	18,5	4,30
SPB 150 04	TB040150	4	150	157	3	2517	65		107	82	45	18,5	18,5	18,5	4,60
SPB 160 04	TB040160	4	160	167	3	2517	65		117	82	45	18,5	18,5	18,5	5,20
SPB 170 04	TB040170	4	170	177	3	2517	65		127	82	45	18,5	18,5	18,5	6,10
SPB 180 04	TB040180	4	180	187	3	2517	65		137	82	45	18,5	18,5	18,5	7,20
SPB 190 04	TB040190	4	190	197	3	2517	65		147	82	45	18,5	18,5	18,5	7,90
SPB 200 04	TB040200	4	200	207	3	3020	75		157	82	51	15,5	15,5	15,5	9,08
SPB 212 04	TB040212	4	212	219	3	3020	75		169	82	51	15,5	15,5	15,5	10,00
SPB 224 04	TB040224	4	224	231	3	3020	75		181	82	51	15,5	15,5	15,5	11,50
SPB 236 04	TB040236	4	236	243	3	3020	75		193	82	51	15,5	15,5	15,5	12,80
SPB 250 04	TB040250	4	250	257	5	3020	75	144	207	82	51	15,5	15,5	15,5	13,50
SPB 265 04	TB040265	4	265	272	5	3020	75	144	222	82	51	15,5	15,5	15,5	13,80
SPB 280 04	TB040280	4	280	287	5	3020	75	144	237	82	51	15,5	15,5	15,5	14,10
SPB 300 04	TB040300	4	300	307	4	3535	90	175	257	82	89	7			15,80
SPB 315 04	TB040315	4	315	322	4	3535	90	175	272	82	89	3,5	3,5	3,5	19,00
SPB 335 04	TB040335	4	335	342	4	3535	90	175	292	82	89	3,5	3,5	3,5	20,70
SPB 355 04	TB040355	4	355	362	4	3535	90	175	312	82	89	3,5	3,5	3,5	21,40
SPB 400 04	TB040400	4	400	407	4	3535	90	175	357	82	89	3,5	3,5	3,5	24,30
SPB 450 04	TB040450	4	450	457	4	3535	90	175	407	82	89	7			27,40
SPB 500 04	TB040500	4	500	507	4	3535	90	175	457	82	89	7			31,00
SPB 560 04	TB040560	4	560	567	4	3535	90	175	517	82	89	7			36,00
SPB 630 04	TB040630	4	630	637	4	3535	90	175	587	82	89	7			41,00
SPB 710 04	TB040710	4	710	717	4	3535	90	175	664	82	89	3,5	3,5	3,5	49,00
SPB 800 04	TB040800	4	800	807	4	4040	100	210	754	82	102	10	10	10	63,00
SPB 900 04	TB040900	4	900	907	4	4040	100	210	854	82	102	10	10	10	75,00
SPB1000 04	TB041000	4	1000	1007	4	4040	100	210	954	82	102	16	10	10	86,00
SPB1250 04	TB041250	4	1250	1257	4	4545	110	242	1204	82	114	16	16	16	118,00



PULEGGE A GOLE TRAPEZOIDALI PER BUSSOLA CONICA V-BELTS PULLEYS FOR TAPER BUSH

SPB - 5

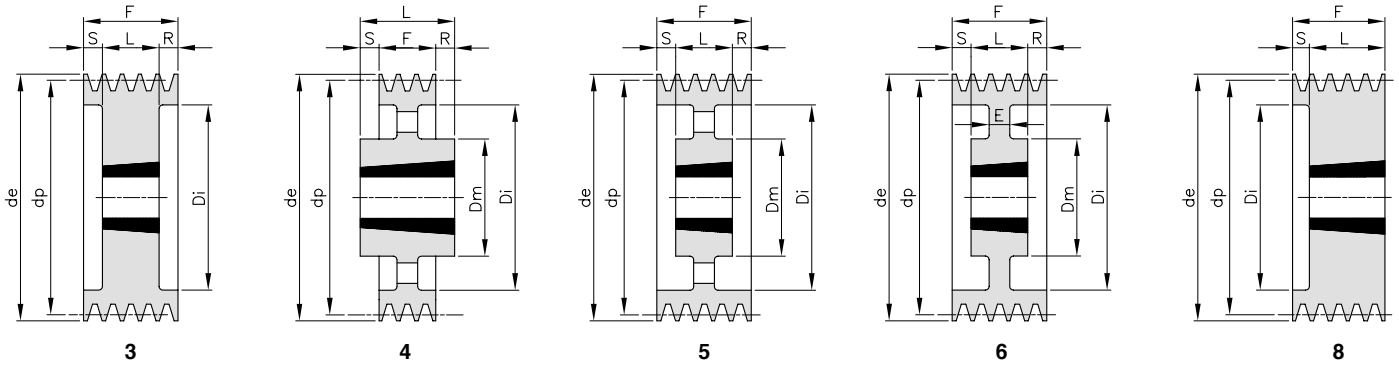

Materiale: GHISA EN-GJL-200

descrizione	codice	gole	dp	de	tipo	bussola	foro max	Dm	Di	E	F	L	R	S	Kg.
SPB 125 05	TB050125	5	125	132	8	2012	50		87		101	32		69	3,55
SPB 132 05	TB050132	5	132	139	8	2517	65		94		101	45		56	3,67
SPB 140 05	TB050140	5	140	147	3	2517	65		97		101	45	28	28	4,63
SPB 150 05	TB050150	5	150	157	3	2517	65		107		101	45	28	28	5,50
SPB 160 05	TB050160	5	160	167	3	2517	65		117		101	45	28	28	6,40
SPB 170 05	TB050170	5	170	177	3	3020	75		127		101	51	25	25	6,50
SPB 180 05	TB050180	5	180	187	3	3020	75		137		101	51	25	25	7,70
SPB 190 05	TB050190	5	190	197	3	3020	75		147		101	51	25	25	8,70
SPB 200 05	TB050200	5	200	207	3	3020	75		157		101	51	25	25	10,20
SPB 212 05	TB050212	5	212	219	3	3020	75		169		101	51	25	25	11,70
SPB 224 05	TB050224	5	224	231	3	3020	75		181		101	51	25	25	13,00
SPB 236 05	TB050236	5	236	243	3	3535	90		193		101	89	6	6	18,50
SPB 250 05	TB050250	5	250	257	3	3535	90		207		101	89	6	6	21,90
SPB 265 05	TB050265	5	265	272	6	3535	90	175	222	30	101	89	6	6	21,20
SPB 280 05	TB050280	5	280	287	6	3535	90	175	237	25	101	89	6	6	20,50
SPB 300 05	TB050300	5	300	307	6	3535	90	175	257	25	101	89	6	6	22,70
SPB 315 05	TB050315	5	315	322	5	3535	90	175	272		101	89	6	6	21,10
SPB 335 05	TB050335	5	335	342	5	3535	90	175	292		101	89	6	6	22,60
SPB 355 05	TB050355	5	355	362	4	3535	90	175	312		101	89	6	6	24,00
SPB 400 05	TB050400	5	400	407	4	3535	90	175	357		101	89	6	6	27,00
SPB 450 05	TB050450	5	450	457	4	3535	90	175	407		101	89	12		32,00
SPB 500 05	TB050500	5	500	507	4	3535	90	175	457		101	89	12		34,00
SPB 560 05	TB050560	5	560	567	4	4040	100	210	517		101	102	1		44,00
SPB 630 05	TB050630	5	630	637	4	4040	100	210	587		101	102	1		59,00
SPB 710 05	TB050710	5	710	717	4	4040	100	210	664		101	102	1		61,00
SPB 800 05	TB050800	5	800	807	4	4040	100	210	754		101	102	1		70,00
SPB 900 05	TB050900	5	900	907	4	4040	100	210	854		101	102	1		76,00
SPB1000 05	TB051000	5	1000	1007	4	4545	110	242	954		101	114	6,5	6,5	104,00
SPB1250 05	TB051250	5	1250	1257	4	4545	110	242	1204		101	114	6,5	6,5	127,00



PULEGGE A GOLE TRAPEZOIDALI PER BUSSOLA CONICA V-BELTS PULLEYS FOR TAPER BUSH

SPB - 6

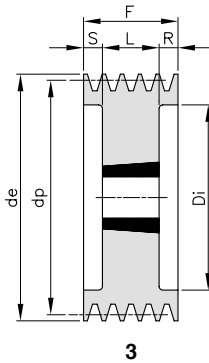

3

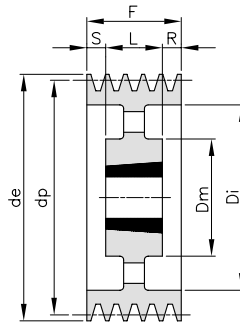

5

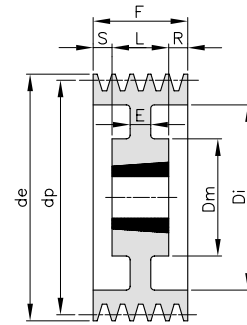

6

Materiale: GHISA EN-GJL-200

descrizione	codice	gole	dp	de	tipo	bussola	foro max	Dm	Di	E	F	L	R	S	Kg.
SPB 140 06	TB060140	6	140	147	3	2517	65		100		120	45	37,5	37,5	5,40
SPB 150 06	TB060150	6	150	157	3	2517	65		107		120	45	37,5	37,5	6,20
SPB 160 06	TB060160	6	160	167	3	3020	75		118		120	51	34,5	34,5	5,80
SPB 170 06	TB060170	6	170	177	3	3020	75		127		120	51	34,5	34,5	7,40
SPB 180 06	TB060180	6	180	187	3	3020	75		137		120	51	34,5	34,5	8,70
SPB 190 06	TB060190	6	190	197	3	3020	75		147		120	51	34,5	34,5	9,40
SPB 200 06	TB060200	6	200	207	3	3020	75		157		120	51	34,5	34,5	11,00
SPB 212 06	TB060212	6	212	219	3	3535	90		169		120	89	15,5	15,5	14,50
SPB 224 06	TB060224	6	224	231	3	3535	90		181		120	89	15,5	15,5	17,00
SPB 236 06	TB060236	6	236	243	3	3535	90		193		120	89	15,5	15,5	20,00
SPB 250 06	TB060250	6	250	257	3	3535	90		207		120	89	15,5	15,5	23,50
SPB 265 06	TB060265	6	265	272	6	3535	90	175	222	30	120	89	15,5	15,5	23,30
SPB 280 06	TB060280	6	280	287	6	3535	90	175	237	25	120	89	15,5	15,5	21,00
SPB 300 06	TB060300	6	300	307	5	3535	90	175	257		120	89	15,5	15,5	22,00
SPB 315 06	TB060315	6	315	322	5	3535	90	175	272		120	89	15,5	15,5	23,00
SPB 335 06	TB060335	6	335	342	5	3535	90	175	292		120	89	15,5	15,5	24,80
SPB 355 06	TB060355	6	355	362	5	3535	90	175	312		120	89	15,5	15,5	26,00
SPB 400 06	TB060400	6	400	407	5	3535	90	175	357		120	89	15,5	15,5	29,50
SPB 450 06	TB060450	6	450	457	5	4040	100	210	407		120	102	18		39,00
SPB 500 06	TB060500	6	500	507	5	4040	100	210	457		120	102	18		43,00
SPB 560 06	TB060560	6	560	567	5	4040	100	210	517		120	102	18		47,00
SPB 630 06	TB060630	6	630	637	5	4040	100	210	587		120	102	18		55,00
SPB 710 06	TB060710	6	710	717	5	4040	100	210	664		120	102	9	9	66,00
SPB 800 06	TB060800	6	800	807	5	4545	110	242	754		120	114	3	3	79,00
SPB 900 06	TB060900	6	900	907	5	4545	110	242	854		120	114	3	3	96,00
SPB1000 06	TB061000	6	1000	1007	5	4545	110	242	954		120	114	3	3	109,00
SPB1250 06	TB061250	6	1250	1257	5	4545	110	242	1204		120	114	3	3	142,00



PULEGGE A GOLE TRAPEZOIDALI PER BUSSOLA CONICA V-BELTS PULLEYS FOR TAPER BUSH

SPB - 8

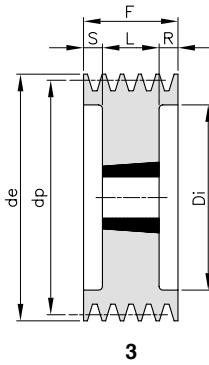

3

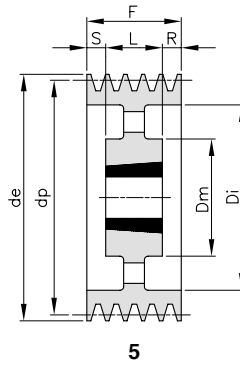

5

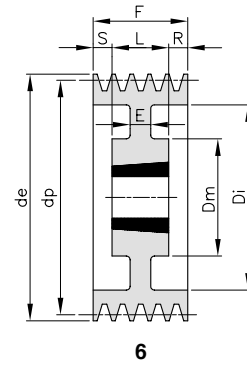

6

Materiale: GHISA EN-GJL-200

descrizione	codice	gole	dp	de	tipo	bussola	foro max	Dm	Di	E	F	L	R	S	Kg.
SPB 140 08	TB080140	8	140	147	3	2517	65		97		158	45	56,5	56,5	6,80
SPB 150 08	TB080150	8	150	157	3	2517	65		107		158	45	56,5	56,5	7,80
SPB 160 08	TB080160	8	160	167	3	3020	75		118		158	51	53,5	53,5	7,70
SPB 170 08	TB080170	8	170	177	3	3030	75		127		158	76	41	41	10,10
SPB 180 08	TB080180	8	180	187	3	3030	75		137		158	76	41	41	11,80
SPB 190 08	TB080190	8	190	197	3	3030	75		147		158	76	41	41	13,20
SPB 200 08	TB080200	8	200	207	3	3535	90		157		158	89	34,5	34,5	14,50
SPB 212 08	TB080212	8	212	219	3	3535	90		169		158	89	34,5	34,5	17,00
SPB 224 08	TB080224	8	224	231	3	3535	90		181		158	89	34,5	34,5	19,50
SPB 236 08	TB080236	8	236	243	3	3535	90		193		158	89	34,5	34,5	22,50
SPB 250 08	TB080250	8	250	257	3	3535	90		207		158	89	34,5	34,5	26,00
SPB 280 08	TB080280	8	280	287	6	3535	90	175	237	25	158	89	34,5	34,5	25,00
SPB 300 08	TB080300	8	300	307	6	3535	90	175	257	25	158	89	34,5	34,5	27,50
SPB 315 08	TB080315	8	315	322	5	3535	90	175	272		158	89	34,5	34,5	26,50
SPB 335 08	TB080335	8	335	342	5	3535	90	175	292		158	89	34,5	34,5	29,00
SPB 355 08	TB080355	8	355	362	5	3535	90	175	312		158	89	34,5	34,5	30,00
SPB 400 08	TB080400	8	400	407	5	4040	100	210	357		158	102	28	28	40,00
SPB 450 08	TB080450	8	450	457	5	4040	100	210	407		158	102	28	28	46,00
SPB 500 08	TB080500	8	500	507	5	4040	100	210	457		158	102	28	28	53,00
SPB 560 08	TB080560	8	560	567	5	4545	110	242	517		158	114	22	22	65,00
SPB 630 08	TB080630	8	630	637	5	4545	110	242	587		158	114	22	22	75,00
SPB 710 08	TB080710	8	710	717	5	4545	110	242	664		158	114	22	22	85,00
SPB 800 08	TB080800	8	800	807	5	4545	110	242	754		158	114	22	22	100,00
SPB 900 08	TB080900	8	900	907	5	4545	110	242	854		158	114	22	22	113,00
SPB1000 08	TB081000	8	1000	1007	5	5050	125	267	954		158	127	15,5	15,5	137,00
SPB1250 08	TB081250	8	1250	1257	5	5050	125	267	1204		158	127	15,5	15,5	190,00



PULEGGE A GOLE TRAPEZOIDALI PER BUSSOLA CONICA V-BELTS PULLEYS FOR TAPER BUSH

SPB - 10

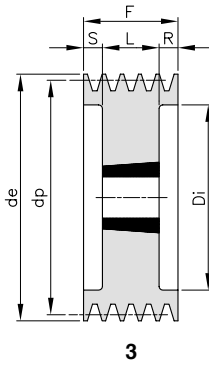

3

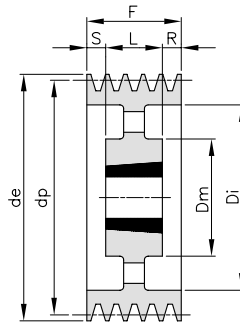

5

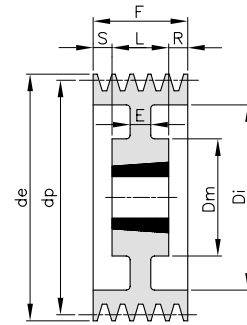

6

Materiale: GHISA EN-GJL-200

descrizione	codice	gole	dp	de	tipo	bussola	foro max	Dm	Di	E	F	L	R	S	Kg.
SPB 224 10	TB100224	10	224	231	3	3535	90		181		196	89	53,5	53,5	22,50
SPB 236 10	TB100236	10	236	243	3	3535	90		193		196	89	53,5	53,5	25,00
SPB 250 10	TB100250	10	250	257	3	3535	90		207		196	89	53,5	53,5	29,00
SPB 280 10	TB100280	10	280	287	6	3535	90	175	237	30	196	89	53,5	53,5	29,50
SPB 315 10	TB100315	10	315	322	6	3535	90	175	272	30	196	89	53,5	53,5	40,00
SPB 335 10	TB100335	10	335	342	5	4040	100	210	292		196	102	47	47	43,00
SPB 355 10	TB100355	10	355	362	5	4040	100	210	312		196	102	47	47	45,00
SPB 400 10	TB100400	10	400	407	5	4040	100	210	357		196	102	47	47	46,00
SPB 450 10	TB100450	10	450	457	5	4545	110	242	407		196	114	41	41	58,00
SPB 500 10	TB100500	10	500	507	5	4545	110	242	457		196	114	41	41	65,00
SPB 560 10	TB100560	10	560	567	5	4545	110	242	517		196	114	41	41	67,00
SPB 630 10	TB100630	10	630	637	5	4545	110	242	587		196	114	41	41	81,00
SPB 710 10	TB100710	10	710	717	5	4545	110	242	664		196	114	41	41	95,00
SPB 800 10	TB100800	10	800	807	5	4545	110	242	754		196	114	41	41	103,00
SPB 900 10	TB100900	10	900	907	5	5050	125	267	854		196	127	34,5	34,5	133,00
SPB1000 10	TB101000	10	1000	1007	5	5050	125	267	954		196	127	34,5	34,5	146,00
SPB1250 10	TB101250	10	1250	1257	5	5050	125	267	1204		196	127	34,5	34,5	218,00



PULEGGE A GOLE TRAPEZOIDALI PER BUSSOLA CONICA V-BELTS PULLEYS FOR TAPER BUSH

SPC - 3

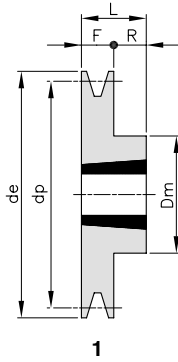

1

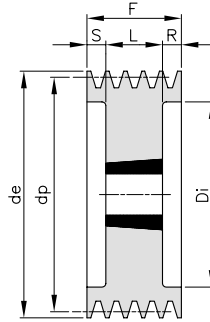

3

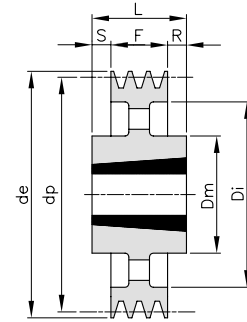

4

Materiale: GHISA EN-GJL-200

descrizione	codice	gole	dp	de	tipo	bussola	foro max	Dm	Di	E	F	L	R	S	Kg.
SPC 200 03	TC030200	3	200	209,6	3	2517	65		144		85	45	20	20	10,00
SPC 212 03	TC030212	3	212	221,6	3	3020	75		156		85	51	17	17	10,60
SPC 224 03	TC030224	3	224	233,6	3	3020	75		168		85	51	17	17	12,40
SPC 236 03	TC030236	3	236	245,6	3	3020	75		180		85	51	17	17	14,10
SPC 250 03	TC030250	3	250	259,6	3	3020	75		194		85	51	17	17	16,00
SPC 265 03	TC030265	3	265	274,6	1	3535	90	175			85	89	4		23,00
SPC 280 03	TC030280	3	280	289,6	1	3535	90	175			85	89	4		27,30
SPC 300 03	TC030300	3	300	309,6	4	3535	90	175	244		85	89	2	2	20,50
SPC 315 03	TC030315	3	315	324,6	4	3535	90	175	259		85	89	2	2	21,50
SPC 335 03	TC030335	3	335	344,6	4	3535	90	175	279		85	89	2	2	23,50
SPC 355 03	TC030355	3	355	364,6	4	3535	90	175	299		85	89	2	2	24,50
SPC 375 03	TC030375	3	375	384,6	4	3535	90	175	319		85	89	2	2	25,50
SPC 400 03	TC030400	3	400	409,6	4	3535	90	175	344		85	89	2	2	27,00
SPC 425 03	TC030425	3	425	434,6	4	3535	90	175	369		85	89	2	2	29,00
SPC 450 03	TC030450	3	450	459,6	4	3535	90	175	394		85	89	2	2	32,00
SPC 475 03	TC030475	3	475	484,6	4	3535	90	175	419		85	89	2	2	34,00
SPC 500 03	TC030500	3	500	509,6	4	3535	90	175	444		85	89	2	2	36,00
SPC 530 03	TC030530	3	530	539,6	4	3535	90	175	474		85	89	2	2	37,50
SPC 560 03	TC030560	3	560	569,6	4	3535	90	175	504		85	89	2	2	40,00
SPC 630 03	TC030630	3	630	639,6	4	4040	100	210	574		85	102	8,5	8,5	52,00
SPC 800 03	TC030800	3	800	809,6	4	4545	110	242	737		85	114	14,5	14,5	80,00
SPC1000 03	TC031000	3	1000	1009,6	4	5050	125	267	937		85	127	21	21	113,00
SPC1250 03	TC031250	3	1250	1259,6	4	5050	125	267	1187		85	127	21	21	138,00



PULEGGE A GOLE TRAPEZOIDALI PER BUSSOLA CONICA V-BELTS PULLEYS FOR TAPER BUSH

SPC - 4

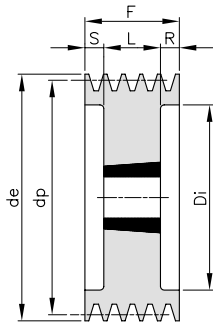

3

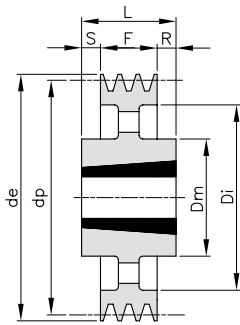

4

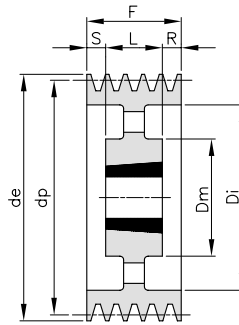

5

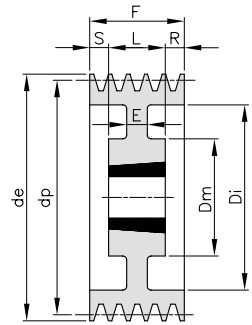

6

Materiale: GHISA EN-GJL-200

descrizione	codice	gole	dp	de	tipo	bussola	foro max	Dm	Di	E	F	L	R	S	Kg.
SPC 200 04	TC040200	4	200	209,6	3	3020	75		144		111	51	30	30	11,00
SPC 212 04	TC040212	4	212	221,6	3	3020	75		156		111	51	30	30	12,50
SPC 224 04	TC040224	4	224	233,6	3	3535	90		168		111	89	11	11	16,00
SPC 236 04	TC040236	4	236	245,6	3	3535	90		180		111	89	11	11	18,50
SPC 250 04	TC040250	4	250	259,6	3	3535	90		194		111	89	11	11	22,00
SPC 265 04	TC040265	4	265	274,6	3	3535	90		209		111	89	11	11	26,00
SPC 280 04	TC040280	4	280	289,6	6	3535	90	175	224	18	111	89	11	11	25,40
SPC 300 04	TC040300	4	300	309,6	6	3535	90	175	244	20	111	89	11	11	30,00
SPC 315 04	TC040315	4	315	324,6	5	3535	90	175	259		111	89	11	11	24,00
SPC 335 04	TC040335	4	335	344,6	5	3535	90	175	279		111	89	11	11	27,00
SPC 355 04	TC040355	4	355	364,6	5	3535	90	175	299		111	89	11	11	28,30
SPC 375 04	TC040375	4	375	384,6	5	3535	90	175	319		111	89	11	11	30,00
SPC 400 04	TC040400	4	400	409,6	5	3535	90	175	344		111	89	11	11	34,00
SPC 425 04	TC040425	4	425	434,6	5	3535	90	175	369		111	89	11	11	35,00
SPC 450 04	TC040450	4	450	459,6	5	3535	90	175	394		111	89	11	11	37,00
SPC 475 04	TC040475	4	475	484,6	5	3535	90	175	419		111	89	11	11	39,00
SPC 500 04	TC040500	4	500	509,6	5	3535	90	175	444		111	89	11	11	43,00
SPC 530 04	TC040530	4	530	539,6	5	4040	100	210	474		111	102	4,5	4,5	50,00
SPC 560 04	TC040560	4	560	569,6	5	4040	100	210	504		111	102	4,5	4,5	54,00
SPC 630 04	TC040630	4	630	639,6	4	4545	110	242	574		111	114	1,5	1,5	66,00
SPC 710 04	TC040710	4	710	719,6	4	5050	125	267	654		111	127	8	8	82,00
SPC 800 04	TC040800	4	800	809,6	4	5050	125	267	737		111	127	8	8	100,00
SPC1000 04	TC041000	4	1000	1009,6	4	5050	125	267	937		111	127	8	8	126,00
SPC1250 04	TC041250	4	1250	1259,6	4	5050	125	267	1187		111	127	8	8	175,00



PULEGGE A GOLE TRAPEZOIDALI PER BUSSOLA CONICA V-BELTS PULLEYS FOR TAPER BUSH

SPC - 5

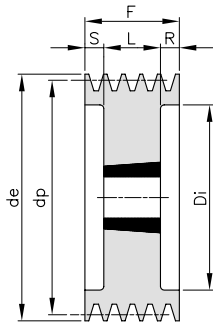

3

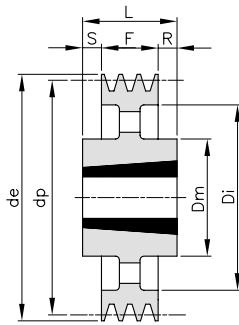

4

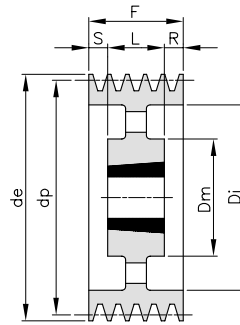

5

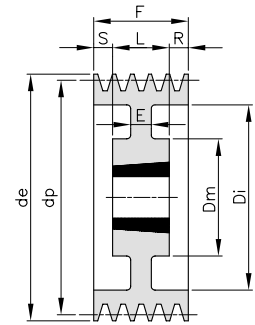

6

Materiale: GHISA EN-GJL-200

descrizione	codice	gole	dp	de	tipo	bussola	foro max	Dm	Di	E	F	L	R	S	Kg.
SPC 200 05	TC050200	5	200	209,6	3	3535	90		144		136	89	23,5	23,5	13,00
SPC 212 05	TC050212	5	212	221,6	3	3535	90		156		136	89	23,5	23,5	15,60
SPC 224 05	TC050224	5	224	233,6	3	3535	90		168		136	89	23,5	23,5	18,40
SPC 236 05	TC050236	5	236	245,6	3	3535	90		180		136	89	23,5	23,5	21,20
SPC 250 05	TC050250	5	250	259,6	3	3535	90		194		136	89	23,5	23,5	24,70
SPC 265 05	TC050265	5	265	274,6	3	3535	90		209		136	89	23,5	23,5	28,60
SPC 280 05	TC050280	5	280	289,6	3	3535	90		224		136	89	23,5	23,5	33,00
SPC 300 05	TC050300	5	300	309,6	6	3535	90	175	244	20	136	89	23,5	23,5	30,50
SPC 315 05	TC050315	5	315	324,6	5	3535	90	175	259		136	89	23,5	23,5	28,00
SPC 335 05	TC050335	5	335	344,6	5	3535	90	175	279		136	89	23,5	23,5	31,00
SPC 355 05	TC050355	5	355	364,6	5	3535	90	175	299		136	89	23,5	23,5	33,50
SPC 375 05	TC050375	5	375	384,6	5	3535	90	175	319		136	89	23,5	23,5	35,00
SPC 400 05	TC050400	5	400	409,6	5	3535	90	175	344		136	89	23,5	23,5	37,00
SPC 425 05	TC050425	5	425	434,6	5	3535	90	175	369		136	89	23,5	23,5	40,00
SPC 450 05	TC050450	5	450	459,6	5	4040	100	210	394		136	102	17	17	46,00
SPC 475 05	TC050475	5	475	484,6	5	4040	100	210	419		136	102	17	17	50,30
SPC 500 05	TC050500	5	500	509,6	5	4040	100	210	444		136	102	17	17	53,00
SPC 530 05	TC050530	5	530	539,6	5	4545	110	240	474		136	114	11	11	65,00
SPC 560 05	TC050560	5	560	569,6	5	4545	110	242	504		136	114	11	11	68,00
SPC 630 05	TC050630	5	630	639,6	5	5050	125	267	574		136	127	4,5	4,5	81,00
SPC 710 05	TC050710	5	710	719,6	5	5050	125	267	654		136	127	4,5	4,5	96,50
SPC 800 05	TC050800	5	800	809,6	5	5050	125	267	737		136	127	4,5	4,5	94,00
SPC1000 05	TC051000	5	1000	1009,6	5	5050	125	267	937		136	127	4,5	4,5	139,00
SPC1250 05	TC051250	5	1250	1259,6	5	5050	125	267	1187		136	127	4,5	4,5	191,00



PULEGGE A GOLE TRAPEZOIDALI PER BUSSOLA CONICA V-BELTS PULLEYS FOR TAPER BUSH

SPC - 6

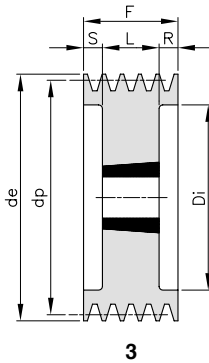

3

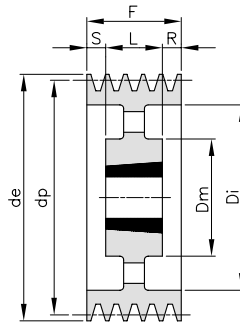

5

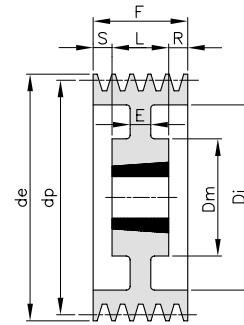

6

Materiale: GHISA EN-GJL-200

descrizione	codice	gole	dp	de	tipo	bussola	foro max	Dm	Di	E	F	L	R	S	Kg.
SPC 200 06	TC060200	6	200	209,6	3	3535	90		144		162	89	36,5	36,5	15,00
SPC 212 06	TC060212	6	212	221,6	3	3535	90		156		162	89	36,5	36,5	17,80
SPC 224 06	TC060224	6	224	233,6	3	3535	90		168		162	89	36,5	36,5	20,50
SPC 236 06	TC060236	6	236	245,6	3	3535	90		180		162	89	36,5	36,5	23,50
SPC 250 06	TC060250	6	250	259,6	3	3535	90		194		162	89	36,5	36,5	27,20
SPC 265 06	TC060265	6	265	274,6	3	3535	90		209		162	89	36,5	36,5	31,00
SPC 280 06	TC060280	6	280	289,6	6	3535	90	175	224	20	162	89	36,5	36,5	28,00
SPC 300 06	TC060300	6	300	309,6	6	3535	90	175	244	20	162	89	36,5	36,5	31,50
SPC 315 06	TC060315	6	315	324,6	5	3535	90	175	259		162	89	36,5	36,5	32,00
SPC 335 06	TC060335	6	335	344,6	5	3535	90	175	279		162	89	36,5	36,5	35,00
SPC 355 06	TC060355	6	355	364,6	5	3535	90	175	299		162	89	36,5	36,5	37,00
SPC 375 06	TC060375	6	375	384,6	5	4040	100	210	319		162	102	30	30	46,00
SPC 400 06	TC060400	6	400	409,6	5	4040	100	210	344		162	102	30	30	48,00
SPC 425 06	TC060425	6	425	434,6	5	4040	100	210	369		162	102	30	30	51,00
SPC 450 06	TC060450	6	450	459,6	5	4545	110	242	394		162	114	24	24	60,00
SPC 475 06	TC060475	6	475	484,6	5	4545	110	242	419		162	114	24	24	63,00
SPC 500 06	TC060500	6	500	509,6	5	4545	110	242	444		162	114	24	24	68,00
SPC 530 06	TC060530	6	530	539,6	5	5050	125	265	474		162	127	17,5	17,5	76,00
SPC 560 06	TC060560	6	560	569,6	5	5050	125	267	504		162	127	17,5	17,5	81,00
SPC 630 06	TC060630	6	630	639,6	5	5050	125	267	574		162	127	17,5	17,5	90,00
SPC 710 06	TC060710	6	710	719,6	5	5050	125	267	654		162	127	17,5	17,5	103,00
SPC 800 06	TC060800	6	800	809,6	5	5050	125	267	737		162	127	17,5	17,5	123,00
SPC1000 06	TC061000	6	1000	1009,6	5	5050	125	267	937		162	127	17,5	17,5	160,00
SPC1250 06	TC061250	6	1250	1259,6	5	5050	125	267	1187		162	127	17,5	17,5	204,00



PULEGGE A GOLE TRAPEZOIDALI PER BUSSOLA CONICA V-BELTS PULLEYS FOR TAPER BUSH

SPC - 8

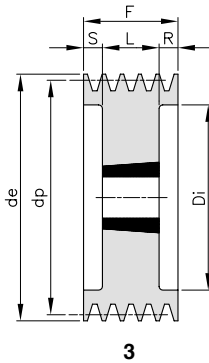

3

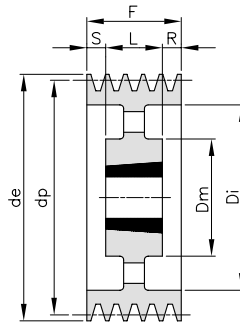

5

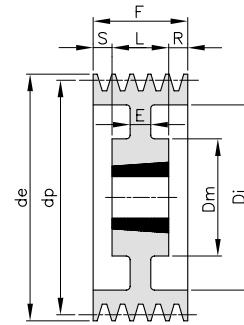

6

Materiale: GHISA EN-GJL-200

descrizione	codice	gole	dp	de	tipo	bussola	foro max	Dm	Di	E	F	L	R	S	Kg.
SPC 200 08	TC080200	8	200	209,6	3	3535	90		144		213	89	62	62	18,60
SPC 212 08	TC080212	8	212	221,6	3	3535	90		156		213	89	62	62	21,60
SPC 224 08	TC080224	8	224	233,6	3	3535	90		168		213	89	62	62	25,00
SPC 236 08	TC080236	8	236	245,6	3	3535	90		180		213	89	62	62	27,00
SPC 250 08	TC080250	8	250	259,6	3	3535	90		194		213	89	62	62	31,50
SPC 265 08	TC080265	8	265	274,6	3	3535	90		209		213	89	62	62	36,50
SPC 280 08	TC080280	8	280	289,6	3	3535	90		224		213	89	62	62	40,00
SPC 300 08	TC080300	8	300	309,6	3	4040	100		244		213	102	55,5	55,5	48,50
SPC 315 08	TC080315	8	315	324,6	3	4040	100		259		213	102	55,5	55,5	53,00
SPC 335 08	TC080335	8	335	344,6	6	4040	100	210	279	50	213	102	55,5	55,5	53,00
SPC 355 08	TC080355	8	355	364,6	5	4040	100	210	299		213	102	55,5	55,5	50,00
SPC 375 08	TC080375	8	375	384,6	5	4545	110	242	319		213	114	49,5	49,5	61,00
SPC 400 08	TC080400	8	400	409,6	5	4545	110	242	344		213	114	49,5	49,5	65,00
SPC 425 08	TC080425	8	425	434,6	5	4545	110	242	369		213	114	49,5	49,5	70,50
SPC 450 08	TC080450	8	450	459,6	5	5050	125	267	394		213	127	43	43	79,00
SPC 475 08	TC080475	8	475	484,6	5	5050	125	267	419		213	127	43	43	84,00
SPC 500 08	TC080500	8	500	509,6	5	5050	125	267	444		213	127	43	43	88,00
SPC 530 08	TC080530	8	530	539,6	5	5050	125	267	474		213	127	43	43	91,00
SPC 560 08	TC080560	8	560	569,6	5	5050	125	267	504		213	127	43	43	97,00
SPC 630 08	TC080630	8	630	639,6	5	5050	125	267	574		213	127	43	43	110,00
SPC 710 08	TC080710	8	710	719,6	5	5050	125	267	654		213	127	43	43	121,00
SPC 800 08	TC080800	8	800	809,6	5	5050	125	267	737		213	127	43	43	143,00
SPC1000 08	TC081000	8	1000	1009,6	5	5050	125	267	937		213	127	43	43	190,00
SPC1250 08	TC081250	8	1250	1259,6	5	5050	125	267	1187		213	127	43	43	251,00



PULEGGE A GOLE TRAPEZOIDALI PER BUSSOLA CONICA V-BELTS PULLEYS FOR TAPER BUSH

SPC - 10

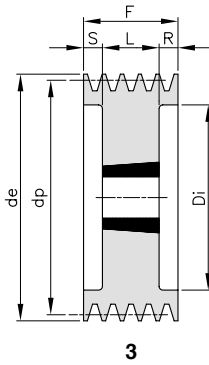

3

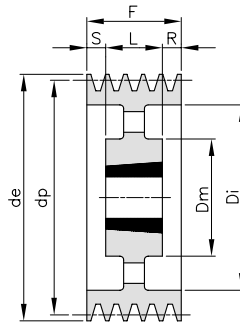

5

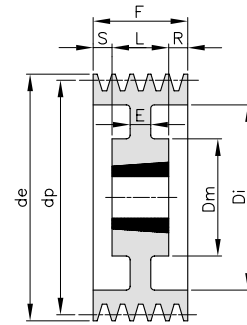

6

Materiale: GHISA EN-GJL-200

descrizione	codice	gole	dp	de	tipo	bussola	foro max	Dm	Di	E	F	L	R	S	Kg.
SPC 250 10	TC100250	10	250	259,6	3	4040	100		194		264	102	81	81	35,50
SPC 280 10	TC100280	10	280	289,6	3	4040	100		224		264	102	81	81	45,50
SPC 300 10	TC100300	10	300	309,6	3	4545	110		244		264	114	75	75	57,90
SPC 315 10	TC100315	10	315	324,6	3	4545	110		259		264	114	75	75	60,00
SPC 335 10	TC100335	10	335	344,6	3	4545	110		279		264	114	75	75	70,00
SPC 355 10	TC100355	10	355	364,6	3	4545	110		299		264	114	75	75	80,00
SPC 400 10	TC100400	10	400	409,6	6	5050	125	267	344	70	264	127	68,5	68,5	92,00
SPC 450 10	TC100450	10	450	459,6	5	5050	125	267	394		264	127	68,5	68,5	100,90
SPC 500 10	TC100500	10	500	509,6	5	5050	125	267	444		264	127	68,5	68,5	114,00
SPC 560 10	TC100560	10	560	569,6	5	5050	125	267	504		264	127	68,5	68,5	111,00
SPC 630 10	TC100630	10	630	639,6	5	5050	125	267	574		264	127	68,5	68,5	128,00
SPC 710 10	TC100710	10	710	719,6	5	5050	125	267	654		264	127	68,5	68,5	140,00
SPC 800 10	TC100800	10	800	809,6	5	5050	125	267	737		264	127	68,5	68,5	177,00
SPC1000 10	TC101000	10	1000	1009,6	5	5050	125	267	937		264	127	68,5	68,5	220,00
SPC1250 10	TC101250	10	1250	1259,6	5	5050	125	267	1187		264	127	68,5	68,5	298,00

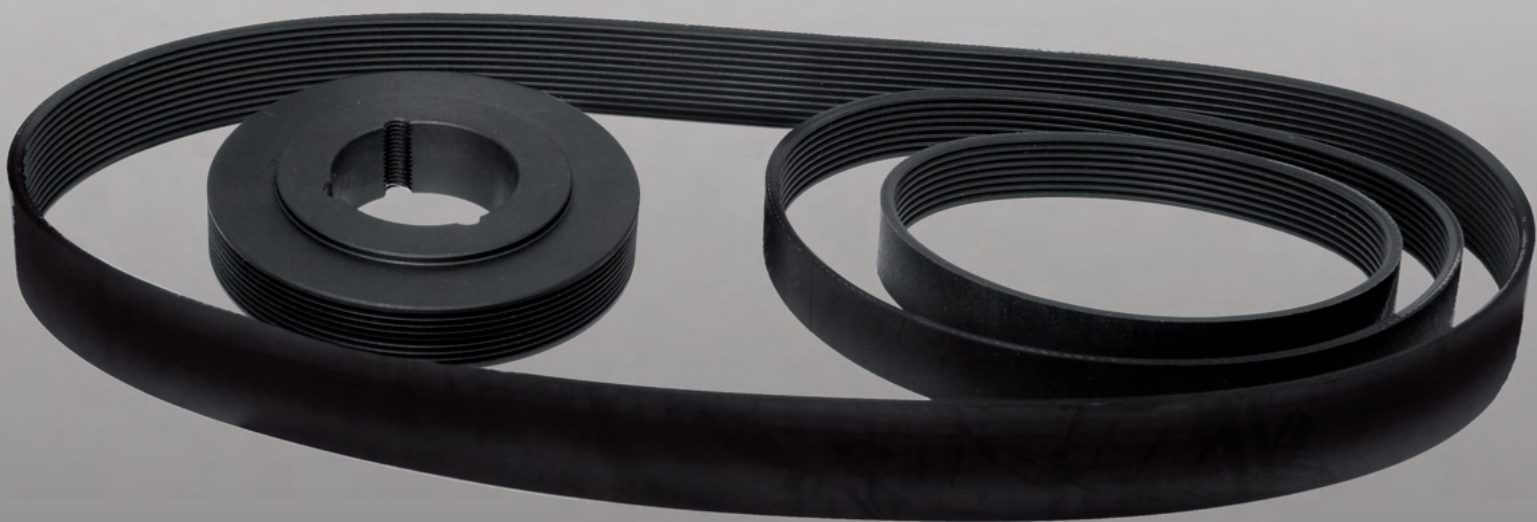



PULEGGE SCANALATE POLY-V PER BUSSOLA CONICA POLY-V PULLEYS FOR TAPER BUSH

Descrizione e caratteristiche - Description and features

Le pulegge a profilo scanalato a sezione triangolare sono costruite secondo le specifiche ISO 9982 / DIN 7867

Our Poly-V pulleys are manufactured according to International Standard ISO 9982 / DIN 7867

Materiale - Material

Ghisa EN-GJL-200 (G20 - UNI 5007)

Cast iron EN-GJL-200 (G20 - UNI 5007)

Trattamento e Bilanciatura

Protective treatment and balancing

Tutte le pulegge standard sono protette con un trattamento superficiale di FOSFATAZIONE e BILANCIATE STATICAMENTE per essere idonee ad un funzionamento fino alla velocità periferica di 30 m/sec.

The surface of all our standard Poly-V pulleys is protected by phosphated treatment. All the pulleys are Statically Balanced and can be used for peripheric speed up to 30 m/sec



Calcolo della velocità periferica (Vp)

Periferic speed table (Vp)

$$V_p = \frac{\pi \cdot dp \cdot n}{60 \cdot 1000} = \frac{dp \cdot n}{19100} = \text{m/sec}$$

dp = diametro in mm - diameter/mm

n = giri al minuto - revolutions per minute

Vp = velocità in m/s - speed m/s

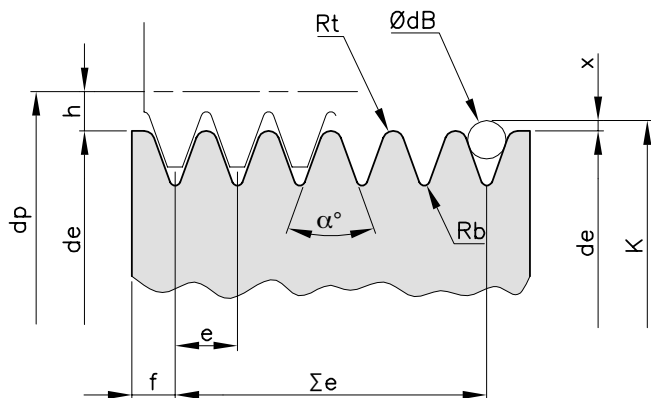

Dimensioni puleggia Dimensions of Pulley

Profilo		J		L	
Passo delle gole - e	(mm)	2,34	± 0,03	4,70	± 0,05
Angolo gola	(α°)	40°	± 0,5	40°	± 0,5
Rt min	(mm)	0,20		0,40	
Rb max	(mm)	0,40		0,40	
Σ e	(mm)	e x (z - 1)	± 0,3	e x (z - 1)	± 0,3
ØdB diametro sfera / rullo di controllo	(mm)	1,50	± 0,01	3,50	± 0,01
2 X	(mm)	0,23		2,36	
h	(mm)	1,20		3,00	
dp	(mm)	de + (2 * h)		de + (2 * h)	
f min	(mm)	1,80		3,30	
f reale (mm)	8 gole	3,31		7,55	
	12 gole	3,38		7,65	
	16 gole	3,45		7,75	



PULEGGE SCANALATE POLY-V PER BUSSOLA CONICA POLY-V PULLEYS FOR TAPER BUSH

Sezione J 8 GOLE

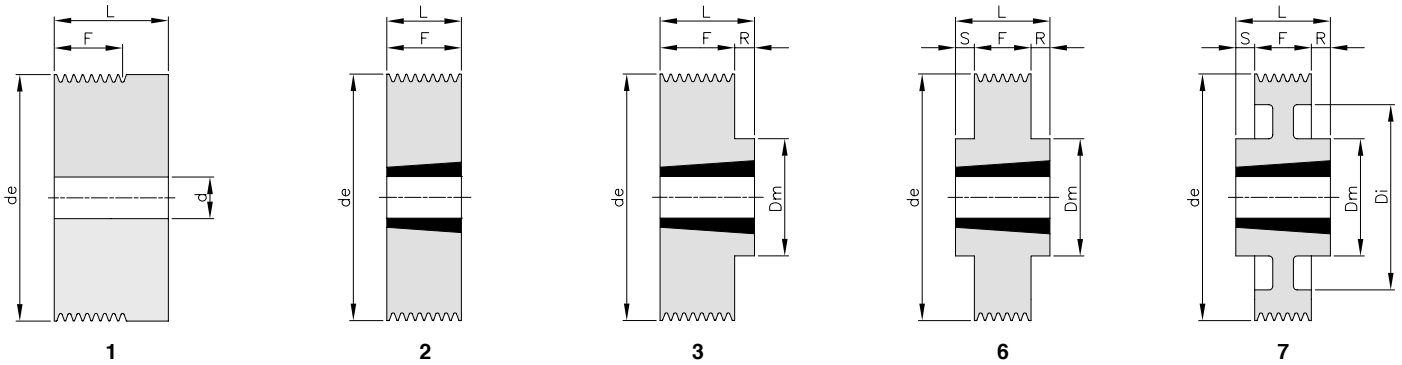

Materiale: GHISA EN-GJL-200

descrizione	codice	gole	de	tipo	bussola	foro max	Dm	Di	F	L	R	S	d	Kg.
J 40 08	PJ08040	8	40	1					19,7	32			12	0,24
J 45 08	PJ08045	8	45	1					19,7	32			12	0,32
J 50 08	PJ08050	8	50	1					19,7	32			12	0,40
J 56 08	PJ08056	8	56	2	1108	28			23	23				0,20
J 63 08	PJ08063	8	63	2	1108	28			23	23				0,30
J 71 08	PJ08071	8	71	2	1108	28			23	23				0,44
J 75 08	PJ08075	8	75	2	1108	28			23	23				0,52
J 80 08	PJ08080	8	80	3	1610	42	70		23	26	3			0,41
J 85 08	PJ08085	8	85	3	1610	42	70		23	26	3			0,51
J 90 08	PJ08090	8	90	3	1610	42	70		23	26	3			0,62
J 95 08	PJ08095	8	95	3	1610	42	82		23	26	3			0,78
J 100 08	PJ08100	8	100	3	1610	42	82		23	26	3			0,90
J 106 08	PJ08106	8	106	3	1610	42	82		23	26	3			1,05
J 112 08	PJ08112	8	112	3	1610	42	90		23	26	3			1,25
J 118 08	PJ08118	8	118	3	1610	42	90		23	26	3			1,43
J 125 08	PJ08125	8	125	3	1610	42	90		23	26	3			1,64
J 132 08	PJ08132	8	132	3	1610	42	90		23	26	3			1,88
J 140 08	PJ08140	8	140	3	1610	42	90		23	26	3			2,16
J 160 08	PJ08160	8	160	6	2012	50	110		23	32	4,5	4,5		3,01
J 180 08	PJ08180	8	180	6	2012	50	110		23	32	4,5	4,5		3,92
J 190 08	PJ08190	8	190	6	2012	50	110		23	32	4,5	4,5		4,38
J 200 08	PJ08200	8	200	6	2012	50	110		23	32	4,5	4,5		4,88
J 212 08	PJ08212	8	212	6	2012	50	110		23	32	4,5	4,5		5,49
J 224 08	PJ08224	8	224	6	2012	50	110		23	32	4,5	4,5		6,17
J 250 08	PJ08250	8	250	6	2012	50	110		23	32	4,5	4,5		7,73
J 280 08	PJ08280	8	280	7	2012	50	110	260	23	32	4,5	4,5		5,78
J 315 08	PJ08315	8	315	7	2012	50	110	295	23	32	4,5	4,5		6,92



PULEGGE SCANALATE POLY-V PER BUSSOLA CONICA POLY-V PULLEYS FOR TAPER BUSH

Sezione J 12 GOLE

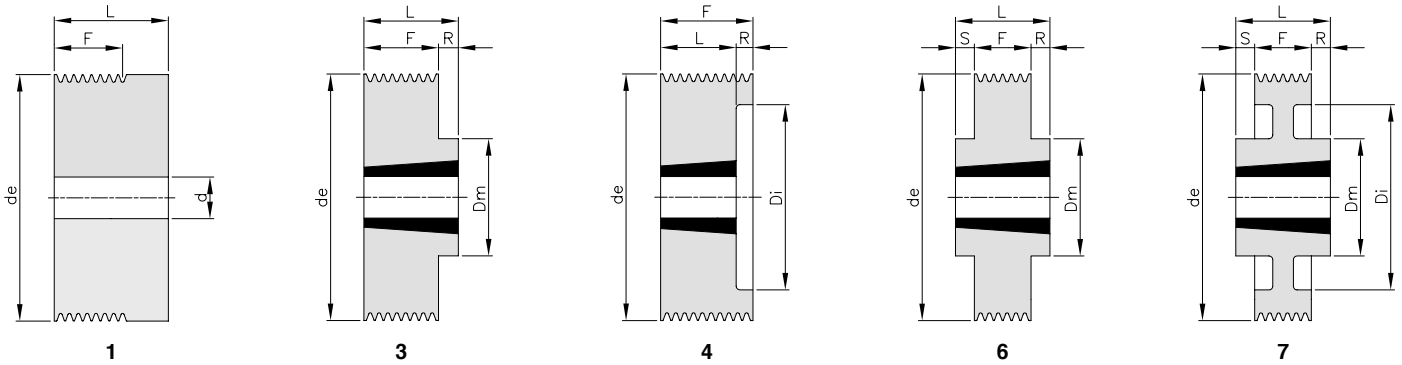

Materiale: GHISA EN-GJL-200

descrizione	codice	gole	de	tipo	bussola	foro max	Dm	Di	F	L	R	S	d	Kg.
J 40 12	PJ12040	12	40	1					29,1	41,5			12	0,31
J 45 12	PJ12045	12	45	1					29,1	41,5			12	0,41
J 50 12	PJ12050	12	50	1					29,1	41,5			12	0,52
J 56 12	PJ12056	12	56	4	1108	28	40		32,5	23	9,50			0,28
J 63 12	PJ12063	12	63	4	1108	28	46		32,5	23	9,50			0,39
J 71 12	PJ12071	12	71	4	1108	28	46		32,5	23	9,50			0,57
J 75 12	PJ12075	12	75	4	1610	42	60		32,5	26	6,50			0,38
J 80 12	PJ12080	12	80	4	1610	42	60		32,5	26	6,50			0,52
J 85 12	PJ12085	12	85	4	1610	42	60		32,5	26	6,50			0,66
J 90 12	PJ12090	12	90	4	1610	42	74		32,5	26	6,50			0,76
J 95 12	PJ12095	12	95	4	1610	42	74		32,5	26	6,50			0,93
J 100 12	PJ12100	12	100	4	1610	42	74		32,5	26	6,50			1,10
J 106 12	PJ12106	12	106	4	1610	42	88		32,5	26	6,50			1,24
J 112 12	PJ12112	12	112	4	1610	42	88		32,5	26	6,50			1,47
J 118 12	PJ12118	12	118	4	2012	50	98		32,5	32	0,50			1,55
J 125 12	PJ12125	12	125	4	2012	50	98		32,5	32	0,50			1,90
J 132 12	PJ12132	12	132	4	2012	50	98		32,5	32	0,50			2,21
J 140 12	PJ12140	12	140	3	2517	65	120		32,5	45	12,50			2,71
J 160 12	PJ12160	12	160	3	2517	65	120		32,5	45	12,50			3,80
J 180 12	PJ12180	12	180	6	2517	65	120		32,5	45	6,25	6,25		5,03
J 190 12	PJ12190	12	190	6	2517	65	120		32,5	45	6,25	6,25		5,72
J 200 12	PJ12200	12	200	6	2517	65	120		32,5	45	6,25	6,25		6,40
J 212 12	PJ12212	12	212	6	2517	65	120		32,5	45	6,25	6,25		7,33
J 224 12	PJ12224	12	224	6	2517	65	120		32,5	45	6,25	6,25		8,29
J 250 12	PJ12250	12	250	6	2517	65	120		32,5	45	6,25	6,25		10,47
J 280 12	PJ12280	12	280	7	2517	65	120	260	32,5	45	6,25	6,25		7,38
J 315 12	PJ12315	12	315	7	2517	65	120	295	32,5	45	6,25	6,25		8,99



PULEGGE SCANALATE POLY-V PER BUSSOLA CONICA POLY-V PULLEYS FOR TAPER BUSH

Sezione J 16 GOLE

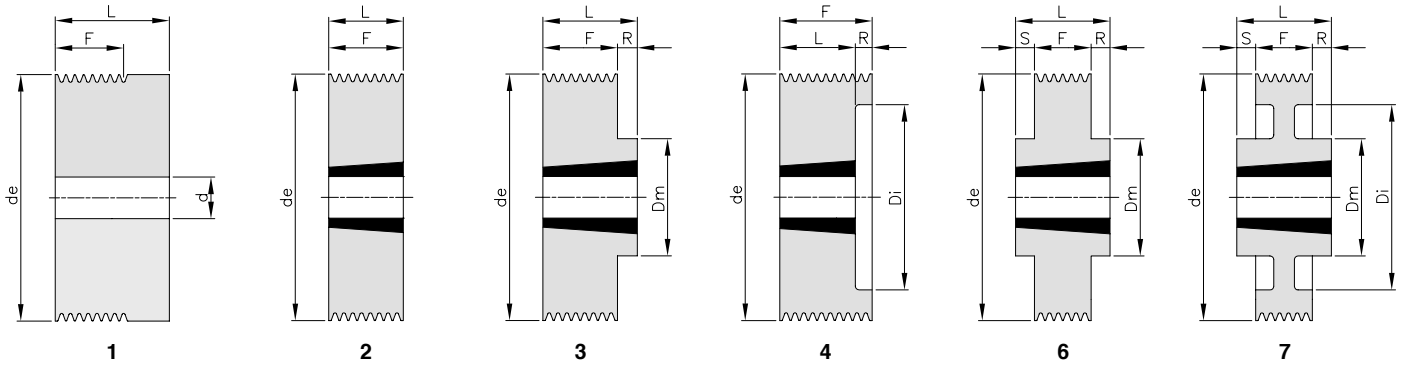

Materiale: GHISA EN-GJL-200

descrizione	codice	gole	de	tipo	bussola	foro max	Dm	Di	F	L	R	S	d	Kg.
J 40 16	PJ16040	16	40	1					38,5	51			12	0,38
J 45 16	PJ16045	16	45	1					38,5	51			12	0,50
J 50 16	PJ16050	16	50	1					38,5	51			12	0,63
J 56 16	PJ16056	16	56	1					38,5	51			12	0,81
J 63 16	PJ16063	16	63	1					38,5	51			12	1,05
J 71 16	PJ16071	16	71	2	1215	32	55	42	42					0,63
J 75 16	PJ16075	16	75	4	1610	42	60	42	26	16				0,46
J 80 16	PJ16080	16	80	4	1610	42	60	42	26	16				0,64
J 85 16	PJ16085	16	85	4	1610	42	60	42	26	16				0,84
J 90 16	PJ16090	16	90	4	1610	42	74	42	26	16				0,87
J 95 16	PJ16095	16	95	4	1610	42	74	42	26	16				1,08
J 100 16	PJ16100	16	100	4	1610	42	74	42	26	16				1,32
J 106 16	PJ16106	16	106	4	1610	42	88	42	26	16				1,40
J 112 16	PJ16112	16	112	4	1610	42	88	42	26	16				1,70
J 118 16	PJ16118	16	118	4	2012	50	98	42	32	10				1,79
J 125 16	PJ16125	16	125	4	2012	50	98	42	32	10				2,18
J 132 16	PJ16132	16	132	4	2012	50	98	42	32	10				2,60
J 140 16	PJ16140	16	140	3	2517	65	120	42	45	3				2,96
J 160 16	PJ16160	16	160	3	2517	65	120	42	45	3				4,37
J 180 16	PJ16180	16	180	6	2517	65	120	42	45	1,5	1,5			5,97
J 190 16	PJ16190	16	190	6	2517	65	120	42	45	1,5	1,5			6,85
J 200 16	PJ16200	16	200	6	2517	65	120	42	45	1,5	1,5			7,75
J 212 16	PJ16212	16	212	6	2517	65	120	42	45	1,5	1,5			8,90
J 224 16	PJ16224	16	224	6	2517	65	120	42	45	1,5	1,5			10,10
J 250 16	PJ16250	16	250	6	2517	65	120	42	45	1,5	1,5			13,00
J 280 16	PJ16280	16	280	7	2517	65	120	260	42	45	1,5	1,5		8,38
J 315 16	PJ16315	16	315	7	2517	65	120	295	42	45	1,5	1,5		9,57



PULEGGE SCANALATE POLY-V PER BUSSOLA CONICA POLY-V PULLEYS FOR TAPER BUSH

Sezione L 8 GOLE

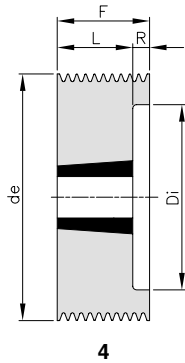

4

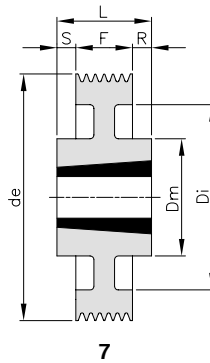

7

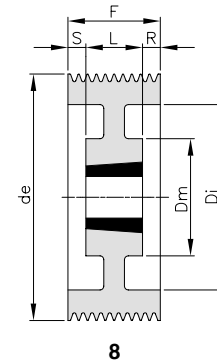

8

Materiale: GHISA EN-GJL-200

descrizione	codice	gole	de	tipo	bussola	foro max	Dm	Di	F	L	R	S	d	Kg.
L 75 08	PL08075	8	75	4	1210	32		56	48	26	22			0,66
L 80 08	PL08080	8	80	4	1210	32		56	48	26	22			0,86
L 85 08	PL08085	8	85	4	1210	32		61	48	26	22			1,00
L 90 08	PL08090	8	90	4	1610	42		66	48	26	22			1,01
L 95 08	PL08095	8	95	4	1610	42		71	48	26	22			1,16
L 100 08	PL08100	8	100	4	1610	42		76	48	26	22			1,31
L 106 08	PL08106	8	106	4	1610	42		82	48	26	22			1,53
L 112 08	PL08112	8	112	4	1610	42		88	48	26	22			1,75
L 118 08	PL08118	8	118	4	2012	50		94	48	32	16			1,88
L 125 08	PL08125	8	125	4	2012	50		101	48	32	16			2,22
L 132 08	PL08132	8	132	4	2012	50		108	48	32	16			2,54
L 140 08	PL08140	8	140	4	2517	65		116	48	45	3			3,02
L 150 08	PL08150	8	150	4	2517	65		126	48	45	3			3,75
L 160 08	PL08160	8	160	4	2517	65		136	48	45	3			4,54
L 170 08	PL08170	8	170	4	2517	65		146	48	45	3			4,35
L 180 08	PL08180	8	180	8	2517	65	120	156	48	45	1,5	1,5		4,52
L 190 08	PL08190	8	190	8	2517	65	120	166	48	45	1,5	1,5		4,72
L 200 08	PL08200	8	200	8	2517	65	120	176	48	45	1,5	1,5		5,07
L 212 08	PL08212	8	212	8	2517	65	120	188	48	45	1,5	1,5		5,50
L 224 08	PL08224	8	224	8	2517	65	120	202	48	45	1,5	1,5		5,77
L 250 08	PL08250	8	250	7	3020	75	146	228	48	52	2	2		7,39
L 280 08	PL08280	8	280	7	3020	75	146	256	48	52	2	2		8,90
L 315 08	PL08315	8	315	7	3020	75	146	285	48	52	2	2		11,30



PULEGGE SCANALATE POLY-V PER BUSSOLA CONICA POLY-V PULLEYS FOR TAPER BUSH

Sezione L 12 GOLE

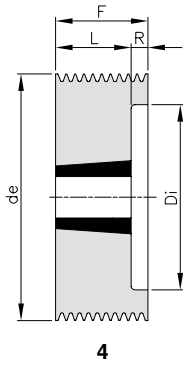

4

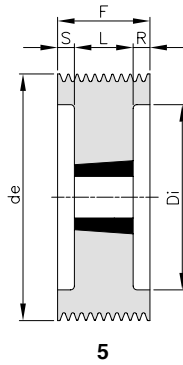

5

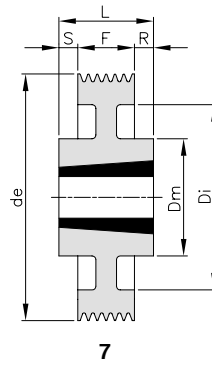

7

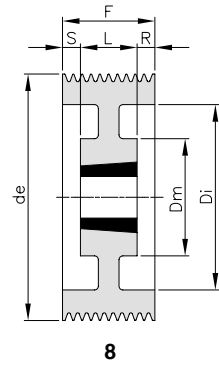

8

Materiale: GHISA EN-GJL-200

descrizione	codice	gole	de	tipo	bussola	foro max	Dm	Di	F	L	R	S	d	Kg.
L 75 12	PL12075	12	75	4	1215	32		56	67	42	25			0,97
L 80 12	PL12080	12	80	4	1215	32		56	67	42	25			1,25
L 85 12	PL12085	12	85	4	1215	32		61	67	42	25			1,47
L 90 12	PL12090	12	90	4	1615	42		66	67	42	25			1,45
L 95 12	PL12095	12	95	4	1615	42		71	67	42	25			1,71
L 100 12	PL12100	12	100	4	2012	50		79	67	32	35			1,39
L 106 12	PL12106	12	106	4	2012	50		82	67	32	35			1,73
L 112 12	PL12112	12	112	4	2012	50		88	67	32	35			2,02
L 118 12	PL12118	12	118	5	2517	65		97	67	45	11	11		1,96
L 125 12	PL12125	12	125	5	2517	65		101	67	45	11	11		2,46
L 132 12	PL12132	12	132	5	2517	65		108	67	45	11	11		2,97
L 140 12	PL12140	12	140	5	2517	65		116	67	45	11	11		3,55
L 150 12	PL12150	12	150	5	2517	65		126	67	45	11	11		4,30
L 160 12	PL12160	12	160	5	2517	65		136	67	45	11	11		5,12
L 170 12	PL12170	12	170	5	2517	65		146	67	45	11	11		6,03
L 180 12	PL12180	12	180	8	2517	65	120	156	67	45	11	11		5,34
L 190 12	PL12190	12	190	8	2517	65	120	166	67	45	11	11		5,60
L 200 12	PL12200	12	200	8	3020	75	146	176	67	52	7,5	7,5		6,99
L 212 12	PL12212	12	212	8	3020	75	146	188	67	52	7,5	7,5		7,06
L 224 12	PL12224	12	224	8	3020	75	146	202	67	52	7,5	7,5		7,41
L 250 12	PL12250	12	250	8	3020	75	146	228	67	52	7,5	7,5		8,67
L 280 12	PL12280	12	280	8	3020	75	146	256	67	52	7,5	7,5		10,58
L 315 12	PL12315	12	315	7	3535	90	178	285	67	89	11	11		18,23



PULEGGE SCANALATE POLY-V PER BUSSOLA CONICA POLY-V PULLEYS FOR TAPER BUSH

Sezione L 16 GOLE

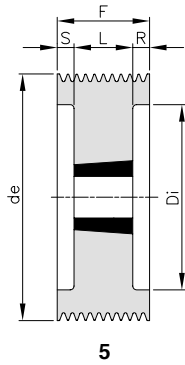

5

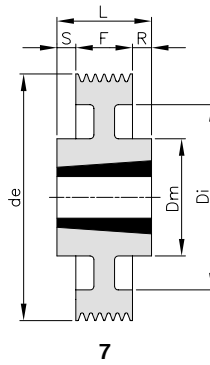

7

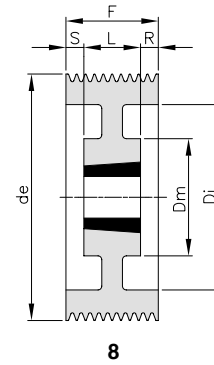

8

Materiale: GHISA EN-GJL-200

descrizione	codice	gole	de	tipo	bussola	foro max	Dm	Di	F	L	R	S	d	Kg.
L 85 16	PL16085	16	85	5	1215	32		61	86	42	22	22		1,76
L 90 16	PL16090	16	90	5	1615	42		66	86	42	22	22		1,78
L 95 16	PL16095	16	95	5	1615	42		71	86	42	22	22		2,02
L 100 16	PL16100	16	100	5	2012	50		79	86	32	27	27		1,69
L 106 16	PL16106	16	106	5	2012	50		82	86	32	27	27		2,12
L 112 16	PL16112	16	112	5	2012	50		88	86	32	27	27		2,42
L 118 16	PL16118	16	118	5	2517	65		97	86	45	20,5	20,5		2,31
L 125 16	PL16125	16	125	5	2517	65		101	86	45	20,5	20,5		2,92
L 132 16	PL16132	16	132	5	2517	65		108	86	45	20,5	20,5		3,44
L 140 16	PL16140	16	140	5	2517	65		116	86	45	20,5	20,5		4,05
L 150 16	PL16150	16	150	5	2517	65		126	86	45	20,5	20,5		4,85
L 160 16	PL16160	16	160	5	3020	75		136	86	52	17	17		4,88
L 170 16	PL16170	16	170	5	3020	75		146	86	52	17	17		5,96
L 180 16	PL16180	16	180	5	3020	75		156	86	52	17	17		7,09
L 190 16	PL16190	16	190	8	3020	75	146	166	86	52	17	17		8,20
L 200 16	PL16200	16	200	8	3020	75	146	176	86	52	17	17		7,92
L 212 16	PL16212	16	212	8	3020	75	146	188	86	52	17	17		8,03
L 224 16	PL16224	16	224	8	3020	75	146	202	86	52	17	17		8,42
L 250 16	PL16250	16	250	7	3535	90	178	228	86	89	1,5	1,5		16,09
L 280 16	PL16280	16	280	7	3535	90	178	256	86	89	1,5	1,5		17,10
L 315 16	PL16315	16	315	7	3535	90	178	285	86	89	1,5	1,5		20,93

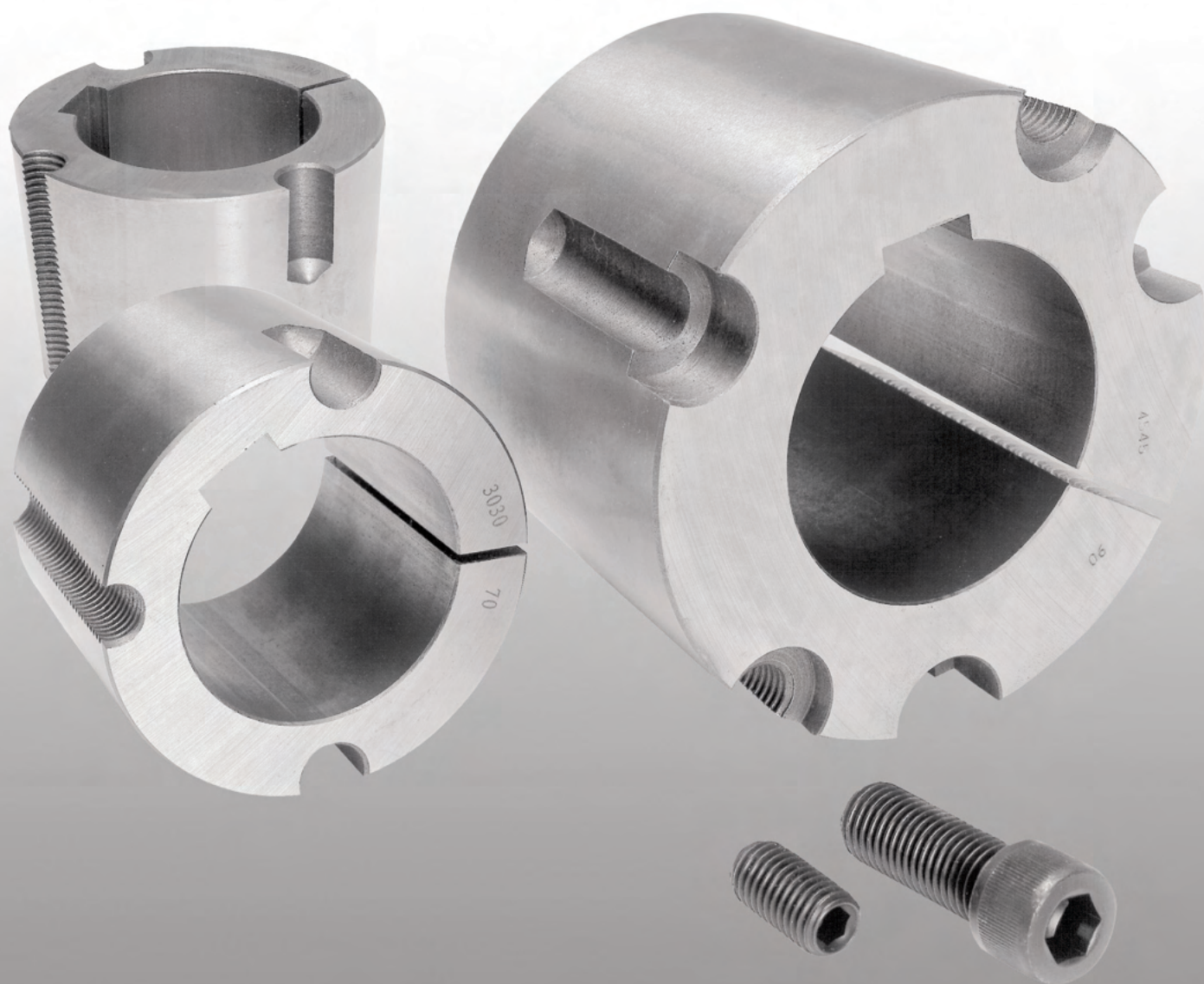



Caratteristiche / Characteristics

Le bussole coniche permettono di allineare o bloccare pulegge, pignoni dentati o giunti all'albero di trasmissione in modo rapido e senza l'utilizzo di attrezzature. Le bussole sono complete di alesaggio e cava per chiavetta.

La bussola conica elastica permette un recupero delle tolleranze.

E' possibile riutilizzare una bussola dopo un rimpiazzo.

The taper bushes allows to align or to lock pulleys, sprockets or toothed couplings to a transmission shaft, quickly and without the use of equipment.

The taper bushes is equipped of bore and keyway.

The taper bushes allows an elastic recovery of tolerances and can be re-used after a replacement.

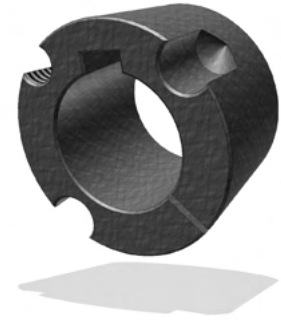

Montaggio / Assembly

Assicurarsi che le superfici coniche siano pulite, prive di olii o polveri.

Inserire la bussola nella ruota in modo da allineare i fori.

Make sure that the tapered surfaces are clean, free of oils or powders.

Place the bushes in the wheel so as to align the holes.

Posizionare le viti nei fori filettati, senza stringerle.

Pulire l'albero e quindi montarvi ruota e bussola, ricordando che la bussola stringe prima l'albero e poi la ruota.

Place the screws into the threaded holes, loosely.

Clean the transmission shaft and then mount the wheel and the bushes, pointing out that the bushes holds the transmission shaft first and then the wheel.

Con una chiave esagonale stringere le viti gradualmente ed in modo alternato.

Verificare la chiusura delle viti dopo un breve periodo di funzionamento.

With a hex key tighten the screws gradually and alternately.

Check the closing of the screws after a short period of operation.



Smontaggio / Disassembly

Allentare tutte le viti e rimuoverne una o due in base ai fori di smontaggio.

Inserire le viti nei fori di smontaggio ed avvitarle in modo alternato fino all'allentamento della bussola e fintanto che il gruppo non sia libero sull'albero.

Rimuovere la bussola e la ruota dall'albero.

Loosen all the screws and remove one or two screws depending on the holes of the disassembly.

Insert the screws into the holes for dismantling. Tighten the screws alternately until the relaxation of the bushes. Continue until the group is not free on the transmission shaft.

Remove the bushes and the wheel from the transmission shaft.

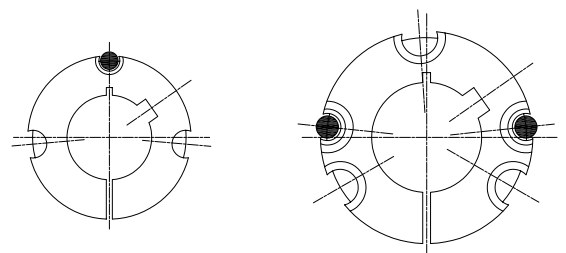

● FORI DI SMONTAGGIO



BUSSOLE CONICHE DI SERRAGGIO TAPER BUSHES

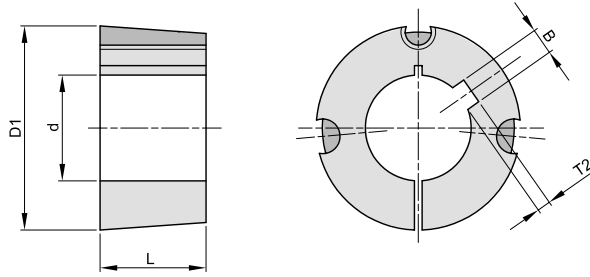

BUSSOLA 1008

Diametro maggiore (D1) = 35
Lunghezza (L) = 22,3

Viti BSW = 1/4"
Coppia di serraggio = 5,6 Nm

diam. fori d	codice	largh. cava B	prof. cava T2	Kg.
10	391008010	3	1,4	0,13
11	391008011	4	1,8	0,13
12	391008012	4	1,8	0,12
14	391008014	5	2,3	0,12
15	391008015	5	2,3	0,11
16	391008016	5	2,3	0,11
18	391008018	6	2,8	0,10
19	391008019	6	2,8	0,10
20	391008020	6	2,8	0,09
22	391008022	6	2,8	0,08
24	391008024	8	1,3	0,07
25	391008025	8	1,3	0,07

BUSSOLA 1108

Diametro maggiore (D1) = 38
Lunghezza (L) = 22,3

Viti BSW = 1/4"
Coppia di serraggio = 5,6 Nm

diam. fori d	codice	largh. cava B	prof. cava T2	Kg.
11	391108011	4	1,8	0,16
12	391108012	4	1,8	0,15
14	391108014	5	2,3	0,15
15	391108015	5	2,3	0,14
16	391108016	5	2,3	0,14
18	391108018	6	2,8	0,13
19	391108019	6	2,8	0,13
20	391108020	6	2,8	0,12
22	391108022	6	2,8	0,11
24	391108024	8	3,3	0,10
25	391108025	8	3,3	0,09
28	391108028	8	1,3	0,07

BUSSOLA 1210

Diametro maggiore (D1) = 47
Lunghezza (L) = 25,4

Viti BSW = 3/8"
Coppia di serraggio = 20 Nm

diam. fori d	codice	largh. cava B	prof. cava T2	Kg.
11	391210011	4	1,8	0,28
12	391210012	4	1,8	0,28
14	391210014	5	2,3	0,27
15	391210015	5	2,3	0,26
16	391210016	5	2,3	0,26
18	391210018	6	2,8	0,25
19	391210019	6	2,8	0,24
20	391210020	6	2,8	0,24
22	391210022	6	2,8	0,22
24	391210024	8	3,3	0,21
25	391210025	8	3,3	0,21
28	391210028	8	3,3	0,18
30	391210030	8	3,3	0,17
32	391210032	10	3,3	0,15

BUSSOLA 1215

Diametro maggiore (D1) = 47
Lunghezza (L) = 38,1

Viti BSW = 3/8"
Coppia di serraggio = 20 Nm

diam. fori d	codice	largh. cava B	prof. cava T2	Kg.
12	391215012	4	1,8	0,39
14	391215014	5	2,3	0,38
16	391215016	5	2,3	0,37
18	391215018	6	2,8	0,35
19	391215019	6	2,8	0,34
20	391215020	6	2,8	0,34
22	391215022	6	2,8	0,32
24	391215024	8	3,3	0,29
25	391215025	8	3,3	0,29
28	391215028	8	3,3	0,26
30	391215030	8	3,3	0,23
32	391215032	10	3,3	0,20



BUSSOLE CONICHE DI SERRAGGIO TAPER BUSHES

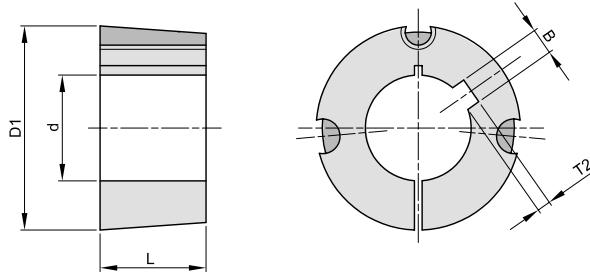

BUSSOLA 1610

Diametro maggiore (D1) = 57
Lunghezza (L) = 25,4

Viti BSW = 3/8"
Coppia di serraggio = 20 Nm

diam. fori d	codice	largh. cava B	prof. cava T2	Kg.
12	391610012	4	1,8	0,41
14	391610014	5	2,3	0,41
15	391610015	5	2,3	0,40
16	391610016	5	2,3	0,40
18	391610018	6	2,8	0,39
19	391610019	6	2,8	0,38
20	391610020	6	2,8	0,38
22	391610022	6	2,8	0,37
24	391610024	8	3,3	0,36
25	391610025	8	3,3	0,35
28	391610028	8	3,3	0,32
30	391610030	8	3,3	0,30
32	391610032	10	3,3	0,29
35	391610035	10	3,3	0,26
38	391610038	10	3,3	0,23
40	391610040	12	3,3	0,21
42	391610042	12	3,3	0,19

BUSSOLA 1615

Diametro maggiore (D1) = 57
Lunghezza (L) = 38,1

Viti BSW = 3/8"
Coppia di serraggio = 20 Nm

diam. fori d	codice	largh. cava B	prof. cava T2	Kg.
12	391615012	4	1,8	0,60
14	391615014	5	2,3	0,58
16	391615016	5	2,3	0,58
18	391615018	6	2,8	0,56
19	391615019	6	2,8	0,55
20	391615020	6	2,8	0,55
22	391615022	6	2,8	0,53
24	391615024	8	3,3	0,50
25	391615025	8	3,3	0,49
28	391615028	8	3,3	0,47
30	391615030	8	3,3	0,45
32	391615032	10	3,3	0,41
35	391615035	10	3,3	0,38
38	391615038	10	3,3	0,32
40	391615040	12	3,3	0,29
42	391615042	12	2,2	0,26

BUSSOLA 2012

Diametro maggiore (D1) = 70
Lunghezza (L) = 31,8

Viti BSW = 7/16"
Coppia di serraggio = 31 Nm

diam. fori d	codice	largh. cava B	prof. cava T2	Kg.
15	392012015	5	2,3	0,78
16	392012016	5	2,3	0,78
18	392012018	6	2,8	0,76
19	392012019	6	2,8	0,76
20	392012020	6	2,8	0,75
22	392012022	6	2,8	0,74
24	392012024	8	3,3	0,72
25	392012025	8	3,3	0,71
28	392012028	8	3,3	0,68
30	392012030	8	3,3	0,66
32	392012032	10	3,3	0,64
35	392012035	10	3,3	0,60
38	392012038	10	3,3	0,57
40	392012040	12	3,3	0,54
42	392012042	12	3,3	0,51
45	392012045	14	3,8	0,46
48	392012048	14	3,8	0,40
50	392012050	14	3,8	0,37

BUSSOLA 2517

Diametro maggiore (D1) = 85
Lunghezza (L) = 44,5

Viti BSW = 1/2"
Coppia di serraggio = 48 Nm

diam. fori d	codice	largh. cava B	prof. cava T2	Kg.
15	392517015	5	2,3	1,65
18	392517018	6	2,8	1,62
19	392517019	6	2,8	1,62
20	392517020	6	2,8	1,60
22	392517022	6	2,8	1,57
24	392517024	8	3,3	1,57
25	392517025	8	3,3	1,56
28	392517028	8	3,3	1,52
30	392517030	8	3,3	1,49
32	392517032	10	3,3	1,45
35	392517035	10	3,3	1,40
38	392517038	10	3,3	1,40
40	392517040	12	3,3	1,35
42	392517042	12	3,3	1,27
45	392517045	14	3,8	1,20
48	392517048	14	3,8	1,13
50	392517050	14	3,8	1,08
55	392517055	16	4,3	0,96
60	392517060	18	4,4	0,81
65	392517065	18	3,3	0,65



BUSSOLE CONICHE DI SERRAGGIO TAPER BUSHES

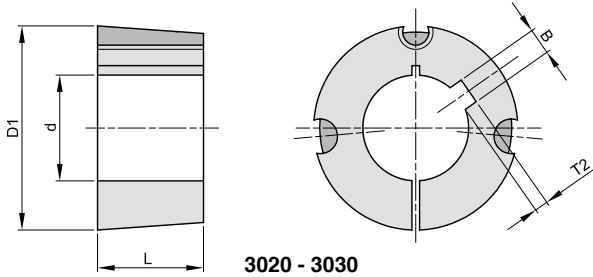

3020 - 3030

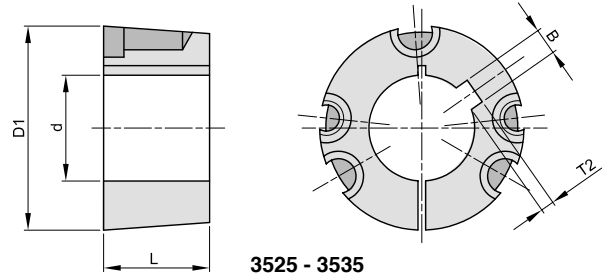

3525 - 3535

BUSSOLA 3020

Diametro maggiore (D1) = 108
Lunghezza (L) = 50,8

Viti BSW = 5/8"
Coppia di serraggio = 90 Nm

diam. fori d	codice	largh. cava B	prof. cava T2	Kg.
20	393020020	6	2,8	2,98
25	393020025	8	3,3	2,91
28	393020028	8	3,3	2,79
30	393020030	8	3,3	2,84
32	393020032	10	3,3	2,80
35	393020035	10	3,3	2,75
38	393020038	10	3,3	2,67
40	393020040	12	3,3	2,64
42	393020042	12	3,3	2,59
45	393020045	14	3,8	2,52
48	393020048	14	3,8	2,43
50	393020050	14	3,8	2,37
55	393020055	16	4,3	2,23
60	393020060	18	4,4	2,07
65	393020065	18	4,4	1,89
70	393020070	20	4,9	1,69
75	393020075	20	4,9	1,49

BUSSOLA 3030

Diametro maggiore (D1) = 108
Lunghezza (L) = 76,2

Viti BSW = 5/8"
Coppia di serraggio = 90 Nm

diam. fori d	codice	largh. cava B	prof. cava T2	Kg.
30	393030030	8	3,3	4,10
35	393030035	10	3,3	3,95
38	393030038	10	3,3	3,86
40	393030040	12	3,3	3,82
42	393030042	12	3,3	3,69
45	393030045	14	3,8	3,55
48	393030048	14	3,8	3,45
50	393030050	14	3,8	3,42
55	393030055	16	4,3	3,18
60	393030060	18	4,4	2,95
65	393030065	18	4,4	2,68
70	393030070	20	4,9	2,38
75	393030075	20	4,9	2,03

BUSSOLA 3525

Diametro maggiore (D1) = 127
Lunghezza (L) = 63,5

Viti BSW = 1/2"
Coppia di serraggio = 112 Nm

diam. fori d	codice	largh. cava B	prof. cava T2	Kg.
30	393525030	8	3,3	5,02
35	393525035	10	3,3	4,91
38	393525038	10	3,3	4,85
40	393525040	12	3,3	4,80
42	393525042	12	3,3	4,71
45	393525045	14	3,8	4,67
48	393525048	14	3,8	4,55
50	393525050	14	3,8	4,44
55	393525055	16	4,3	4,29
60	393525060	18	4,4	4,05
65	393525065	18	4,4	3,88
70	393525070	20	4,9	3,58
75	393525075	20	4,9	3,37
80	393525080	22	5,4	3,05
85	393525085	22	5,4	2,77
90	393525090	25	5,4	2,47

BUSSOLA 3535

Diametro maggiore (D1) = 127
Lunghezza (L) = 89

Viti BSW = 1/2"
Coppia di serraggio = 112 Nm

diam. fori d	codice	largh. cava B	prof. cava T2	Kg.
30	393535030	8	3,3	6,84
35	393535035	10	3,3	6,70
38	393535038	10	3,3	6,53
40	393535040	12	3,3	6,48
42	393535042	12	3,3	6,40
45	393535045	14	3,8	6,25
48	393535048	14	3,8	6,17
50	393535050	14	3,8	6,05
55	393535055	16	4,3	5,81
60	393535060	18	4,4	5,50
65	393535065	18	4,4	5,20
70	393535070	20	4,9	4,88
75	393535075	20	4,9	4,46
80	393535080	22	5,4	4,08
85	393535085	22	5,4	3,67
90	393535090	25	5,4	3,21



BUSSOLE CONICHE DI SERRAGGIO TAPER BUSHES

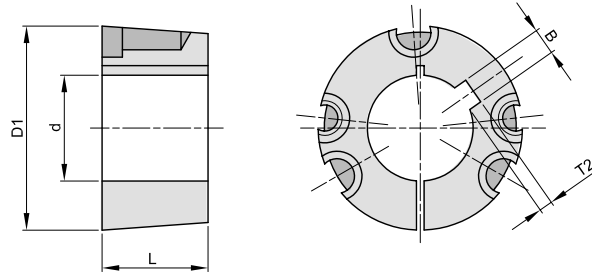

BUSSOLA 4030

Diametro maggiore (D1) = 146 Viti BSW = 5/8"
Lunghezza (L) = 76,2 Coppia di serraggio = 170 Nm

diam. fori d	codice	largh. cava B	prof. cava T2	Kg.
40	394030040	12	3,3	6,65
42	394030042	12	3,3	6,58
45	394030045	14	3,8	6,58
48	394030048	14	3,8	6,55
50	394030050	14	3,8	6,40
55	394030055	16	4,3	6,40
60	394030060	18	4,4	6,35
65	394030065	18	4,4	6,35
70	394030070	20	4,9	6,30
75	394030075	20	4,9	6,30
80	394030080	22	5,4	6,10
85	394030085	22	5,4	6,10
90	394030090	25	5,4	5,90

BUSSOLA 4040

Diametro maggiore (D1) = 146 Viti BSW = 5/8"
Lunghezza (L) = 101,5 Coppia di serraggio = 170 Nm

diam. fori d	codice	largh. cava B	prof. cava T2	Kg.
45	394040045	14	3,8	9,86
48	394040048	14	3,8	9,66
50	394040050	14	3,8	9,48
55	394040055	16	4,3	9,27
60	394040060	18	4,4	8,93
65	394040065	18	4,4	8,65
70	394040070	20	4,9	8,17
75	394040075	20	4,9	7,78
80	394040080	22	5,4	7,35
85	394040085	22	5,4	6,89
90	394040090	25	5,4	6,36
95	394040095	25	5,4	5,94
100	394040100	28	6,4	5,27

BUSSOLA 4535

Diametro maggiore (D1) = 162 Viti BSW = 3/4"
Lunghezza (L) = 89 Coppia di serraggio = 192 Nm

diam. fori d	codice	largh. cava B	prof. cava T2	Kg.
55	394535055	16	4,3	10,55
60	394535060	18	4,4	10,50
65	394535065	18	4,4	10,40
70	394535070	20	4,9	10,20
75	394535075	20	4,9	9,95
80	394535080	22	5,4	9,95
85	394535085	22	5,4	9,90
90	394535090	25	5,4	9,80
95	394535095	25	5,4	9,75
100	394535100	28	6,4	9,65
110	394535110	28	6,4	9,55
120	394535120	32	7,4	9,45

BUSSOLA 4545

Diametro maggiore (D1) = 162 Viti BSW = 3/4"
Lunghezza (L) = 114,3 Coppia di serraggio = 192 Nm

diam. fori d	codice	largh. cava B	prof. cava T2	Kg.
55	394545055	16	4,3	13,15
60	394545060	18	4,4	12,76
65	394545065	18	4,4	12,38
70	394545070	20	4,9	12,02
75	394545075	20	4,9	11,57
80	394545080	22	5,4	11,05
85	394545085	22	5,4	10,46
90	394545090	25	5,4	9,99
95	394545095	25	5,4	9,42
100	394545100	28	6,4	8,63
110	394545110	28	6,4	7,37



BUSSOLE CONICHE DI SERRAGGIO TAPER BUSHES

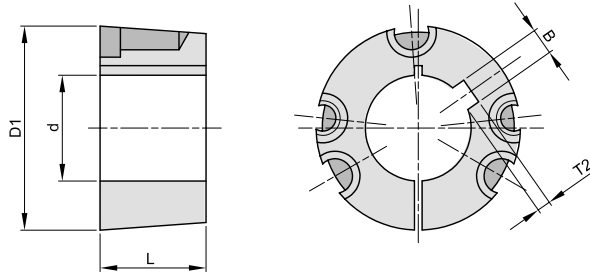

BUSSOLA 5040

Diametro maggiore (D1) = 178 Viti BSW = 7/8"
Lunghezza (L) = 101,6 Coppia di serraggio = 271 Nm

diam. fori d	codice	largh. cava B	prof. cava T2	Kg.
70	395040070	20	4,9	11,90
75	395040075	20	4,9	11,90
80	395040080	22	5,4	11,30
85	395040085	22	5,4	11,30
90	395040090	25	5,4	10,60
100	395040100	28	6,4	10,60
110	395040110	28	6,4	10,00
120	395040120	32	7,4	9,70
125	395040125	32	7,4	9,70

BUSSOLA 5050

Diametro maggiore (D1) = 178 Viti BSW = 7/8"
Lunghezza (L) = 127 Coppia di serraggio = 271 Nm

diam. fori d	codice	largh. cava B	prof. cava T2	Kg.
65	395050065	18	4,4	16,70
70	395050070	20	4,9	16,70
75	395050075	20	4,9	16,05
80	395050080	22	5,4	15,56
85	395050085	22	5,4	15,00
90	395050090	25	5,4	14,43
95	395050095	25	5,4	13,88
100	395050100	28	6,4	13,05
110	395050110	28	6,4	11,56
115	395050115	32	7,4	10,51
120	395050120	32	7,4	9,78
125	395050125	32	7,4	9,05



VITI DI SERRAGGIO PER BUSSOLE CONICHE SCREWS FOR TAPER BUSHES



Viti senza testa con cava esagonale Set screw with internal hexagon

descrizione bussola	codice	Vite di serraggio BSW	Coppia di serraggio Nm	Kg.
1008	399999991	1/4"	5,6	0,002
1108	399999991	1/4"	5,6	0,002
1210	399999992	3/8"	20,0	0,005
1215	399999992	3/8"	20,0	0,005
1610	399999992	3/8"	20,0	0,005
1615	399999992	3/8"	20,0	0,005
2012	399999993	7/16"	31,0	0,012
2517	399999994	1/2"	48,0	0,017
3020	399999995	5/8"	90,0	0,032
3030	399999995	5/8"	90,0	0,032

Viti a testa con cava esagonale Set head screw with internal hexagon

descrizione bussola	codice	Vite di serraggio BSW	Coppia di serraggio Nm	Kg.
3525	399999996	1/2"	112,0	0,050
3535	399999996	1/2"	112,0	0,050
4030	399999997	5/8"	170,0	0,090
4040	399999997	5/8"	170,0	0,090
4535	399999998	3/4"	192,0	0,146
4545	399999998	3/4"	192,0	0,146
5040	399999999	7/8"	271,0	0,228
5050	399999999	7/8"	271,0	0,228





CALETTATORI - DATI TECNICI

LOCKING ASSEMBLIES - TECHNICAL DATA

Calcolo del minimo diametro esterno mozzo (DM)
 Calculation of the minimum outside diameter of hub (DM)

$$DM \geq D \cdot K$$

D = diametro esterno calettatore (mm)
 outside diameter of locking assemle (mm)
K = coefficiente (vedi tabella)
 coefficient (see table)

Per il calcolo del valore K, non riportato in tabella applicare la seguente formula:
 To calculate the "K" value not shown in the table, use the following formula:

$$K = \sqrt{\frac{\sigma_{0,2} + (C \cdot PN)}{\sigma_{0,2} - (C \cdot PN)}} \text{ (mm)}$$

$\sigma_{0,2}$ = **carico di snervamento del materiale (N/mm²)**
 yield strength of the material (N/mm²)
C = fattore in funzione del tipo di applicazione
 factor depending on the type of the application
PN = pressione superficiale del mozzo
 surface pressure of the hub



TABELLA DEL COEFFICIENTE "K" - COEFFICIENT "K" TABLE

	GG-20	GG-30 GTS-35 ALSi1MgMn	GGG-38 GS-400 St.42-3	GGG-50 GS-500 C-40	GGG-60 GS-600 C-45	GGG-70 GS-70 C-60	
--	-------	------------------------------	-----------------------------	--------------------------	--------------------------	-------------------------	--

valori indicativi per il carico di snervamento $\sigma_{0,2}$ in N/mm²

pn N/mm ²	150			200			250			300			350			400			450			600		
	0,6	0,8	1	0,6	0,8	1	0,6	0,8	1	0,6	0,8	1	0,6	0,8	1	0,6	0,8	1	0,6	0,8	1	0,6	0,8	1
60	1,28	1,39	1,53	1,20	1,28	1,36	1,16	1,21	1,28	1,13	1,18	1,22	1,11	1,15	1,19	1,09	1,13	1,16	1,08	1,11	1,14	1,06	1,08	1,11
65	1,30	1,44	1,59	1,22	1,30	1,40	1,17	1,24	1,30	1,14	1,19	1,25	1,12	1,16	1,21	1,10	1,14	1,18	1,09	1,12	1,16	1,07	1,09	1,11
70	1,33	1,48	1,66	1,24	1,33	1,44	1,18	1,26	1,33	1,15	1,21	1,27	1,13	1,18	1,22	1,11	1,15	1,19	1,10	1,13	1,17	1,07	1,10	1,12
75	1,36	1,53	1,73	1,26	1,36	1,48	1,20	1,28	1,36	1,16	1,22	1,29	1,14	1,19	1,24	1,12	1,16	1,21	1,11	1,14	1,18	1,08	1,11	1,13
80	1,39	1,58	1,81	1,28	1,39	1,53	1,21	1,30	1,39	1,18	1,24	1,31	1,15	1,20	1,26	1,13	1,18	1,22	1,11	1,15	1,20	1,08	1,11	1,14
85	1,42	1,63	1,90	1,30	1,42	1,57	1,23	1,32	1,42	1,19	1,26	1,34	1,16	1,22	1,28	1,14	1,19	1,24	1,12	1,16	1,21	1,09	1,12	1,15
90	1,46	1,69	2,00	1,32	1,46	1,62	1,25	1,34	1,46	1,20	1,28	1,36	1,17	1,23	1,30	1,15	1,20	1,26	1,13	1,18	1,22	1,09	1,13	1,16
95	1,49	1,75	2,11	1,34	1,49	1,68	1,26	1,37	1,49	1,21	1,30	1,39	1,18	1,25	1,32	1,15	1,21	1,27	1,14	1,19	1,24	1,10	1,14	1,17
100	1,53	1,81	2,24	1,36	1,53	1,73	1,28	1,39	1,53	1,22	1,31	1,41	1,19	1,26	1,34	1,16	1,22	1,29	1,14	1,20	1,25	1,11	1,14	1,18
105	1,56	1,88	2,38	1,39	1,56	1,79	1,29	1,42	1,56	1,24	1,23	1,44	1,20	1,28	1,36	1,17	1,24	1,31	1,15	1,21	1,27	1,11	1,15	1,19
110	1,60	1,96	2,55	1,41	1,60	1,86	1,31	1,44	1,60	1,25	1,35	1,47	1,21	1,29	1,38	1,18	1,25	1,33	1,16	1,22	1,28	1,12	1,16	1,20
115	1,64	2,04	2,75	1,43	1,64	1,93	1,33	1,47	1,64	1,26	1,37	1,50	1,22	1,31	1,41	1,19	1,26	1,34	1,17	1,23	1,30	1,12	1,17	1,21
120	1,69	2,13	3,00	1,46	1,69	2,00	1,34	1,50	1,69	1,28	1,39	1,53	1,23	1,33	1,43	1,20	1,28	1,36	1,18	1,24	1,31	1,13	1,18	1,22
125	1,73	2,24	3,32	1,48	1,73	2,08	1,36	1,53	1,73	1,29	1,41	1,56	1,24	1,34	1,45	1,21	1,29	1,38	1,18	1,25	1,33	1,13	1,18	1,24
130	1,78	2,35	3,74	1,51	1,78	2,17	1,38	1,56	1,78	1,30	1,44	1,59	1,25	1,36	1,48	1,22	1,30	1,40	1,19	1,27	1,35	1,14	1,19	1,25
135	1,83	2,48	4,36	1,54	1,83	2,27	1,40	1,59	1,83	1,32	1,46	1,62	1,27	1,38	1,50	1,23	1,32	1,42	1,20	1,28	1,36	1,15	1,20	1,26
140	1,88	2,63	5,39	1,56	1,88	2,38	1,42	1,62	1,88	1,33	1,48	1,66	1,28	1,39	1,53	1,24	1,33	1,44	1,21	1,29	1,38	1,15	1,21	1,27
145	1,94	2,80	7,68	1,59	1,94	2,50	1,44	1,65	1,94	1,35	1,50	1,69	1,29	1,41	1,55	1,25	1,35	1,46	1,22	1,30	1,40	1,16	1,22	1,28
150	2,00	3,00		1,62	2,00	2,65	1,46	1,69	2,00	1,36	1,53	1,73	1,30	1,43	1,58	1,26	1,36	1,48	1,22	1,31	1,41	1,16	1,22	1,29
155	2,06	3,25		1,65	2,06	2,81	1,48	1,72	2,06	1,38	1,55	1,77	1,31	1,45	1,61	1,27	1,38	1,51	1,23	1,33	1,43	1,17	1,23	1,30
160	2,13	3,55		1,69	2,13	3,00	1,50	1,76	2,13	1,39	1,58	1,81	1,33	1,47	1,64	1,28	1,39	1,53	1,24	1,34	1,45	1,18	1,24	1,31
165	2,21	3,96		1,72	2,21	3,23	1,52	1,80	2,21	1,41	1,60	1,86	1,34	1,49	1,67	1,29	1,41	1,55	1,25	1,35	1,47	1,18	1,25	1,33
170	2,29	4,52		1,76	2,29	3,51	1,54	1,84	2,29	1,42	1,63	1,90	1,35	1,51	1,70	1,30	1,42	1,57	1,26	1,37	1,49	1,19	1,26	1,34
180	2,40	7,00		1,83	2,48	4,36	1,59	1,93	2,48	1,46	1,69	2,00	1,38	1,55	1,77	1,32	1,46	1,62	1,28	1,39	1,53	1,20	1,28	1,36
190	2,71			1,91	2,71	6,24	1,64	2,03	2,71	1,49	1,75	2,11	1,40	1,59	1,84	1,34	1,49	1,68	1,30	1,42	1,57	1,21	1,30	1,39
200	3,00			2,00	3,00		1,69	2,13	3,00	1,53	1,81	2,24	1,43	1,64	1,91	1,36	1,53	1,73	1,31	1,45	1,61	1,22	1,31	1,41
210	3,39			2,10	3,39		1,74	2,26	3,39	1,56	1,88	2,38	1,46	1,69	2,00	1,39	1,56	1,79	1,33	1,48	1,66	1,24	1,33	1,44
220	3,96			2,21	3,96		1,80	2,40	3,96	1,60	1,96	2,55	1,49	1,74	2,09	1,41	1,60	1,86	1,35	1,51	1,71	1,25	1,35	1,47
230	4,90			2,33	4,90		1,86	2,56	4,90	1,64	2,04	2,75	1,52	1,79	2,20	1,43	1,64	1,93	1,37	1,54	1,76	1,26	1,37	1,50
240	7,00			2,48	7,00		1,93	2,76	7,00	1,69	2,13	3,00	1,55	1,85	2,32	1,46	1,69	2,00	1,39	1,58	1,81	1,28	1,39	1,53
250				2,65			2,00	3,00		1,73	2,24	3,32	1,58	1,91	2,45	1,48	1,73	2,08	1,41	1,61	1,87	1,29	1,41	1,56
300				4,36			2,48	7,00		2,00	3,00		1,77	2,32	3,61	1,62	2,00	2,65	1,53	1,81	2,24	1,36	1,53	1,73

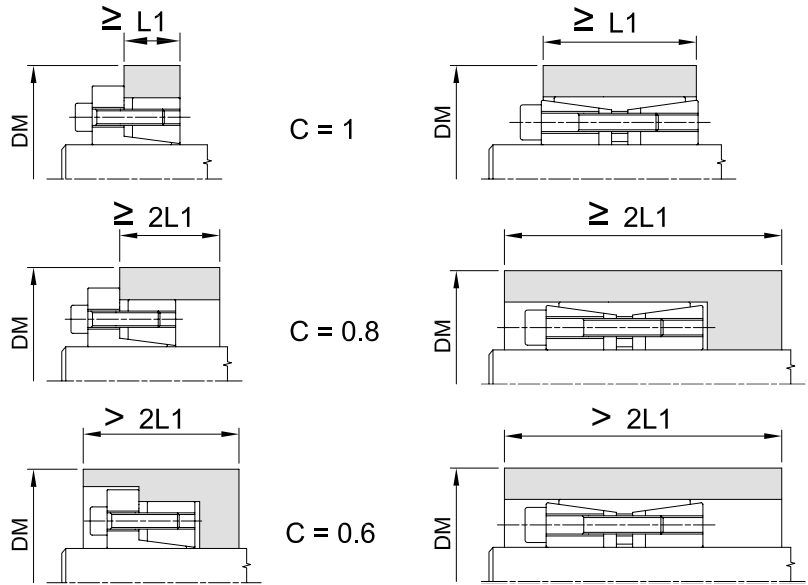

CALETTATORI AUTOCENTRANTI "BK 11" LOCKING ASSEMBLIES SELF-CENTERING "BK 11"

Autocentrante

Momenti torcenti molto elevati

Tolleranze: albero h8 - mozzo H8

Superfici di contatto con rugosità: R_a max 16 μm

Errore di concentricità: $0,02 \pm 0,04$ mm

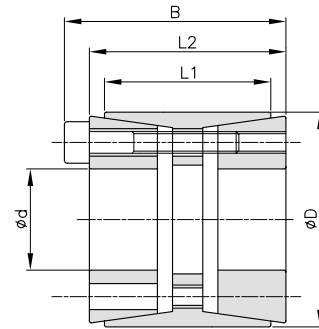
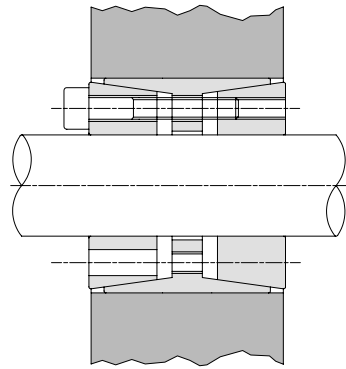

d x D mm	codice	L1 mm	L2 mm	B mm	momento torcente Mt Nm	forza assiale F ass. KN	pressione superficiale		viti di serraggio			Kg.
							albero pw N/mm ²	mozzo pn N/mm ²	DIN 912 12,9 N°	coppia di serraggio Ms Nm	tipo	
25 x 55	BK011025055	32	40	46	799	64	314	107	6	M6x35	17	0,50
28 x 55	BK011028055	32	40	46	895	64	281	107	6	M6x35	17	0,60
30 x 55	BK011030055	32	40	46	959	64	262	107	6	M6x35	17	0,42
35 x 60	BK011035060	44	54	60	1306	75	185	83	7	M6x45	17	0,70
38 x 75	BK011038075	44	54	62	2567	135	308	121	7	M8x50	41	0,70
40 x 75	BK011040075	44	54	62	2702	135	293	121	7	M8x50	41	1,04
42 x 75	BK011042075	44	54	62	2837	135	279	121	7	M8x50	41	1,00
45 x 75	BK011045075	44	54	62	3040	135	260	121	7	M8x50	41	0,90
48 x 80	BK011048080	56	64	72	3707	154	216	102	8	M8x55	41	1,40
50 x 80	BK011050080	56	64	72	3861	154	207	102	8	M8x55	41	1,30
55 x 85	BK011055085	56	64	72	4779	174	212	108	9	M8x55	41	1,34
60 x 90	BK011060090	56	64	72	5793	193	216	113	10	M8x55	41	1,60
65 x 95	BK011065095	56	64	72	6276	193	199	107	10	M8x55	41	1,80
70 x 110	BK011070110	70	78	88	10951	313	235	120	10	M10x60	83	3,00
75 x 115	BK011075115	70	78	88	11733	313	220	115	10	M10x60	83	3,30
80 x 120	BK011080120	70	78	88	13768	344	227	121	11	M10x60	83	3,50
85 x 125	BK011085125	70	78	88	15959	376	233	127	12	M10x60	83	3,70
90 x 130	BK011090130	70	78	88	16898	376	220	122	12	M10x60	83	3,80
95 x 135	BK011095135	70	78	88	17837	376	208	117	12	M10x60	83	5,00
100 x 145	BK011100145	90	100	112	25029	501	211	113	11	M12x80	145	6,00
110 x 155	BK011110155	90	100	112	30039	546	209	115	12	M12x80	145	6,20
120 x 165	BK011120165	90	100	112	38226	637	224	127	14	M12x80	145	7,20
130 x 180	BK011130180	104	116	130	48270	743	201	117	12	M14x90	230	10,00
140 x 190	BK011140190	104	116	130	60654	866	217	129	14	M14x90	230	10,20
150 x 200	BK011150200	104	116	130	69628	928	217	132	15	M14x90	230	10,80
160 x 210	BK011160210	104	116	130	79220	990	217	134	16	M14x90	230	11,50
170 x 225	BK011170225	134	148	164	100851	1186	206	116	14	M16x110	360	17,00
180 x 235	BK011180235	134	148	164	114414	1271	208	119	15	M16x110	360	17,05
190 x 250	BK011190250	134	148	164	128814	1356	210	119	16	M16x110	360	21,50
200 x 260	BK011200260	134	148	164	135594	1356	200	115	16	M16x110	360	22,00
220 x 285	BK011220285	134	148	164	167805	1526	204	118	18	M16x110	360	25,00



CALETTATORI AUTOCENTRANTI "BK 13" LOCKING ASSEMBLIES SELF-CENTERING "BK 13"

Autocentrante

Momenti torcenti medio elevati

Tolleranze: albero h8 - mozzo H8

Superfici di contatto con rugosità: R_a max 16 μ m

Errore di concentricità: 0,02 mm \div 0,04mm

Tempi di montaggio contenuti

☐ Durante il montaggio si può verificare un leggero spostamento assiale del mozzo rispetto all'albero

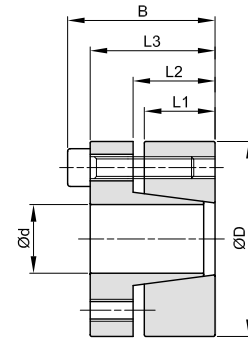
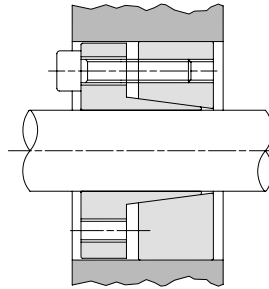

d x D mm	codice	L1 mm	L2 mm	L3 mm	B mm	momento torcente Mt Nm	forza assiale F ass. KN	pressione superficiale		viti di serraggio			Kg.
								albero	mozzo	DIN 912 12,9	coppia di serraggio		
								pw N/mm ²	pn N/mm ²	N°	tipo	Ms Nm	
18 x 47	BK013018047	17	22	28	34	259	29	276	106	5	M6x20	13	0,30
19 x 47	BK013019047	17	22	28	34	273	29	262	106	5	M6x20	13	0,30
20 x 47	BK013020047	17	22	28	34	287	29	249	106	5	M6x20	13	0,30
22 x 47	BK013022047	17	22	28	34	316	29	227	106	5	M6x20	13	0,30
24 x 50	BK013024050	17	22	28	34	413	34	249	120	6	M6x20	13	0,30
25 x 50	BK013025050	17	22	28	34	431	34	239	120	6	M6x20	13	0,30
28 x 55	BK013028055	17	22	28	34	482	34	213	109	6	M6x20	13	0,40
30 x 55	BK013030055	17	22	28	34	517	34	199	109	6	M6x20	13	0,30
32 x 60	BK013032060	17	22	28	34	734	46	249	133	8	M6x20	13	0,40
35 x 60	BK013035060	17	22	28	34	803	46	227	133	8	M6x20	13	0,40
38 x 65	BK013038065	17	22	28	34	872	46	210	122	8	M6x20	13	0,40
40 x 65	BK013040065	17	22	28	34	918	46	199	122	8	M6x20	13	0,40
42 x 75	BK013042075	20	25	33	41	1563	74	261	146	7	M8x25	32	0,80
45 x 75	BK013045075	20	25	33	41	1674	74	244	146	7	M8x25	32	0,60
50 x 80	BK013050080	20	25	33	41	1860	74	219	137	7	M8x25	32	0,80
55 x 85	BK013055085	20	25	33	41	2340	85	228	148	8	M8x25	32	0,80
60 x 90	BK013060090	20	25	33	41	2553	85	209	139	8	M8x25	32	0,80
65 x 95	BK013065095	20	25	33	41	3110	96	217	149	9	M8x25	32	0,90
70 x 110	BK013070110	24	30	40	50	4838	138	243	154	8	M10x30	65	1,59
75 x 115	BK013075115	24	30	40	50	5184	138	226	148	8	M10x30	65	1,80
80 x 120	BK013080120	24	30	40	50	5530	138	212	142	8	M10x30	65	1,80
85 x 125	BK013085125	24	30	40	50	6610	156	225	153	9	M10x30	65	2,00
90 x 130	BK013090130	24	30	40	50	6998	156	212	147	9	M10x30	65	2,10
95 x 135	BK013095135	24	30	40	50	8208	173	223	157	10	M10x30	65	2,10
100 x 145	BK013100145	26	32	44	56	9742	195	221	152	8	M12x35	110	2,80
110 x 155	BK013110155	26	32	44	56	10716	195	201	143	8	M12x35	110	3,00
120 x 165	BK013120165	26	32	44	56	13154	219	207	151	9	M12x35	110	3,20
130 x 180	BK013130180	34	40	52	64	18996	292	195	141	12	M12x35	110	4,80
140 x 190	BK013140190	34	40	54	68	20336	291	180	133	9	M14x40	170	5,20
150 x 200	BK013150200	34	40	54	68	24211	323	187	140	10	M14x40	170	5,40
160 x 210	BK013160210	34	40	54	68	28408	355	192	147	11	M14x40	170	5,70
170 x 225	BK013170225	44	50	64	78	32929	387	153	115	12	M14x40	170	8,00
180 x 235	BK013180235	44	50	64	78	34866	387	144	110	12	M14x40	170	8,30



CALETTATORI AUTOCENTRANTI "BK 15"

LOCKING ASSEMBLIES SELF-CENTERING "BK 15"

Autocentrante

Momenti torcenti medio elevati

Tolleranze: albero h8 - mozzo H8

Superfici di contatto con rugosità: R_a max 16 μm

Errore di concentricità: 0,02 mm ÷ 0,04 mm

Tempi di montaggio contenuti

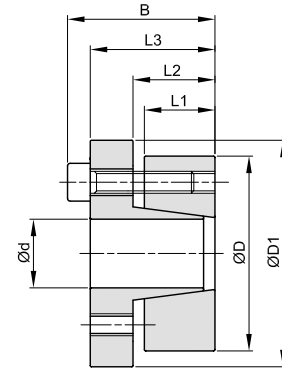
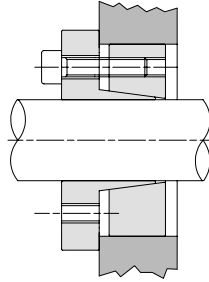

d x D mm	codice	L1 mm	L2 mm	L3 mm	B mm	D1 mm	momento torcente Mt Nm	forza assiale F ass. KN	pressione superficiale		viti di serraggio			Kg.
									albero pw N/mm ²	mozzo pn N/mm ²	DIN 912 12,9 N°	coppia di serraggio Ms Nm	tipo	
14 x 55	BK015014055	17	22	30	38	62	234	37	415	117	4	M8x25	41	0,50
16 x 55	BK015016055	17	22	30	38	62	268	37	363	117	4	M8x25	41	0,50
18 x 55	BK015018055	17	22	30	38	62	333	37	357	117	4	M8x25	41	0,50
19 x 55	BK015019055	17	22	30	38	62	352	37	338	117	4	M8x25	41	0,50
20 x 55	BK015020055	17	22	30	38	62	370	37	321	117	4	M8x25	41	0,50
22 x 55	BK015022055	17	22	30	38	62	407	37	292	117	4	M8x25	41	0,50
24 x 55	BK015024055	17	22	30	38	62	445	37	268	117	4	M8x25	41	0,50
25 x 55	BK015025055	17	22	30	38	62	463	37	257	117	4	M8x25	41	0,50
28 x 55	BK015028055	17	22	30	38	62	519	37	229	117	4	M8x25	41	0,40
30 x 55	BK015030055	17	22	30	38	62	556	37	214	117	4	M8x25	41	0,40
24 x 65	BK015024065	17	22	30	38	72	556	46	335	124	5	M8x25	41	0,70
25 x 65	BK015025065	17	22	30	38	72	579	46	321	124	5	M8x25	41	0,70
28 x 65	BK015028065	17	22	30	38	72	649	46	287	124	5	M8x25	41	0,60
30 x 65	BK015030065	17	22	30	38	72	695	46	268	124	5	M8x25	41	0,60
32 x 65	BK015032065	17	22	30	38	72	741	46	251	124	5	M8x25	41	0,60
35 x 65	BK015035065	17	22	30	38	72	811	46	230	124	5	M8x25	41	0,50
38 x 65	BK015038065	17	22	30	38	72	880	46	211	124	5	M8x25	41	0,50
40 x 65	BK015040065	17	22	30	38	72	927	46	201	124	5	M8x25	41	0,50
30 x 80	BK015030080	20	25	33	41	87	972	65	318	119	7	M8x25	41	1,00
32 x 80	BK015032080	20	25	33	41	87	1037	65	299	119	7	M8x25	41	1,00
35 x 80	BK015035080	20	25	33	41	87	1134	65	273	119	7	M8x25	41	1,00
38 x 80	BK015038080	20	25	33	41	87	1231	65	251	119	7	M8x25	41	1,00
40 x 80	BK015040080	20	25	33	41	87	1296	65	239	119	7	M8x25	41	0,90
42 x 80	BK015042080	20	25	33	41	87	1361	65	227	119	7	M8x25	41	0,90
45 x 80	BK015045080	20	25	33	41	87	1458	65	212	119	7	M8x25	41	0,80
48 x 80	BK015048080	20	25	33	41	87	1555	65	199	119	7	M8x25	41	0,80
50 x 80	BK015050080	20	25	33	41	87	1620	65	191	119	7	M8x25	41	0,80



CALETTATORI AUTOCENTRANTI "BK 16" LOCKING ASSEMBLIES SELF-CENTERING "BK 16"

Autocentrante

Momenti torcenti medio elevati
Tolleranze: albero h8 - mozzo H8
Superfici di contatto con rugosità: R_a max 16 μm
Errore di concentricità: 0,02 mm \div 0,04 mm
Tempi di montaggio contenuti

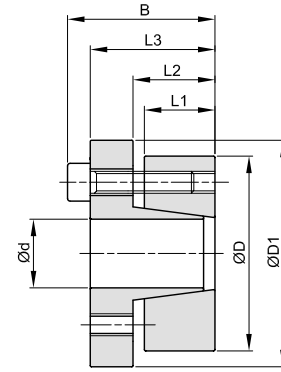
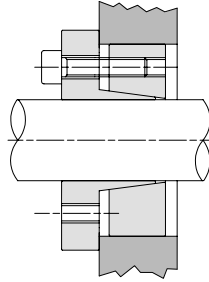

d x D mm	codice	L1 mm	L2 mm	L3 mm	B mm	D1 mm	momento torcente Mt Nm	forza assiale F ass. KN	pressione superficiale		viti di serraggio			Kg.
									albero pw N/mm ²	mozzo pn N/mm ²	DIN 912 12,9 N°	coppia di serraggio Ms Nm	tipo	
18 x 47	BK016018047	17	22	28	34	56	230	26	246	94	5	M6x20	17	0,30
19 x 47	BK016019047	17	22	28	34	56	243	26	234	94	5	M6x20	17	0,30
20 x 47	BK016020047	17	22	28	34	56	256	26	222	94	5	M6x20	17	0,30
22 x 47	BK016022047	17	22	28	34	56	282	26	202	94	5	M6x20	17	0,30
24 x 50	BK016024050	17	22	28	34	59	368	31	222	106	6	M6x20	17	0,30
25 x 50	BK016025050	17	22	28	34	59	383	31	213	106	6	M6x20	17	0,30
28 x 55	BK016028055	17	22	28	34	64	429	31	190	97	6	M6x20	17	0,40
30 x 55	BK016030055	17	22	28	34	64	460	31	177	97	6	M6x20	17	0,40
32 x 60	BK016032060	17	22	28	34	69	655	41	222	118	8	M6x20	17	0,40
35 x 60	BK016035060	17	22	28	34	69	716	41	203	118	8	M6x20	17	0,40
38 x 65	BK016038065	17	22	28	34	74	778	41	187	109	8	M6x20	17	0,50
40 x 65	BK016040065	17	22	28	34	74	819	41	178	109	8	M6x20	17	0,50
42 x 75	BK016042075	20	25	33	41	84	1361	65	227	127	7	M8x25	41	0,80
45 x 75	BK016045075	20	25	33	41	84	1458	65	212	127	7	M8x25	41	0,70
50 x 80	BK016050080	20	25	33	41	89	1620	65	191	119	7	M8x25	41	0,80
55 x 85	BK016055085	20	25	33	41	94	2037	74	199	129	8	M8x25	41	0,90
60 x 90	BK016060090	20	25	33	41	99	2223	74	182	121	8	M8x25	41	0,90
65 x 95	BK016065095	20	25	33	41	104	2710	83	189	126	9	M8x25	41	1,00
70 x 110	BK016070110	24	30	40	50	119	4203	120	211	134	8	M10x30	83	1,90
75 x 115	BK016075115	24	30	40	50	124	4754	120	197	128	8	M10x30	83	1,77
80 x 120	BK016080120	24	30	40	50	129	4804	120	184	123	8	M10x30	83	2,00
85 x 125	BK016085125	24	30	40	50	134	5742	135	195	133	9	M10x30	83	2,00
90 x 130	BK016090130	24	30	40	50	139	6080	135	184	128	9	M10x30	83	2,20
95 x 135	BK016095135	24	30	40	50	144	7131	150	194	137	10	M10x30	83	2,30
100 x 145	BK016100145	26	32	44	56	154	8732	175	198	137	8	M12x35	145	3,00
110 x 155	BK016110155	26	32	44	56	164	9605	175	180	128	8	M12x35	145	3,20
120 x 165	BK016120165	26	32	44	56	174	11787	196	186	135	9	M12x35	145	3,40
130 x 180	BK016130180	34	40	52	64	189	17024	262	175	126	12	M12x35	145	5,20
140 x 190	BK016140190	34	40	54	68	199	18703	267	166	122	9	M14x40	230	5,40
150 x 200	BK016150200	34	40	54	68	209	22259	297	172	129	10	M14x40	230	5,70
160 x 210	BK016160210	34	40	54	68	219	26119	326	177	135	11	M14x40	230	6,00
170 x 225	BK016170225	44	50	64	78	234	30276	356	140	106	12	M14x40	230	8,30
180 x 235	BK016180235	44	50	64	78	244	32057	356	133	102	12	M14x40	230	8,80



CALETTATORI AUTOCENTRANTI "BK 19"

LOCKING ASSEMBLIES SELF-CENTERING "BK 19"

Autocentrante

Momenti torcenti medio elevati

Tolleranze: diametro d h8

Tolleranze: diametro dw

da 18 mm a 30 mm compreso H6/j6

da 30 mm a 50 mm compreso H6/h6

da 50 mm a 80 mm compreso H6/g6

da 80 mm a 500 mm compreso H7/g6

Superfici di contatto con rugosità: R_a max 16 μ m

Tempi di montaggio contenuti

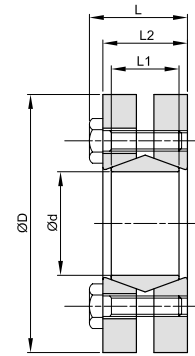
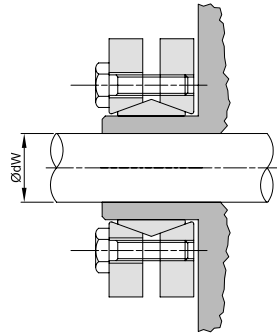

d mm	dw mm	D mm	codice	L1 mm	L2 mm	L mm	pressione superficiale			viti di serraggio			Kg.
							albero	momento torcente	forza assiale	DIN 931 10,9	coppia di serraggio		
							pw N/mm ²	Mt Nm	F ass. KN	N°	tipo	Ms Nm	
24	19	50	BK019024050	14	19,5	23	272	162	15,0	6	M5x18	4,9	0,20
	200							18,5					
	238							21,0					
30	24	60	BK019030060	16	21,5	25	221	285	15,7	7	M5x18	4,9	0,30
	323							23,7					
	361							26,7					
36	28	72	BK019036072	18	23,5	27,5	292	418	27,0	5	M6x20	11,8	0,40
	542							38,0					
	599							43,0					
44	32	80	BK019044080	20	25,5	29,5	301	589	44,0	7	M6x20	11,8	0,60
	741							49,0					
	817							54,0					
50	38	90	BK019050090	22	27,5	31,5	275	893	48,8	8	M6x25	11,8	0,80
	1102							58,8					
	1311							69,0					
55	42	100	BK019055100	23	30,5	34,5	239	1102	48,0	8	M6x25	11,8	1,10
	1444							61,7					
	1786							77,0					
62	48	110	BK019062110	23	30,5	34,5	265	1758	69,0	10	M6x25	11,8	1,30
	2090							80,9					
	2280							90,0					
68	50	115	BK019068115	23	30,5	34,5	242	1900	71,2	10	M6x25	11,8	1,40
	2375							80,9					
	2993							95,7					
75	55	138	BK019075138	25	32,5	37,8	259	2375	94,4	7	M8x30	29,4	1,70
	3040							111,0					
	3753							126,0					
80	60	145	BK019080145	25	32,5	37,8	243	3040	99,3	7	M8x30	29,4	1,90
	3505							115,0					
	4370							130,0					
90	65	155	BK019090155	30	39	44,3	257	4513	141,0	10	M8x35	29,4	3,30
	5700							160,0					
	6888							178,0					
100	70	170	BK019100170	34	44	49,3	245	6555	163,0	12	M8x35	29,4	4,70
	7125							182,0					
	8550							202,0					
110	75	185	BK019110185	39	50	56,4	232	6840	185,0	9	M10x40	57,8	5,90
	8550							207,0					
	10260							221,0					
125	85	215	BK019125215	42	54	60,4	253	10450	240,0	12	M10x40	57,8	8,30
	12350							262,0					
	14250							285,0					
140	95	230	BK019140230	46	60,5	68	251	14345	308,0	10	M12x45	98	10,00
	16720							331,0					
	19095							357,0					
155	105	265	BK019155265	50	64,5	72	250	20900	366,0	12	M12x50	98	15,00
	23750							392,0					
	26600							417,0					
165	115	290	BK019165290	56	71	81	263	29450	513,0	8	M16x55	245	22,00
	33250							544,0					
	37050							564,0					
175	125	300	BK019175300	56	71	81	248	34200	576,0	8	M16x55	250	22,00
	38950							630,0					
	45000							666,0					



CALETTATORI AUTOCENTRANTI "BK 26"

LOCKING ASSEMBLIES SELF-CENTERING "BK 26"

Autocentrante

Momenti torcenti medio bassi

Tolleranze: albero h8 - mozzo H8

Superfici di contatto con rugosità: R_a max 16 μm

Montaggio e smontaggio rapido

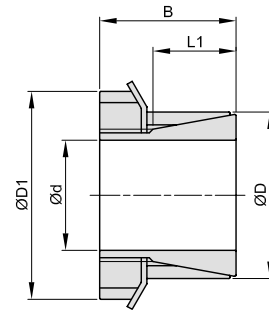
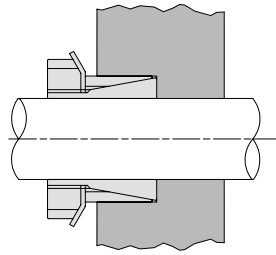

d x D mm	codice	L1 mm	B mm	D1 mm	momento torcente Mt Nm	forza assiale F ass. KN	pressione superficiale		serraggio			Kg.
							albero pw N/mm ²	mozzo pn N/mm ²	ghiera N°	coppia di serraggio Ms Nm	tipo	
14 x 25	BK026014025	20	31	32	70	9	91	55	1	M20x1	95	0,10
15 x 25	BK026015025	20	31	32	77	9	91	55	1	M20x1	95	0,11
18 x 30	BK026018030	21	33	38	125	13	98	59	1	M25x1,5	160	0,13
19 x 30	BK026019030	21	33	38	132	13	93	59	1	M25x1,5	160	0,13
20 x 30	BK026020030	21	33	38	139	13	88	59	1	M25x1,5	160	0,15
24 x 35	BK026024035	25	38	45	202	15	74	51	1	M30x1,5	220	0,17
25 x 35	BK026025035	25	38	45	210	15	71	51	1	M30x1,5	220	0,17
28 x 40	BK026028040	28	44	52	312	20	76	53	1	M35x1,5	340	0,28
30 x 40	BK026030040	28	44	52	335	20	71	53	1	M35x1,5	340	0,26
35 x 45	BK026035045	28	45	58	483	25	75	58	1	M40x1,5	480	0,26
40 x 50	BK026040050	28	46	65	696	31	82	66	1	M45x1,5	680	0,33
45 x 55	BK026045055	28	47	70	902	36	84	69	1	M50x1,5	870	0,45
50 x 60	BK026050060	28	47	75	1014	37	77	64	1	M55x2	970	0,66
55 x 65	BK026055065	28	48	80	1158	38	73	61	1	M60x2	1100	0,72
60 x 70	BK026060070	28	50	85	1379	41	73	62	1	M65x2	1300	0,80



CALETTATORI NON AUTOCENTRANTI "BK 40"

LOCKING ASSEMBLIES NOT SELF-CENTERING "BK 40"

Non Autocentrante

Momenti torcenti medio elevati

Tolleranze: albero h11 - mozzo H11

Superfici di contatto con rugosità: R_a max $16 \mu\text{m}$

Smontaggio rapido

□ Per ottenere una buona concentricità è necessaria una guida tra albero e mozzo

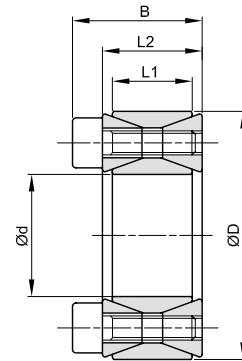
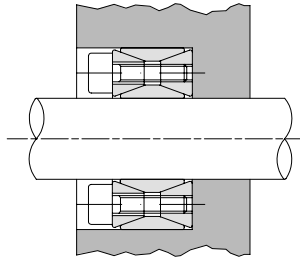

d x D mm	codice	L1 mm	L2 mm	B mm	momento torcente Mt Nm	forza assiale F ass. KN	pressione superficiale		viti di serraggio			Kg.
							albero pw N/mm ²	mozzo pn N/mm ²	DIN 912 12,9 N°	coppia di serraggio Ms Nm	tipo	
19 x 47	BK040019047	17	20	26	298	31	286	116	8	M6x18	14,9	0,25
20 x 47	BK040020047	17	20	26	313	31	272	116	8	M6x18	14,9	0,24
22 x 47	BK040022047	17	20	26	345	31	247	116	8	M6x18	14,9	0,23
24 x 50	BK040024050	17	20	26	424	35	255	123	9	M6x18	14,9	0,26
25 x 50	BK040025050	17	20	26	441	35	245	123	9	M6x18	14,9	0,25
28 x 55	BK040028055	17	20	26	549	39	243	124	10	M6x18	14,9	0,30
30 x 55	BK040030055	17	20	26	588	39	227	124	10	M6x18	14,9	0,29
32 x 60	BK040032060	17	20	26	752	47	255	136	12	M6x18	14,9	0,30
35 x 60	BK040035060	17	20	26	822	47	233	136	12	M6x18	14,9	0,32
38 x 65	BK040038065	17	20	26	1042	55	250	146	14	M6x18	14,9	0,36
40 x 65	BK040040065	17	20	26	1097	55	238	146	14	M6x18	14,9	0,34
42 x 75	BK040042075	20	24	32	1740	83	291	163	12	M8x22	35	0,48
45 x 75	BK040045075	20	24	32	1864	83	271	163	12	M8x22	35	0,57
48 x 80	BK040048080	20	24	32	1988	83	254	153	12	M8x22	35	0,59
50 x 80	BK040050080	20	24	32	2071	83	244	153	12	M8x22	35	0,60
55 x 85	BK040055085	20	24	32	2658	97	259	168	14	M8x22	35	0,63
60 x 90	BK040060090	20	24	32	2900	97	238	158	14	M8x22	35	0,69
65 x 95	BK040065095	20	24	32	3587	110	250	171	16	M8x22	35	0,73
70 x 110	BK040070110	24	28	38	5345	153	268	171	14	M10x25	69	1,26
75 x 115	BK040075115	24	28	38	5727	153	250	163	14	M10x25	69	1,33
80 x 120	BK040080120	24	28	38	6108	153	235	156	14	M10x25	69	1,40
85 x 125	BK040085125	24	28	38	7417	175	252	172	16	M10x25	69	1,49
90 x 130	BK040090130	24	28	38	7854	175	238	165	16	M10x25	69	1,53
95 x 135	BK040095135	24	28	38	9326	196	254	179	18	M10x25	69	1,62
100 x 145	BK040100145	26	33	45	11362	227	258	178	14	M12x30	123,3	2,01
110 x 155	BK040110155	26	33	45	12498	227	234	166	14	M12x30	123,3	2,15
120 x 165	BK040120165	26	33	45	15578	260	245	178	16	M12x30	123,3	2,35
130 x 180	BK040130180	34	38	50	21095	325	217	156	20	M12x35	123,3	3,51
140 x 190	BK040140190	34	38	50	24993	357	221	163	22	M12x35	123,3	3,85
150 x 200	BK040150200	34	38	50	29217	390	225	169	24	M12x35	123,3	4,07
160 x 210	BK040160210	34	38	50	33756	422	229	174	26	M12x35	123,3	4,30
170 x 225	BK040170225	38	44	58	39483	465	212	160	22	M14x40	187	5,80
180 x 235	BK040180235	38	44	58	45606	507	218	167	24	M14x40	187	6,00
190 x 250	BK040190250	46	52	66	56163	591	199	152	28	M14x45	187	8,50
200 x 260	BK040200260	46	52	66	63342	633	203	156	30	M14x45	187	8,60
220 x 285	BK040220285	50	56	72	81960	745	200	154	26	M16x50	290	11,00
240 x 305	BK040240305	50	56	72	103162	860	211	166	30	M16x50	290	12,00
260 x 325	BK040260325	50	56	72	126669	974	221	177	34	M16x50	290	13,00
280 x 355	BK040280355	60	66	84	157339	1124	197	156	32	M18x60	400	19,00
300 x 375	BK040300375	60	66	84	189653	1264	207	166	36	M18x60	400	20,00
320 x 405	BK040320405	72	78	98	264108	1651	211	167	36	M20x70	580	30,00



CALETTATORI NON AUTOCENTRANTI "BK 45"

LOCKING ASSEMBLIES NOT SELF-CENTERING "BK 45"

Non Autocentrante

Momenti torcenti medio bassi

Tolleranze: albero h8 - mozzo H8

Superfici di contatto con rugosità: R_a max 16 μm

Montaggio e smontaggio rapido

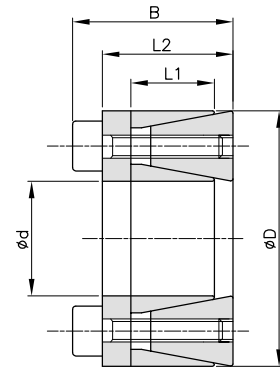
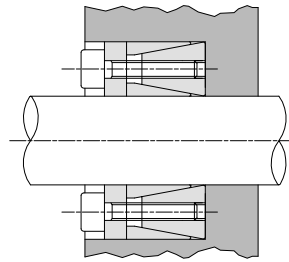

d x D mm	codice	L1 mm	L2 mm	B mm	momento torcente Mt Nm	forza assiale F ass. KN	pressione superficiale		viti di serraggio			Kg.
							albero pw N/mm ²	mozzo pn N/mm ²	DIN 912 12,9 N°	coppia di serraggio Ms Nm	tipo	
18 x 40	BK045018040	12	18,5	24,5	190	21,0	260	120	6	M6x16	17	0,20
19 x 41	BK045019041	12	18,5	24,5	210	22,0	260	120	6	M6x16	17	0,25
20 x 42	BK045020042	12	18,5	24,5	240	24,0	250	120	6	M6x16	17	0,24
24 x 46	BK045024046	12	18,5	24,5	290	24,0	250	120	6	M6x16	17	0,25
25 x 47	BK045025047	12	18,5	24,5	330	26,0	230	120	8	M6x16	17	0,25
28 x 50	BK045028050	12	18,5	24,5	370	26,0	220	120	8	M6x16	17	0,30
30 x 52	BK045030052	12	18,5	24,5	430	28,0	210	120	8	M6x16	17	0,30
35 x 57	BK045035057	15	22	28	610	35,0	170	100	12	M6x16	17	0,32
38 x 60	BK045038060	15	22	28	680	35,0	170	100	12	M6x16	17	0,36
40 x 62	BK045040062	15	22	28	780	39,0	170	100	12	M6x16	17	0,40
42 x 70	BK045042070	18	28	36	1480	70,0	190	110	12	M8x22	41	0,45
45 x 73	BK045045073	18	28	36	1500	66,0	210	130	12	M8x22	41	0,57
48 x 76	BK045048076	18	28	36	1550	66,0	210	130	12	M8x22	41	0,59
50 x 78	BK045050078	18	28	36	1650	66,0	190	120	12	M8x22	41	0,61
55 x 83	BK045055083	18	28	36	2000	72,0	190	120	16	M8x22	41	0,63
60 x 88	BK045060088	18	28	36	2350	78,0	190	120	16	M8x22	41	0,69
70 x 105	BK045070105	22	35	45	3900	111,0	180	120	12	M10x25	83	1,25
80 x 115	BK045080115	22	35	45	4800	120,0	180	120	16	M10x25	83	1,40



CALETTATORI NON AUTOCENTRANTI "BK 50"

LOCKING ASSEMBLIES NOT SELF-CENTERING "BK 50"

Non Autocentrante

Momenti torcenti medio bassi

Tolleranze:

sino al diametro 40 = albero h6 - mozzo H7

oltre al diametro 40 = albero h8 - mozzo H8

Superfici di contatto con rugosità: R_a max 16 μm

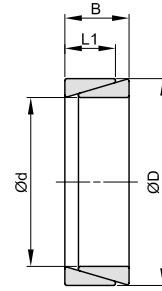
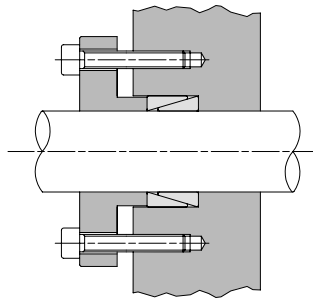

d x D mm	codice	L1 mm	B mm	momento torcente Mt Nm	forza assiale F ass. KN	pressione superficiale		Kg.
						albero pw N/mm ²	mozzo pn N/mm ²	
6 x 9	BK050006009	3,7	4,5	2,4	1	100	75	0,01
7 x 10	BK050007010	3,7	4,5	3,0	1	100	70	0,01
8 x 11	BK050008011	3,7	4,5	4,2	1,1	100	70	0,01
9 x 12	BK050009012	3,7	4,5	5,8	1,3	100	79	0,01
10 x 13	BK050010013	3,7	4,5	7,6	1,7	100	86	0,01
12 x 15	BK050012015	3,7	4,5	10	2	100	80	0,01
13 x 16	BK050013016	3,7	4,5	11,5	3	100	81	0,01
14 x 18	BK050014018	5,3	6,3	19	3	100	77	0,01
15 x 19	BK050015019	5,3	6,3	22	3	100	79	0,01
16 x 20	BK050016020	5,3	6,3	25	3	100	81	0,01
17 x 21	BK050017021	5,3	6,3	28	3	100	80	0,01
18 x 22	BK050018022	5,3	6,3	32	4	100	82	0,01
19 x 24	BK050019024	5,3	6,3	35	4	100	80	0,01
20 x 25	BK050020025	5,3	6,3	39	4	100	79	0,01
22 x 26	BK050022026	5,3	6,3	47	4	100	86	0,01
24 x 28	BK050024028	5,3	6,3	57	5	100	86	0,01
25 x 30	BK050025030	5,3	6,3	61	5	100	84	0,01
28 x 32	BK050028032	5,3	6,3	76	5	100	88	0,01
30 x 35	BK050030035	5,3	6,3	88	6	100	86	0,01
32 x 36	BK050032036	5,3	6,3	100	6	100	88	0,02
35 x 40	BK050035040	6,0	7,0	136	8	100	88	0,02
36 x 42	BK050036042	6,0	7,0	144	8	100	86	0,02
38 x 44	BK050038044	6,0	7,0	160	8	100	87	0,02
40 x 45	BK050040045	6,6	8,0	195	10	100	89	0,03
42 x 48	BK050042048	6,6	8,0	216	10	100	87	0,04
45 x 52	BK050045052	8,6	10,0	321	14	100	87	0,04
48 x 55	BK050048055	8,6	10,0	367	15	100	88	0,05
50 x 57	BK050050057	8,6	10,0	397	16	100	88	0,05
55 x 62	BK050055062	8,6	10,0	480	17	100	88	0,06
56 x 64	BK050056064	10,4	12,0	603	22	100	88	0,07
60 x 68	BK050060068	10,4	12,0	692	23	100	88	0,07
63 x 71	BK050063071	10,4	12,0	764	24	100	89	0,08
65 x 73	BK050065073	10,4	12,0	813	25	100	89	0,08
70 x 79	BK050070079	12,2	14,0	1110	32	100	89	0,11
71 x 80	BK050071080	12,2	14,0	1140	32	100	89	0,12
75 x 84	BK050075084	12,2	14,0	1260	34	100	89	0,12
80 x 91	BK050080091	15,0	17,0	1770	44	100	88	0,20
90 x 101	BK050090101	15,0	17,0	2240	50	100	89	0,22
100 x 114	BK050100114	18,7	21,0	3450	70	100	88	0,38



CALETTATORI AUTOCENTRANTI "BK 61"

LOCKING ASSEMBLIES SELF-CENTERING "BK 61"

Autocentrante

Momenti torcenti medio elevati

Tolleranze: albero h8 - mozzo H8

Superfici di contatto con rugosità: R_a max 16 μ m

Errore di concentricità: 0,02 mm \div 0,04 mm

Tempi di montaggio contenuti

☐ Durante il montaggio si può verificare un leggero spostamento assiale del mozzo rispetto all'albero

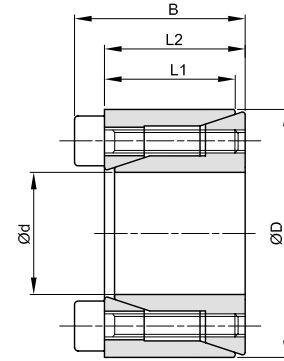
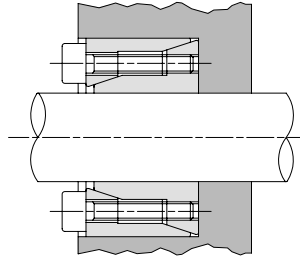

d x D mm	codice	L1 mm	L2 mm	B mm	momento torcente Mt Nm	forza assiale F ass. KN	pressione superficiale		viti di serraggio			Kg.
							albero pw N/mm ²	mozzo pn N/mm ²	DIN 912 12,9 N°	coppia di serraggio Ms Nm	tipo	
5 x 16	BK061005016	10,5	11	13,5	6	2,0	150	55	3	M2,5x10	1,2	0,01
6 x 16	BK061006016	10,5	11	13,5	6	2,0	150	55	3	M2,5x10	1,2	0,01
6,35 x 16	BK061007016	10,5	11	13,5	6	2,0	140	55	3	M2,5x10	1,2	0,01
8 x 18	BK061008018	10,5	11	13,5	10	2,5	110	50	3	M2,5x10	1,2	0,02
9 x 20	BK061009020	12,5	13	15,5	15	3,0	120	55	4	M2,5x12	1,2	0,02
10 x 20	BK061010020	12,5	13	15,5	19	3,8	124	62	4	M2,5x12	1,2	0,02
11 x 22	BK061011022	12,5	13	15,5	21	3,8	113	56	4	M2,5x12	1,2	0,02
12 x 22	BK061012022	12,5	13	15,5	23	3,8	104	56	4	M2,5x12	1,2	0,02
14 x 26	BK061014026	16,5	17	20	39	5,5	106	57	4	M3x16	2,1	0,04
15 x 28	BK061015028	16,5	17	20	42	5,5	99	53	4	M3x16	2,1	0,04
16 x 32	BK061016032	16,5	17	21	77	9,6	161	81	4	M4x16	4,9	0,07
17 x 35	BK061017035	20,5	21	25	82	9,6	119	58	4	M4x20	4,9	0,09
18 x 35	BK061018035	20,5	21	25	87	9,6	113	58	4	M4x20	4,9	0,09
19 x 35	BK061019035	20,5	21	25	91	9,6	107	58	4	M4x20	4,9	0,08
20 x 38	BK061020038	20,5	21	26	157	15,7	166	87	4	M5x20	10	0,10
22 x 40	BK061022040	20,5	21	26	173	15,7	151	83	4	M5x20	10	0,11
24 x 47	BK061024047	25	26	32	268	22,3	171	87	4	M6x24	17	0,20
25 x 47	BK061025047	25	26	32	279	22,3	164	87	4	M6x24	17	0,19
28 x 50	BK061028050	25	26	32	468	33,5	220	123	6	M6x24	17	0,22
30 x 55	BK061030055	25	26	32	502	33,5	206	112	6	M6x24	17	0,27
32 x 55	BK061032055	25	26	32	535	33,5	193	112	6	M6x24	17	0,25
35 x 60	BK061035060	30	31	37	781	44,6	188	110	8	M6x28	17	0,36
38 x 65	BK061038065	30	31	37	848	44,6	173	101	8	M6x28	17	0,43
40 x 65	BK061040065	30	31	37	892	44,6	164	101	8	M6x28	17	0,40
42 x 75	BK061042075	35	36	44	1272	60,6	177	99	6	M8x34	41	0,67
45 x 75	BK061045075	35	36	44	1363	60,6	165	99	6	M8x34	41	0,63
48 x 80	BK061048080	35	36	44	1938	80,8	207	124	8	M8x34	41	0,74
50 x 80	BK061050080	35	36	44	2019	80,8	198	124	8	M8x34	41	0,70



CALETTATORI AUTOCENTRANTI "BK 70" LOCKING ASSEMBLIES SELF-CENTERING "BK 70"

Autocentrante

Momenti torcenti elevati

Tolleranze: albero h8 - mozzo H8

Superfici di contatto con rugosità: R_a max 16 μ m

Errore di concentricità: 0,02 mm \div 0,04mm

Tempi di montaggio contenuti

☐ Durante il montaggio si può verificare un leggero spostamento assiale del mozzo rispetto all'albero

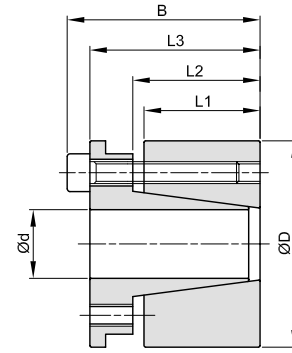
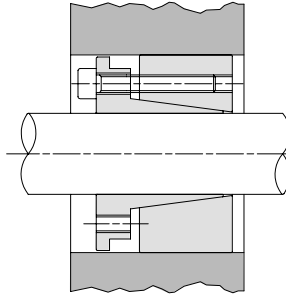

d x D mm	codice	L1 mm	L2 mm	L3 mm	B mm	momento torcente Mt Nm	forza assiale F ass. KN	pressione superficiale		viti di serraggio			Kg.
								albero pw N/mm ²	mozzo pn N/mm ²	DIN 912 12,9 N°	coppia di serraggio Ms Nm	tipo	
19 x 47	BK070019047	26	31	39	45	307	32	193	78	4	M6x25	17	0,39
20 x 47	BK070020047	26	31	39	45	323	32	183	78	4	M6x25	17	0,38
22 x 47	BK070022047	26	31	39	45	355	32	166	78	4	M6x25	17	0,37
24 x 50	BK070024050	26	31	39	45	582	48	229	110	6	M6x25	17	0,43
25 x 50	BK070025050	26	31	39	45	606	48	220	110	6	M6x25	17	0,42
28 x 55	BK070028055	26	31	39	45	679	48	196	100	6	M6x25	17	0,55
30 x 55	BK070030055	26	31	39	45	727	48	183	100	6	M6x25	17	0,56
32 x 60	BK070032060	26	31	39	45	1033	65	229	122	8	M6x25	17	0,60
35 x 60	BK070035060	26	31	39	45	1130	65	209	122	8	M6x25	17	0,50
38 x 65	BK070038065	26	31	39	45	1227	65	193	113	8	M6x25	17	0,60
40 x 65	BK070040065	26	31	39	45	1292	65	183	113	8	M6x25	17	0,60
42 x 75	BK070042075	30	36	47	55	1835	87	204	115	6	M8x30	41	1,00
45 x 75	BK070045075	30	36	47	55	1966	87	191	115	6	M8x30	41	1,00
48 x 80	BK070048080	30	36	47	55	2097	87	179	107	6	M8x30	41	1,10
50 x 80	BK070050080	30	36	47	55	2184	87	172	107	6	M8x30	41	1,00
55 x 85	BK070055085	30	36	47	55	3202	116	208	135	8	M8x30	41	1,10
60 x 90	BK070060090	30	36	47	55	3493	116	191	127	8	M8x30	41	1,20
65 x 95	BK070065095	30	36	47	55	3784	116	176	120	8	M8x30	41	1,30
70 x 110	BK070070110	40	46	57	67	6607	189	199	127	8	M10x35	83	2,20
75 x 115	BK070075115	40	46	62	72	7079	189	186	121	8	M10x35	83	2,50
80 x 120	BK070080120	40	46	62	72	7551	189	174	116	8	M10x35	83	2,60
85 x 125	BK070085125	40	46	62	72	10029	236	205	139	10	M10x35	83	2,80
90 x 130	BK070090130	40	46	62	72	10619	236	193	134	10	M10x35	83	2,70
95 x 135	BK070095135	40	46	62	72	11209	236	183	129	10	M10x35	83	2,90
100 x 145	BK070100145	46	52	77	89	13738	275	176	121	8	M12x45	145	3,90
110 x 155	BK070110155	46	52	77	89	15111	275	160	114	8	M12x45	145	4,20
120 x 165	BK070120165	46	52	77	89	20606	343	183	133	10	M12x45	145	4,80
130 x 180	BK070130180	46	52	77	89	26788	412	203	147	12	M12x45	145	5,00
140 x 190	BK070140190	51	59	84	98	26142	373	154	114	8	M14x45	230	6,50
150 x 200	BK070150200	51	59	84	98	35016	467	180	135	10	M14x45	230	7,00
160 x 210	BK070160210	51	59	84	98	37351	467	169	129	10	M14x45	230	7,00
170 x 225	BK070170225	51	59	84	98	47617	560	191	144	12	M14x45	230	8,77
180 x 235	BK070180235	51	59	84	98	50418	560	180	138	12	M14x45	230	9,00



CALETTATORI AUTOCENTRANTI "BK 71"

LOCKING ASSEMBLIES SELF-CENTERING "BK 71"

Autocentrante

Momenti torcenti elevati

Tolleranze: albero h8 - mozzo H8

Superfici di contatto con rugosità: R_a max 16 μ m

Errore di concentricità: 0,02 mm \div 0,04 mm

Tempi di montaggio contenuti

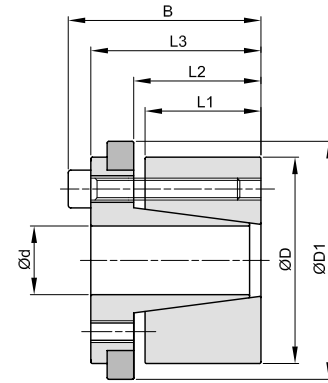
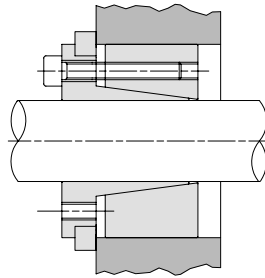

d x D mm	codice	L1 mm	L2 mm	L3 mm	B mm	D1 mm	momento torcente Mt Nm	forza assiale F ass. KN	pressione superficiale		viti di serraggio			Kg.
									albero pw N/mm ²	mozzo pn N/mm ²	DIN 912 12,9 N°	coppia di serraggio Ms Nm	tipo	
19 x 47	BK071019047	26	31	39	45	53	202	21	127	51	4	M6x20	17	0,45
20 x 47	BK071020047	26	31	39	45	53	213	21	121	51	4	M6x20	17	0,46
22 x 47	BK071022047	26	31	39	45	53	234	21	110	51	4	M6x20	17	0,50
24 x 50	BK071024050	26	31	39	45	56	384	32	151	73	6	M6x20	17	0,50
25 x 50	BK071025050	26	31	39	45	56	400	32	145	73	6	M6x20	17	0,50
28 x 55	BK071028055	26	31	39	45	61	448	32	129	66	6	M6x20	17	0,60
30 x 55	BK071030055	26	31	39	45	61	480	32	121	66	6	M6x20	17	0,60
32 x 60	BK071032060	26	31	39	45	66	683	43	151	81	8	M6x20	17	0,70
35 x 60	BK071035060	26	31	39	45	66	747	43	138	81	8	M6x20	17	0,60
38 x 65	BK071038065	26	31	39	45	71	811	43	127	74	8	M6x20	17	0,80
40 x 65	BK071040065	26	31	39	45	71	853	43	121	74	8	M6x20	17	0,60
42 x 75	BK071042075	30	36	47	55	81	1216	58	135	76	6	M8x30	41	1,20
45 x 75	BK071045075	30	36	47	55	81	1302	58	126	76	6	M8x30	41	1,10
48 x 80	BK071048080	30	36	47	55	86	1389	58	119	71	6	M8x30	41	1,30
50 x 80	BK071050080	30	36	47	55	86	1447	58	114	71	6	M8x30	41	1,10
55 x 85	BK071055085	30	36	47	55	91	2124	77	138	89	8	M8x30	41	1,20
60 x 90	BK071060090	30	36	47	55	96	2317	77	127	84	8	M8x30	41	1,15
65 x 95	BK071065095	30	36	47	55	101	2510	77	117	80	8	M8x30	41	1,40
70 x 110	BK071070110	40	46	57	67	116	4381	125	132	84	8	M10x35	83	2,50
75 x 115	BK071075115	40	46	62	72	121	4694	125	123	80	8	M10x35	83	2,60
80 x 120	BK071080120	40	46	62	72	126	5007	125	115	77	8	M10x35	83	2,80
85 x 125	BK071085125	40	46	62	72	131	6651	156	136	92	10	M10x35	83	2,80
90 x 130	BK071090130	40	46	62	72	136	7042	156	128	89	10	M10x35	83	3,00
95 x 135	BK071095135	40	46	62	72	141	7433	156	121	85	10	M10x35	83	3,00
100 x 145	BK071100145	46	52	77	89	151	9104	182	117	81	8	M12x45	145	5,50
110 x 155	BK071110155	46	52	77	89	161	10015	182	106	75	8	M12x45	145	4,80
120 x 165	BK071120165	46	52	77	89	171	13653	228	122	88	10	M12x45	145	5,50
130 x 180	BK071130180	46	52	77	89	186	17747	273	135	97	12	M12x45	145	6,00
140 x 190	BK071140190	51	59	84	98	196	17328	248	102	75	8	M14x45	230	7,50
150 x 200	BK071150200	51	59	84	98	206	23207	309	119	89	10	M14x45	230	7,70
160 x 210	BK071160210	51	59	84	98	216	24754	309	112	85	10	M14x45	230	8,00
170 x 225	BK071170225	51	59	84	98	231	31561	371	126	95	12	M14x45	230	9,80
180 x 235	BK071180235	51	59	84	98	241	33417	371	119	91	12	M14x45	230	9,80



CALETTATORI AUTOCENTRANTI "BK 80" LOCKING ASSEMBLIES SELF-CENTERING "BK 80"

Autocentrante

Momenti torcenti medio elevati
Tolleranze: albero h8 - mozzo H8
Superfici di contatto con rugosità: R_a max 16 μ m
Errore di concentricità: 0,02 \pm 0,04 mm
Tempi di montaggio contenuti
Ingombri radiali ristretti
Pressioni superficiali contenute

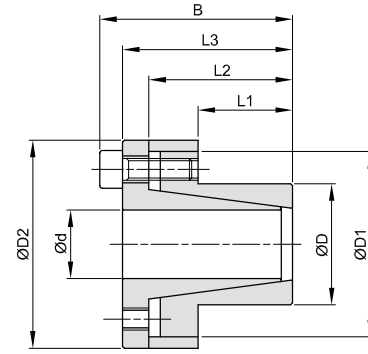
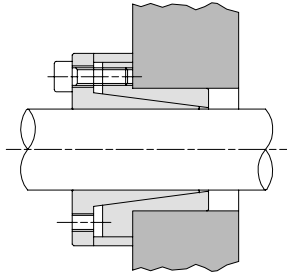

d x D mm	codice	L1 mm	L2 mm	L3 mm	B mm	D1 mm	D2 mm	momento torcente Mt Nm	forza assiale F ass. KN	pressione superficiale		viti di serraggio			Kg.
										albero pw N/mm ²	mozzo pn N/mm ²	DIN 912 12,9 N°	coppia di serraggio Ms Nm	tipo	
6 x 14	BK080006014	10	18,5	22,5	25,5	22	25	12	5	190	80	3	M3x10	2,2	0,05
8 x 15	BK080008015	12	21	24	28	25	28	39	10	299	159	4	M4x10	5,2	0,08
9 x 16	BK080009016	14	23	27	31	28	32	44	10	227	128	4	M4x12	5,2	0,08
10 x 16	BK080010016	14	23	27	31	28	32	49	10	205	128	4	M4x12	5,2	0,08
11 x 18	BK080011018	14	23	27	31	30	34	53	10	186	114	4	M4x12	5,2	0,09
12 x 18	BK080012018	14	23	27	31	30	34	58	10	171	114	4	M4x12	5,2	0,09
14 x 23	BK080014023	14	23	27	31	35	39	68	10	146	89	4	M4x12	5,2	0,20
15 x 24	BK080015024	16	29	36	42	40	45	120	16	196	123	4	M6x18	17	0,21
16 x 24	BK080016024	16	29	36	42	40	45	128	16	184	123	4	M6x18	17	0,23
17 x 26	BK080017026	18	31	38	44	42	47	180	21	200	140	4	M6x18	17	0,25
18 x 26	BK080018026	18	31	38	44	42	47	191	21	194	134	4	M6x18	17	0,27
19 x 27	BK080019027	18	31	38	44	43	48	202	21	183	129	4	M6x18	17	0,29
20 x 28	BK080020028	18	31	38	44	44	49	213	21	174	124	4	M6x18	17	0,30
22 x 32	BK080022032	25	38	45	51	48	54	234	21	114	78	4	M6x18	17	0,38
24 x 34	BK080024034	25	38	45	51	50	56	255	21	105	74	4	M6x18	17	0,41
25 x 34	BK080025034	25	38	45	51	50	56	266	21	100	74	4	M6x18	17	0,35
28 x 39	BK080028039	25	38	45	51	55	61	373	27	112	81	5	M6x18	17	0,47
30 x 41	BK080030041	25	38	45	51	57	63	480	32	126	92	6	M6x18	17	0,48
32 x 43	BK080032043	30	43	50	56	59	65	511	32	98	73	6	M6x18	17	0,51
35 x 47	BK080035047	30	43	50	56	63	69	747	43	120	89	8	M6x18	17	0,60
38 x 50	BK080038050	30	43	50	56	66	72	811	43	110	84	8	M6x18	17	0,67
40 x 53	BK080040053	32	45	52	58	69	75	959	48	110	83	9	M6x18	17	0,73
42 x 55	BK080042055	32	45	52	58	71	77	1007	48	105	80	9	M6x18	17	0,78
45 x 59	BK080045059	40	56	64	72	79	85	1781	79	130	99	8	M8x22	42	1,23
48 x 62	BK080048062	40	56	64	72	82	88	1900	79	122	94	8	M8x22	42	1,24
50 x 65	BK080050065	50	66	74	82	85	92	2473	99	117	90	10	M8x22	42	1,40
55 x 71	BK080055071	50	66	74	82	91	98	2721	99	106	82	10	M8x22	42	1,70
60 x 77	BK080060077	50	66	74	82	97	104	2968	99	97	76	10	M8x22	42	1,76
65 x 84	BK080065084	50	66	74	82	104	111	3215	99	90	69	10	M8x22	42	2,21
70 x 90	BK080070090	60	80	91	101	115	122	4430	127	89	69	8	M10x25	84	3,05
75 x 95	BK080075095	60	80	91	101	119	126	5338	142	93	74	9	M10x25	84	3,32
80 x 100	BK080080100	65	85	96	106	124	131	7595	190	108	86	12	M10x25	84	3,50
85 x 106	BK080085106	65	85	96	106	130	137	8069	190	101	81	12	M10x25	84	3,60
90 x 112	BK080090112	65	85	96	106	136	143	9968	222	112	90	14	M10x25	84	3,90
95 x 120	BK080095120	65	85	96	106	144	153	10522	222	106	84	14	M10x25	84	4,40
100 x 125	BK080100125	65	89	102	114	153	162	13651	273	124	99	12	M12x30	145	4,60
110 x 140	BK080110140	70	94	107	119	168	177	15016	273	105	82	12	M12x30	145	7,13
120 x 155	BK080120155	90	114	127	139	185	195	21844	364	99	77	16	M12x30	145	10,70
130 x 165	BK080130165	90	114	127	139	195	205	23664	364	92	72	16	M12x30	145	11,30
140 x 175	BK080140175	90	114	127	139	205	215	25485	364	85	68	16	M12x30	145	11,90
150 x 185	BK080150185	90	114	127	139	215	225	27305	364	80	64	16	M12x30	145	12,50



CALETTATORI - GIUNTO RIGIDO "BK 95" LOCKING ASSEMBLIES - RIGID COUPLING "BK 95"

Momenti torcenti medio elevati
Tolleranze: albero h8
Superficie di contatto con rugosità: R_a max 16 μm
Montaggio e smontaggio rapido
Adatto per il collegamento rigido
fra due alberi allineati

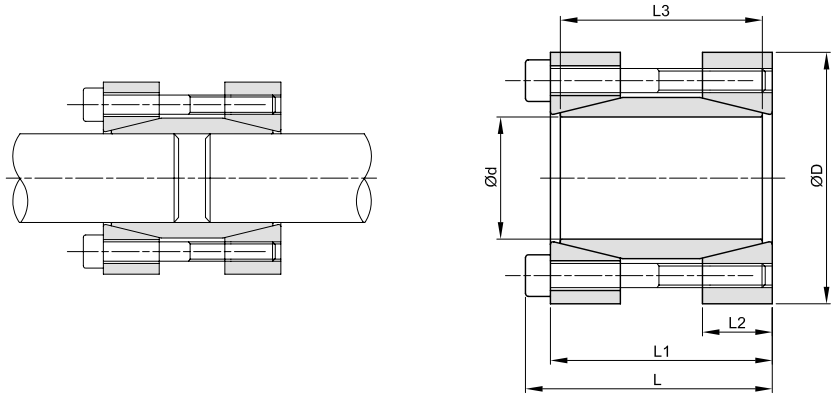

d x D mm	codice	L mm	L1 mm	L2 mm	L3 mm	momento torcente Mt Nm	forza assiale F ass. KN	pressione superficiale	viti di serraggio			Kg.
								albero pw N/mm ²	DIN 912 12,9 N°	coppia di serraggio Ms Nm	tipo	
17 x 50	BK095017050	56	50	16	44	179	21	166	4	M6x45	17	0,51
18 x 50	BK095018050	56	50	16	44	190	21	157	4	M6x45	17	0,52
19 x 50	BK095019050	56	50	16	44	200	21	149	4	M6x45	17	0,50
20 x 50	BK095020050	56	50	16	44	211	21	141	4	M6x45	17	0,50
24 x 55	BK095024055	66	60	18,5	54	378	32	144	6	M6x55	17	0,71
25 x 55	BK095025055	66	60	18,5	54	394	32	138	6	M6x55	17	0,69
28 x 60	BK095028060	66	60	18,5	54	442	32	123	6	M6x55	17	0,81
30 x 60	BK095030060	66	60	18,5	54	473	32	115	6	M6x55	17	0,78
32 x 63	BK095032063	66	60	18,5	54	505	32	108	6	M6x55	17	0,85
35 x 75	BK095035075	83	75	22	67	682	39	98	4	M8x70	42	1,48
38 x 75	BK095038075	83	75	22	67	741	39	90	4	M8x70	42	1,45
40 x 75	BK095040075	83	75	22	67	780	39	86	4	M8x70	42	1,40
42 x 78	BK095042078	83	75	22	67	819	39	82	4	M8x70	42	1,50
45 x 85	BK095045085	93	85	24,5	76	1317	59	101	6	M8x80	42	2,03
48 x 90	BK095048090	93	85	24,5	76	1405	59	95	6	M8x80	42	2,24
50 x 90	BK095050090	93	85	24,5	76	1463	59	91	6	M8x80	42	2,18
55 x 94	BK095055094	93	85	24,5	76	2147	78	110	8	M8x80	42	2,29
60 x 100	BK095060100	93	85	24,5	76	2343	78	101	8	M8x80	42	2,52
65 x 105	BK095065105	93	85	24,5	76	2538	78	93	8	M8x80	42	2,69
70 x 115	BK095070115	110	100	29	90	4321	123	116	8	M10x95	83	3,94



CALETTATORI AUTOCENTRANTI "BK 10" LOCKING ASSEMBLIES SELF-CENTERING "BK 10"

Autocentrante

Momenti torcenti bassi

Tolleranze: albero h7 - mozzo H7

Superfici di contatto con rugosità: R_a max 16 μ m

Montaggio e smontaggio rapido

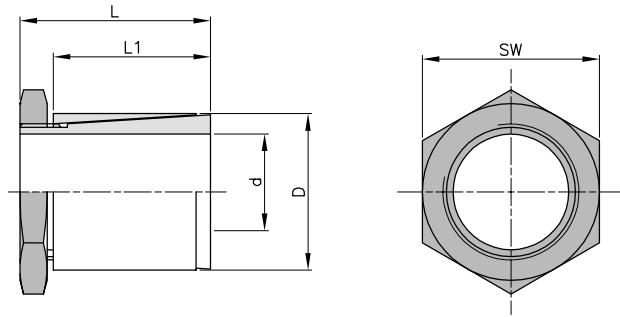

Materiale: INOX

d x D mm	codice	L mm	L1 mm	SW mm	momento torcente max Mt Nm	serraggio		Kg.
						ghiera tipo	coppia di serraggio Ms Nm	
4 x 8	BKSS010004008	15	12,5	8	3	M6x0,5	4	0,01
5 x 10	BKSS010005010	15	12,5	10	4	M8x0,5	5	0,01
6 x 10	BKSS010006010	15	12,5	10	7	M8x0,5	8	0,01
6,35 x 10	BKSS010635010	15	12,5	10	7	M8x0,5	8	0,01
7 x 12	BKSS010007012	15	12,0	12	8	M10x0,75	9	0,01
8 x 14	BKSS010008014	22	19,0	16	14	M12x1	15	0,02
9 x 14	BKSS010009014	22	19,0	16	14	M12x1	15	0,02
9,53 x 14	BKSS010953014	22	19,0	16	14	M12x1	15	0,02
10 x 17	BKSS010010017	22	18,5	18	18	M15x1	19	0,03
11 x 17	BKSS010011017	22	18,5	18	18	M15x1	19	0,03
12 x 17	BKSS010012017	22	18,5	18	18	M15x1	19	0,03
14 x 20	BKSS010014020	28	23,0	20	24	M17x1	25	0,04
15 x 20	BKSS010015020	28	23,0	20	24	M17x1	25	0,04
15,88 x 23	BKSS010158023	28	23,0	26	26	M20x1	27	0,05
16 x 23	BKSS010016023	28	23,0	26	26	M20x1	27	0,05
17 x 23	BKSS010017025	28	23,0	26	26	M20x1	27	0,05
19 x 25	BKSS010019025	28	23,0	27	29	M22x1	30	0,05
20 x 28	BKSS010020028	28	23,0	30	31	M25x1	32	0,07



CALETTATORI AUTOCENTRANTI "BK 30"

LOCKING ASSEMBLIES SELF-CENTERING "BK 30"

Autocentrante

Momenti torcenti medio bassi
 Tolleranze: albero h7 - mozzo H8
 Superfici di montaggio con rugosità: $R_t = 16 \mu\text{m}$
 Errore di concentricità: $0,02 \div 0,04 \text{ mm}$
 Montaggio e smontaggio rapido

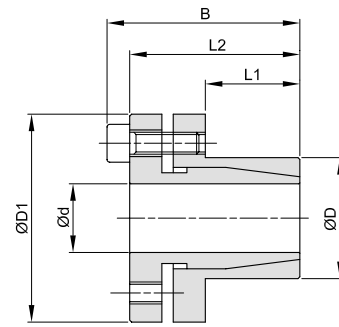
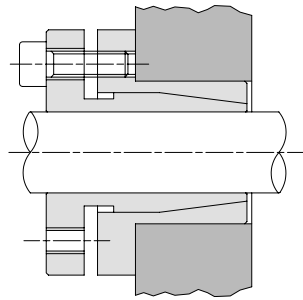

Materiale: INOX

d x D mm	codice	L1 mm	L2 mm	B mm	ØD1 mm	momento torcente Mt Nm	forza assiale F ass. KN	viti di serraggio		coppia di serraggio Ms Nm	Kg.
								DIN 912 S.S. N°	tipo		
6 x 14	BKSS030006014	10	19,0	22,0	25	5	1,7	3	M3	1,2	0,03
8 x 15	BKSS030008015	12	21,5	25,5	27	17	4,4	3	M4	2,7	0,04
10 x 16	BKSS030010016	14	24,0	28,0	28	23	4,4	3	M4	2,7	0,05
12 x 18	BKSS030012018	14	25,5	29,5	30	27	4,4	3	M4	2,7	0,06
14 x 22	BKSS030014022	15	27,5	31,5	35	48	6,5	4	M4	2,7	0,08



CALETTATORI NON AUTOCENTRANTI "BK 40"

LOCKING ASSEMBLIES NOT SELF-CENTERING "BK 40"

Non Autocentrante

Momenti torcenti medio elevati

Tolleranze: albero h11 - mozzo H11

Superfici di contatto con rugosità: R_a max $16 \mu\text{m}$

Smontaggio rapido

- Per ottenere una buona concentricità è necessaria una guida tra albero e mozzo

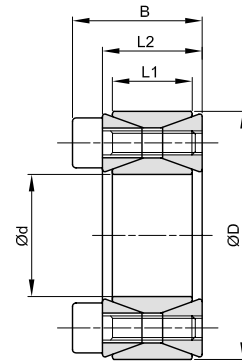
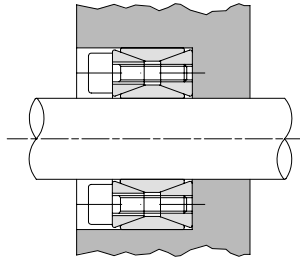

Materiale: INOX

d x D mm	codice	L1 mm	L2 mm	B mm	momento torcente Mt Nm	forza assiale F ass. KN	pressione superficiale		viti di serraggio			Kg.
							albero pw N/mm ²	mozzo pn N/mm ²	DIN 912 S.S. N°	coppia di serraggio Ms Nm	tipo	
20 x 47	BKSS040020047	17	20	26	110	11,0	133	57	8	M6x18	8	0,23
22 x 47	BKSS040022047	17	20	26	120	11,0	121	57	8	M6x18	8	0,23
24 x 50	BKSS040024050	17	20	26	150	12,0	125	60	9	M6x18	8	0,26
25 x 50	BKSS040025050	17	20	26	155	12,0	120	60	9	M6x18	8	0,25
28 x 55	BKSS040028055	17	20	26	170	12,0	107	55	9	M6x18	8	0,30
30 x 55	BKSS040030055	17	20	26	185	12,0	100	55	9	M6x18	8	0,29
32 x 60	BKSS040032060	17	20	26	265	16,0	125	66	12	M6x18	8	0,34
35 x 60	BKSS040035060	17	20	26	290	16,0	114	67	12	M6x18	8	0,32
38 x 65	BKSS040038065	17	20	26	390	20,0	131	77	15	M6x18	8	0,36
40 x 65	BKSS040040065	17	20	26	410	20,0	125	77	15	M6x18	8	0,34
42 x 75	BKSS040042075	20	24	32	595	20,0	138	78	12	M8x22	18	0,60
45 x 75	BKSS040045075	20	24	32	635	28,0	129	78	12	M8x22	18	0,57
48 x 80	BKSS040048080	20	24	32	680	28,0	121	73	12	M8x22	18	0,60
50 x 80	BKSS040050080	20	24	32	700	28,0	116	73	12	M8x22	18	0,60



CALETTATORI AUTOCENTRANTI "BK 61"

LOCKING ASSEMBLIES SELF-CENTERING "BK 61"

Autocentrante

Momenti torcenti medio elevati

Tolleranze: albero h8 - mozzo H8

Superfici di contatto con rugosità: R_a max 16 μm

Errore di concentricità: 0,02 mm \div 0,04 mm

Tempi di montaggio contenuti

☐ Durante il montaggio si può verificare un leggero spostamento assiale del mozzo rispetto all'albero

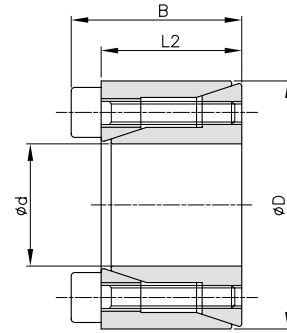
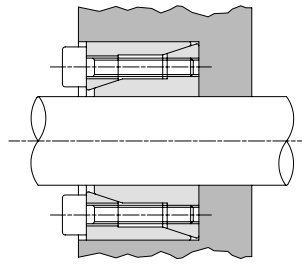

Materiale: INOX

d x D mm	codice	L2 mm	B mm	momento torcente Mt Nm	forza assiale F ass. KN	pressione superficiale		viti di serraggio			Kg.
						albero pw N/mm ²	mozzo pn N/mm ²	DIN 912 S.S. N°	coppia di serraggio Ms Nm	tipo	
6 x 16	BKSS061006016	11	13,5	3	0,9	49	19	3	M2,5x10	0,5	0,01
7 x 17	BKSS061007017	11	13,5	3	0,9	42	17	3	M2,5x10	0,5	0,01
8 x 18	BKSS061008018	11	13,5	4	0,9	37	17	3	M2,5x10	0,5	0,02
9 x 20	BKSS061009020	13	15,5	6	1,2	37	17	4	M2,5x12	0,5	0,02
10 x 20	BKSS061010020	13	15,5	6	1,2	33	17	4	M2,5x12	0,5	0,02
11 x 22	BKSS061011022	13	15,5	7	1,2	30	15	4	M2,5x12	0,5	0,02
12 x 22	BKSS061012022	13	15,5	7	1,2	26	15	4	M2,5x12	0,5	0,02
14 x 26	BKSS061014026	17	20,0	13	1,9	28	15	4	M3x16	0,9	0,04
15 x 28	BKSS061015028	17	20,0	14	1,9	26	14	4	M3x16	0,9	0,04
16 x 32	BKSS061016032	17	21,0	28	3,5	45	23	4	M4x16	2,2	0,07
17 x 35	BKSS061017035	21	25,0	30	3,5	34	17	4	M4x20	2,2	0,09
18 x 35	BKSS061018035	21	25,0	32	3,5	32	17	4	M4x20	2,2	0,09
19 x 35	BKSS061019035	21	25,0	34	3,5	31	17	4	M4x20	2,2	0,08
20 x 38	BKSS061020038	21	26,0	55	5,5	45	24	4	M5x20	4,2	0,10
22 x 40	BKSS061022040	21	26,0	61	5,5	41	23	4	M5x20	4,2	0,11
24 x 47	BKSS061024047	26	32,0	96	8,0	44	23	4	M6x24	7,3	0,20
25 x 47	BKSS061025047	26	32,0	100	8,0	43	23	4	M6x24	7,3	0,19
28 x 50	BKSS061028050	26	32,0	210	15,0	57	32	6	M6x24	7,3	0,22
30 x 55	BKSS061030055	26	32,0	220	15,0	54	29	6	M6x24	7,3	0,27
32 x 55	BKSS061032055	26	32,0	240	15,0	50	29	6	M6x24	7,3	0,25
35 x 60	BKSS061035060	29	35,0	350	20,0	55	32	6	M6x28	7,3	0,36
38 x 65	BKSS061038065	29	35,0	380	20,0	51	29	6	M6x28	7,3	0,43
40 x 65	BKSS061040065	29	35,0	400	20,0	48	29	6	M6x28	7,3	0,40



CALETTATORI AUTOCENTRANTI "BK 80" LOCKING ASSEMBLIES SELF-CENTERING "BK 80"

Autocentrante

Momenti torcenti medio elevati
Tolleranze: albero h8 - mozzo H8
Superfici di contatto con rugosità: R_a max 16 μ m
Errore di concentricità: $0,02 \div 0,04$ mm
Tempi di montaggio contenuti
Ingombri radiali ristretti
Pressioni superficiali contenute

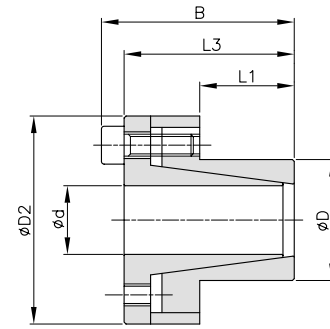
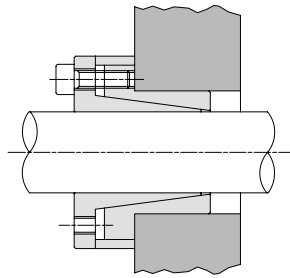

Materiale: INOX

d x D mm	codice	L1 mm	L3 mm	B mm	D2 mm	momento torcente Mt Nm	forza assiale F ass. KN	pressione superficiale		viti di serraggio			Kg.
								albero pw N/mm ²	mozzo pn N/mm ²	DIN 912 S.S. N°	coppia di serraggio Ms Nm	tipo	
10 x 16	BKSS080010016	14	27	31	29	22	4,0	82	51	4	M4x12	2	0,15
12 x 18	BKSS080012018	14	28	32	32	26	4,0	69	46	4	M4x12	2	0,18
14 x 23	BKSS080014023	14	28	32	38	30	4,0	59	36	4	M4x12	2	0,20
15 x 24	BKSS080015024	16	37	43	44	73	10,0	107	67	4	M6x18	8	0,31
16 x 24	BKSS080016024	16	37	43	44	78	10,0	101	67	3	M6x18	8	0,30
18 x 26	BKSS080018026	18	39	45	47	87	10,0	79	55	4	M6x18	8	0,32
19 x 27	BKSS080019027	18	39	45	49	92	10,0	75	53	4	M6x18	8	0,35
20 x 28	BKSS080020028	18	39	45	50	97	10,0	71	51	4	M6x18	8	0,36
22 x 32	BKSS080022032	25	46	52	54	105	10,0	47	32	4	M6x18	8	0,45
24 x 34	BKSS080024034	25	46	52	56	175	15,0	64	45	6	M6x18	8	0,48
25 x 34	BKSS080025034	25	46	52	56	180	15,0	62	45	6	M6x18	8	0,50
28 x 39	BKSS080028039	25	46	52	61	200	15,0	55	40	6	M6x18	8	0,52
30 x 41	BKSS080030041	25	46	52	62	220	15,0	51	38	6	M6x18	8	0,52
32 x 43	BKSS080032043	25	46	52	65	310	19,0	64	48	6	M6x18	8	0,58
35 x 47	BKSS080035047	32	53	59	66	340	19,0	46	34	8	M6x18	8	0,69
38 x 50	BKSS080038050	32	53	59	72	370	19,0	42	32	8	M6x18	8	0,73
40 x 53	BKSS080040053	32	53	59	75	390	19,0	40	30	8	M6x18	8	0,80
42 x 55	BKSS080042055	32	53	59	78	410	19,0	39	29	8	M6x18	8	1,05
45 x 59	BKSS080045059	45	70	78	86	820	36,0	48	36	8	M8x22	18	1,40
48 x 62	BKSS080048062	45	70	78	87	880	36,0	45	35	8	M8x22	18	1,50
50 x 65	BKSS080050065	45	70	78	92	910	36,0	43	33	8	M8x22	18	1,60

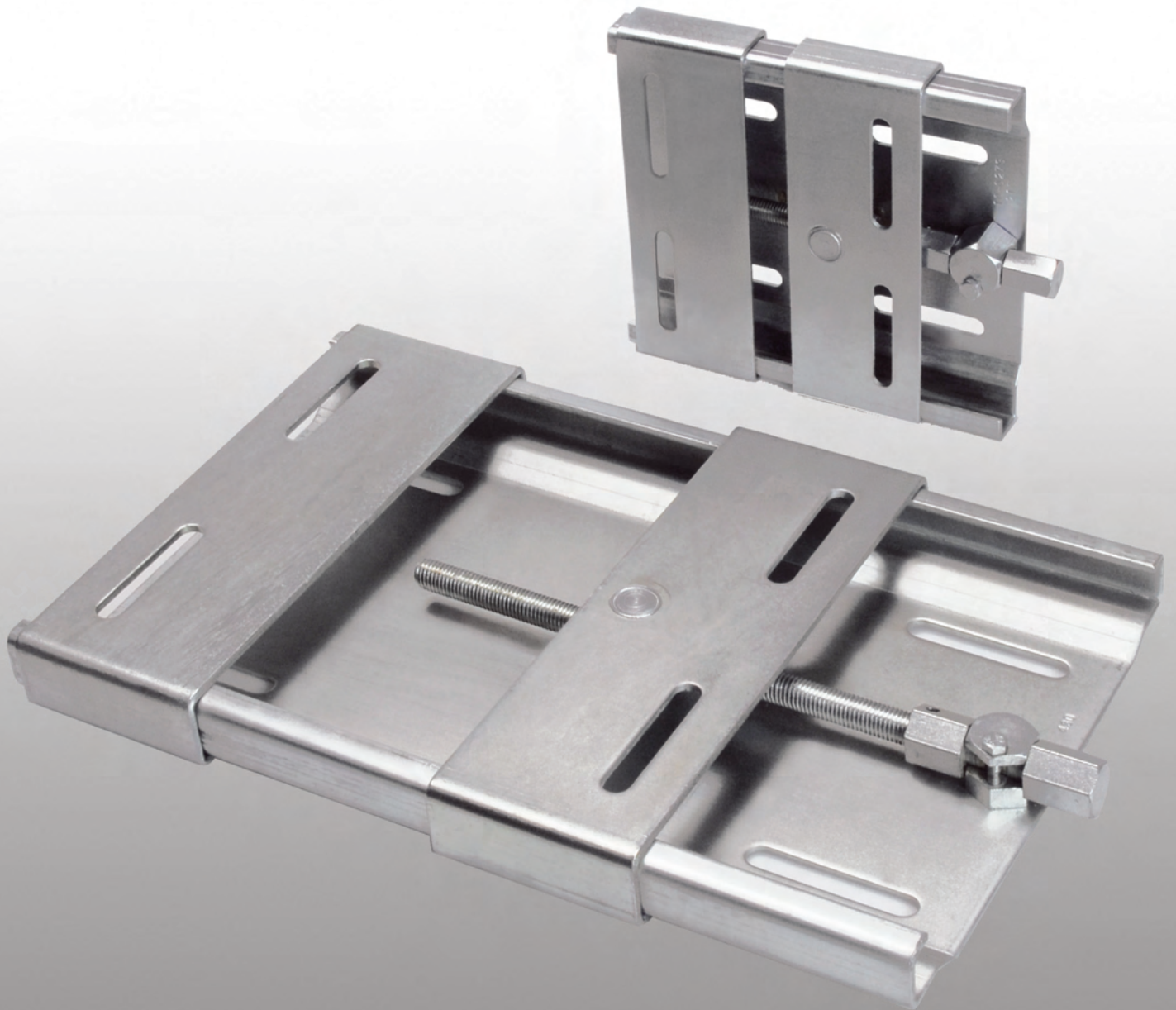



SLITTE TENDICINGHIA PER MOTORI ELETTRICI ADJUSTABLE MOTOR MOUNTING

Descrizione - Description

Le slitte porta motore risolvono il problema della tensione delle cinghie nelle trasmissioni di potenza.

Sono di facile montaggio e permettono la regolazione di tensionamento o lo smontaggio delle cinghie senza dover rimuovere il motore elettrico. Il movimento della slitta è comandato da una vite che si regola con una comune chiave.

The adjustable motor mountings solve the problem of the belt tension in the power transmission.

They are easy to assemble and allow adjustment of belt tension or disassembly without removing the electric motor. The movement of the motor is controlled by a screw which is adjusted by a common key.

Materiale - Material

Le slitte tendicinghia sono in lamiera di acciaio zincato, trattamento che protegge dall'ossidazione e dalla corrosione.

The adjustable motor mountings are in zinc plated steel, treatment that protects against oxidation and corrosion.

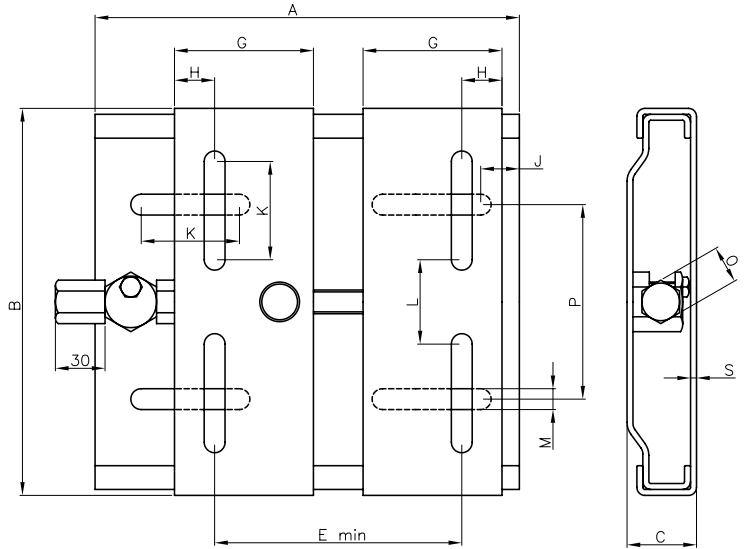

tipo	codice	A	B	C	E min	L	G	H	J	K	M	O	P	S	Kg.
210	SL210	210	195	33	100	43	70	20	25	50	10,5	19	98	3	2,20
270	SL270	270	195	33	100	43	70	20	25	50	10,5	19	98	3	2,70
307	SL307	307	213	33	100	65	70	20	25	50	10,5	19	108	3	3,30
340	SL340	340	290	40	135	90	95	27	30	62,5	12,5	22	165	4	6,30
430	SL430	430	290	40	135	90	95	27	30	62,5	12,5	22	165	4	7,40
490	SL490	490	410	40	110	193	95	40	30	60	15,0	22	284	4	10,80

tipo	Motori	63	71	80	90	100	112	132	160	180
210	CORSA DI REGOLAZIONE mm	70	58	45						
270		130	118	105	90	70	40			
307					127	107	77			
340					140	130	100	75		
430						216	186	160	122	
490									156	131





GIUNTI ELASTICI TORSIONALI - "GEB" TORSIONAL FLEXIBLE COUPLINGS - "GEB"

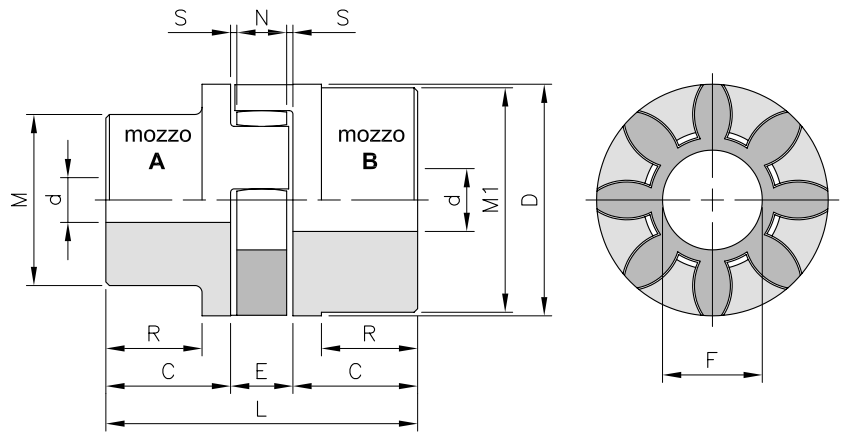

Materiale: Ghisa GG25 / * Materiale acciaio

descrizione	codice		Preforo		Foro max (d)		DIMENSIONI									
	mozzo A	mozzo B	mozzo A	mozzo B	mozzo A	mozzo B	C	D	E ⁽¹⁾	F	M	M1	N	R	S	L
	A	B	mm	mm	mm	mm	mm	mm	mm	mm	mm	mm	mm	mm	mm	mm
GEB 19-24*	GEB1A019	GEB1B019	-	-	19	24	25	40	16	18	30	40	12	19,0	2,0	66
GEB 24-32	GEB1A024	GEB1B024	-	-	24	32	30	55	18	27	40	55	14	24,0	2,0	78
GEB 28-38	GEB1A028	GEB1B028	-	-	28	38	35	65	20	30	48	65	15	27,5	2,5	90
GEB 38-45	GEB1A038	GEB1B038	-	-	38	45	45	80	24	38	66	78	18	36,5	3,0	114
GEB 42-55	GEB1A042	GEB1B042	-	-	42	55	50	95	26	46	75	94	20	40,0	3,0	126
GEB 48-60	GEB1A048	GEB1B048	-	-	48	60	56	105	28	51	85	104	21	45,0	3,5	140
GEB 55-70	GEB1A055	GEB1B055	-	-	55	70	65	120	30	60	98	118	22	52,0	4,0	160
GEB 65-75	GEB1A065	GEB1B065	-	-	65	75	75	135	35	68	115	134	26	61,0	4,5	185
GEB 75-90	GEB1A075	GEB1B075	-	-	75	90	85	160	40	80	135	158	30	69,0	5,0	210
GEB 90-100	GEB1A090	GEB1B090	38	38	90	100	100	200	45	100	160	180	34	81,0	5,5	245

(1) Quote di montaggio



GIUNTI ELASTICI TORSIONALI PER BUSSOLA CONICA - "GEB TL" TORSIONAL FLEXIBLE COUPLINGS FOR TAPER BUSHES - "GEB TL"

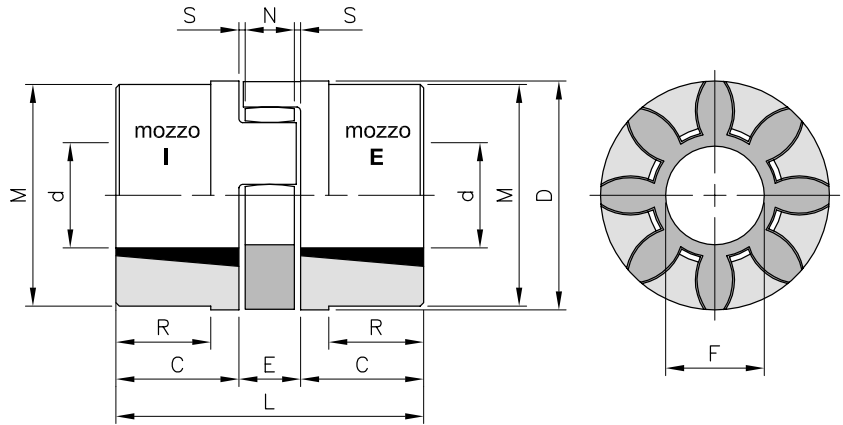

Materiale: Ghisa GG25

descrizione	codice		Bussola	Diametro Foro (d)		DIMENSIONI								
	mozzo E	mozzo I		min. mm	max. mm	C mm	D mm	E ⁽¹⁾ mm	F mm	M mm	N mm	R mm	S mm	L mm
GEB 28-38 TL	GEB2E028	GEB2I028	1108	11	28	23	65	20	30	65	15	-	2,5	66
GEB 38-45 TL	GEB2E038	GEB2I038	1108	11	28	23	80	24	38	78	18	15	3,0	70
GEB 42-55 TL	GEB2E042	GEB2I042	1610	12	42	26	95	26	46	94	20	16	3,0	78
GEB 48-60 TL	GEB2E048	GEB2I048	1615	14	42	39	105	28	51	104	21	28	3,5	106
GEB 55-70 TL	GEB2E055	GEB2I055	2012	15	50	33	120	30	60	118	22	20	4,0	96
GEB 75-90 TL	GEB2E075	GEB2I075	2517	19	65	52	160	40	80	158	30	41	5,0	144

(1) Quote di montaggio



GIUNTI ELASTICI TORSIONALI - "GEB AL" TORSIONAL FLEXIBLE COUPLINGS - "GEB AL"

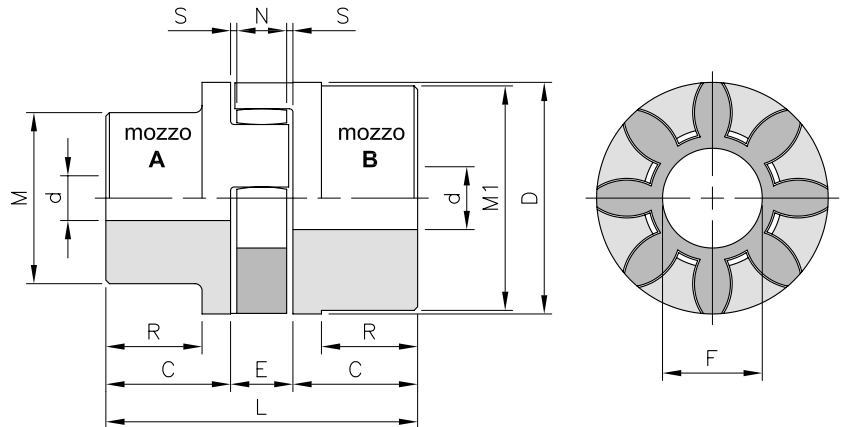
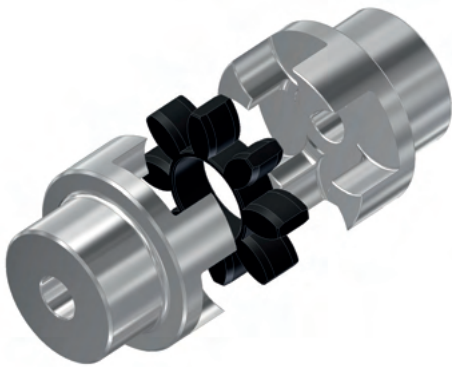

Materiale: Alluminio

descrizione	codice		Preforo		Foro max (d)		DIMENSIONI									
	mozzo A	mozzo B	mozzo A	mozzo B	mozzo A	mozzo B	C mm	D mm	E ⁽¹⁾ mm	F mm	M mm	M1 mm	N mm	R mm	S mm	L mm
GEB 19-24 AL	GEB3A019	GEB3B019	-	10	19	24	25	40	16	18	30	40	12	19,0	2,0	66
GEB 24-32 AL	GEB3A024	GEB3B024	8	14	24	32	30	55	18	27	40	55	14	24,0	2,0	78
GEB 28-38 AL	GEB3A028	GEB3B028	10	16	28	38	35	65	20	30	48	65	15	27,5	2,5	90
GEB 38-45 AL	GEB3A038	GEB3B038	12	20	38	45	45	80	24	38	66	78	18	36,5	3,0	114

(1) Quote di montaggio



GIUNTI ELASTICI TORSIONALI - "GEB" TORSIONAL FLEXIBLE COUPLINGS - "GEB"

Elemento dentato elastico in poliuretano (colore GIALLO) - "92 Shore A"

- Angolo di torsione normale 3,2°
- Angolo di torsione max 5°
- Temperatura di impiego da -40° a +125°

descrizione	codice	Giri / 1' max	Momenti torcenti (Nm)		
			TK normale	TK max	TkW con inversione
GEB 19-24	ELG019	14.000	10	20	2,6
GEB 24-32	ELG024	10.600	35	70	9,1
GEB 28-38	ELG028	8.500	95	190	25,0
GEB 38-45	ELG038	7.100	190	380	49,0
GEB 42-55	ELG042	6.000	265	530	69,0
GEB 48-60	ELG048	5.600	310	620	81,0
GEB 55-70	ELG055	4.750	410	820	107,0
GEB 65-75	ELG065	4.250	625	1.250	163,0
GEB 75-90	ELG075	3.550	1.280	2.560	333,0
GEB 90-100	ELG090	2.800	2.400	4.800	624,0

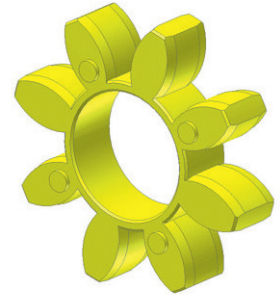

Elemento dentato elastico in poliuretano (colore NERO) - "94 Shore A"

- Angolo di torsione normale 3,2°
- Angolo di torsione max 5°
- Temperatura di impiego da -40° a +125°

descrizione	codice	Giri / 1' max	Momenti torcenti (Nm)		
			TK normale	TK max	TkW con inversione
GEB 19-24	ELN019	14.000	12	24	3,2
GEB 24-32	ELN024	10.600	43	86	11,4
GEB 28-38	ELN028	8.500	126	233	30,6
GEB 38-45	ELN038	7.100	235	470	61,0
GEB 42-55	ELN042	6.000	326	653	85,0
GEB 48-60	ELN048	5.600	381	763	99,7
GEB 55-70	ELN055	4.750	500	1.003	130,7
GEB 65-75	ELN065	4.250	730	1.460	190,0
GEB 75-90	ELN075	3.550	1.493	2.986	388,3
GEB 90-100	ELN090	2.800	2.800	5.600	728,0



Elemento dentato elastico in poliuretano (colore ROSSO) - "98 Shore A"

- Angolo di torsione normale 3,2°
- Angolo di torsione max 5°
- Temperatura di impiego da -40° a +125°

descrizione	codice	Giri / 1' max	Momenti torcenti (Nm)		
			TK normale	TK max	TkW con inversione
GEB 19-24	ELR019	14.000	17	34	4,4
GEB 24-32	ELR024	10.600	60	120	16,0
GEB 28-38	ELR028	8.500	160	320	42,0
GEB 38-45	ELR038	7.100	325	650	85,0
GEB 42-55	ELR042	6.000	450	900	117,0
GEB 48-60	ELR048	5.600	525	1.050	137,0
GEB 55-70	ELR055	4.750	685	1.370	178,0
GEB 65-75	ELR065	4.250	940	1.880	244,0
GEB 75-90	ELR075	3.550	1.920	3.840	499,0
GEB 90-100	ELR090	2.800	3.600	7.200	936,0

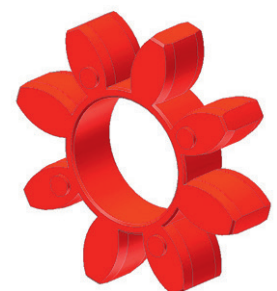



GIUNTI ELASTICI TORSIONALI - "GEB" TORSIONAL FLEXIBLE COUPLINGS - "GEB"



descrizione	MASSA GIUNTI GEB				MASSA GIUNTI GEB-TL				MASSA GIUNTI GEB-AL			
	elemento elastico Kg	mozzo A Kg	mozzo B Kg	J ⁽¹⁾ Kg/cm ²	elemento elastico Kg	mozzo I Kg	mozzo E Kg	J ⁽¹⁾ Kg/cm ²	elemento elastico Kg	mozzo A Kg	mozzo B Kg	J ⁽¹⁾ Kg/cm ²
GEB 19-24	0,004	0,18	0,25	0,8	-	-	-	-	0,004	0,07	0,08	0,4
GEB 24-32	0,014	0,36	0,55	3,0	-	-	-	-	0,014	0,13	0,18	1,0
GEB 28-38	0,025	0,60	0,85	7,0	0,025	0,50	0,50	7,0	0,025	0,22	0,30	3,0
GEB 38-45	0,042	1,35	1,65	20,0	0,042	0,88	0,88	26,0	0,042	0,48	0,55	8,0
GEB 42-55	0,066	2,00	2,30	50,0	0,066	1,40	1,40	36,0	-	-	-	-
GEB 48-60	0,088	2,75	3,10	80,0	0,088	2,33	2,33	78,0	-	-	-	-
GEB 55-70	0,116	4,20	4,50	160,0	0,116	2,10	2,10	120,0	-	-	-	-
GEB 65-75	0,172	6,50	6,80	310,0	-	-	-	-	-	-	-	-
GEB 75-90	0,325	10,00	10,80	680,0	0,325	6,80	6,80	630,0	-	-	-	-
GEB 90-100	0,440	14,00	15,80	1.590,0	-	-	-	-	-	-	-	-

(1) Momento d'inerzia giunto con mozzi A/B e diametro foro max

descrizione	disassamento massimo		spostamento assiale
	angolare ka (Δ)	radiale Kr (mm)	S (mm)
GEB 19-24	1,2°	0,20	1,2
GEB 24-32	0,9°	0,22	1,4
GEB 28-38	0,9°	0,25	1,5
GEB 38-45	1,0°	0,28	1,8
GEB 42-55	1,0°	0,32	2,0
GEB 48-60	1,1°	0,36	2,1
GEB 55-70	1,1°	0,38	2,2
GEB 65-75	1,2°	0,42	2,6
GEB 75-90	1,2°	0,48	3,0
GEB 90-100	1,2°	0,50	3,4

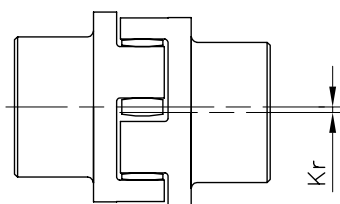

disassamento radiale

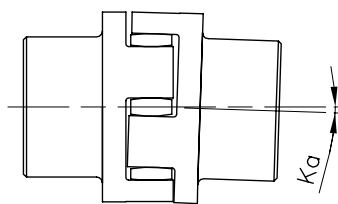

disassamento angolare

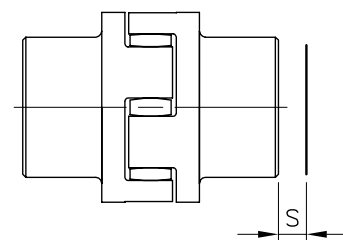

spostamento assiale



DIMENSIONAMENTO DEL GIUNTO "GEB" IN FUNZIONE DEL MOTORE DIMENSIONING OF THE COUPLING "GEB" ON THE BASIS OF THE ENGINE

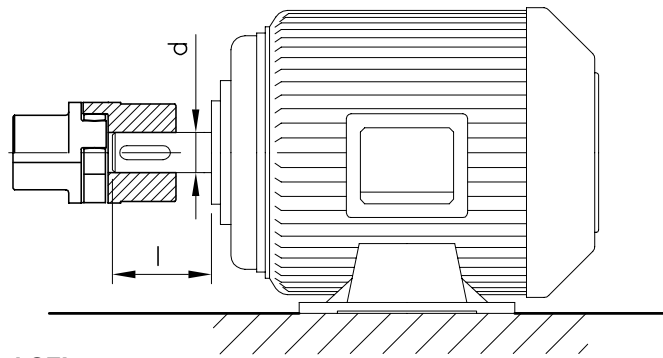

Giunti GEB per motori normalizzati CEI

Tipo	Potenza motore a 50 Hz 3000 (giri/1')		Potenza motore a 50 Hz 1500 (giri/1')		Potenza motore a 50 Hz 1000 (giri/1')		Potenza motore a 50 Hz 750 (giri/1')		Potenza motore a 50 Hz 3000 (giri/1')		Potenza motore a 50 Hz 1500 (giri/1')		Potenza motore a 50 Hz 1000 (giri/1')		Potenza motore a 50 Hz 750 (giri/1')		d x l [mm]		
	KW [kW]	T [Nm]	Tipo	K	KW [kW]	T [Nm]	Tipo	K	KW [kW]	T [Nm]	Tipo	K	KW [kW]	T [Nm]	Tipo	K	Tipo	K	
80	0,75	2,5	19/24	9,2	0,55	3,7	19/24	6,2	0,37	3,9	19/24	5,8	0,18	2,5	19/24	9,2	6,5	19 x 40	
	1,1	3,7		6,2	0,75	5,1		4,5	0,55	5,8		3,9	0,25	3,5		6,5			
90 S	1,5	5	19/24	4,6	1,1	7,5	19/24	3	0,75	8	19/24	2,8	0,37	5,3	19/24	4,3	24 x 50		
90 L	2,2	7,4		3,1	1,5	10		2,3	1,1	12		6,6	0,55	7,9		2,9			
100 L	3	9,8	24/32	8,1	2,2	15	24/32	5,3	1,5	15	24/32	5,3	0,75	11	24/32	7,2	24 x 60		
112 M	4	13		6,1	4	27		2,9	2,2	22		3,6	1,5	21		3,8			
132 S	5,5	18	28/38	12,7	5,5	36	28/38	6,3	3	30	28/38	7,6	2,2	30	28/38	7,6	38 x 80		
132 M	7,5	25		9,2	7,5	49		4,6	4	40		5,7	3	40		5,7			
160 M	11	36	38/45	12,5	11	72	38/45	6,2	7,5	74	38/45	6	4	54	38/45	8,3	42 x 110		
160 L	15	49		9,1	15	98		4,5	11	108		4,1	5,5	74		6			
180 M	18,5	60	42/55	7,5	18,5	121	42/55	4,3	15	148	42/55	4,1	11	145	42/55	4,2	48 x 110		
180 L	22	71		8,7	22	144		5,1	18,5	181		3,4	15	198		3,1			
200 L	30	97	42/55	6,3	30	196	42/55	3,1	22	215	42/55	2,8	15	198	42/55	3,1	55 x 110		
225 S	37	120		5,1	37	240		3	22	215		2,8	15	198		3,1			
225 M	45	145	48/60	4,2	45	292	48/60	2,4	30	293	48/60	2,4	18,5	244	48/60	2,9	55x110	60x140	
250 M	55	177		4	55	356		2,4	30	293		2,4	22	290		2,4	22	290	2,4
280 S	75	241	55/70	3,5	75	484	55/70	5,1	45	438	55/70	2,3	30	392	65	2,6	60x140	65x140	
280 M	90	289		2,9	90	581		2,4	37	361		2,3	30	392		2,6	60x140	65x140	
315 S	110	353	75/90	2,4	110	707	75/90	3,5	75	727	75/90	3,4	55	712	75/90	3,5	65x140		
315 M	132	423		2,4	110	707		2,9	90	873		2,8	75	971		6,2			
315 L	160	513	75/90	4,8	160	1.030	90/100	5,9	110	1.070	90	5,7	90	1.170	90	5,2	80x170		
315 L	200	641		3,9	200	1.290		4,7	132	1.280		4,7	110	1.420		4,2			
355 L	250	801	90/100	3,1	250	1.610	90/100	3,7	160	1.550	90/100	3,9	132	1.710	90/100	3,5	75x140		
355 L	315	1.010		6	315	2.020		3	250	2.420		2,5	200	2.580		2,3			200
400 L	355	1.140	90/100	5,3	355	2.280	100	2,6	315	3.040	100	2	250	3.220	100	1,8	80x170	100x120	
400 L	400	1.280		4,7	400	2.560		2,3	315	3.040		2	250	3.220		1,8	80x170	100x120	

Legenda

- KW** Potenza nominale del motore al numero di giri indicato [kW]
- T** Coppia nominale del motore al numero di giri indicato [Nm]
- K** Coefficiente di sicurezza
- d x l** Terminale dell'albero motore [mm]



GIUNTI ELASTICI SENZA GIOCO - "GEB SG" FLEXIBLE COUPLINGS BACKLASH - "GEB SG"

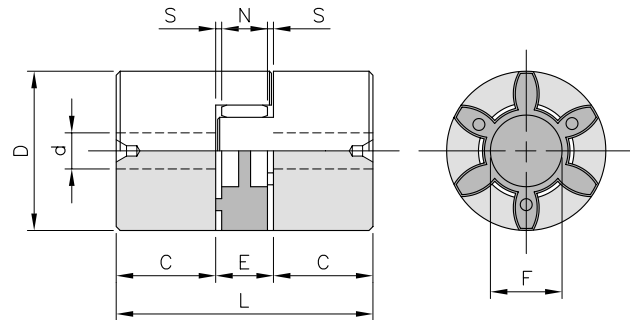

Materiale: Alluminio

descrizione	codice	Foro (d)		DIMENSIONI MOZZO							
		min. mm	max mm	C mm	D mm	E ⁽¹⁾ mm	F mm	N mm	S mm	L mm	Kg.
GEB SG 9	GEBSG009	4	10	10	20	10	7,2	8	1,0	30	0,013
GEB SG 14	GEBSG014	4	16	11	30	13	10,5	10	1,5	35	0,014
GEB SG 19-24	GEBSG019	8	20	25	40	16	18,0	12	2,0	66	0,110

(1) Quote di montaggio

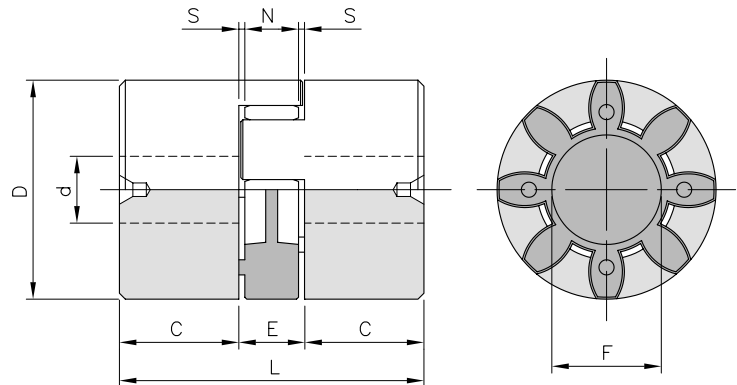
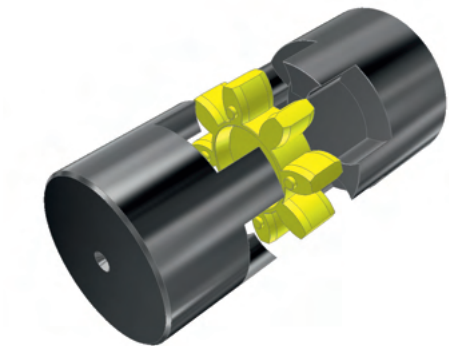

Materiale: Alluminio

descrizione	codice	Foro (d)		DIMENSIONI MOZZO							
		min. mm	max mm	C mm	D mm	E ⁽¹⁾ mm	F mm	N mm	S mm	L mm	Kg.
GEB SG 24-28	GEBSG024	12	28	30	55	18	27	14	2,0	78	0,23
GEB SG 28-38	GEBSG028	18	35	35	65	20	30	15	2,5	90	0,37
GEB SG 38-45	GEBSG038	18	45	45	80	24	38	18	3,0	114	0,70

(1) Quote di montaggio



GIUNTI ELASTICI SENZA GIOCO CON FORO FINITO - "GEB SG" FLEXIBLE COUPLINGS BACKLASH WITH FINISHED BORE - "GEB SG"

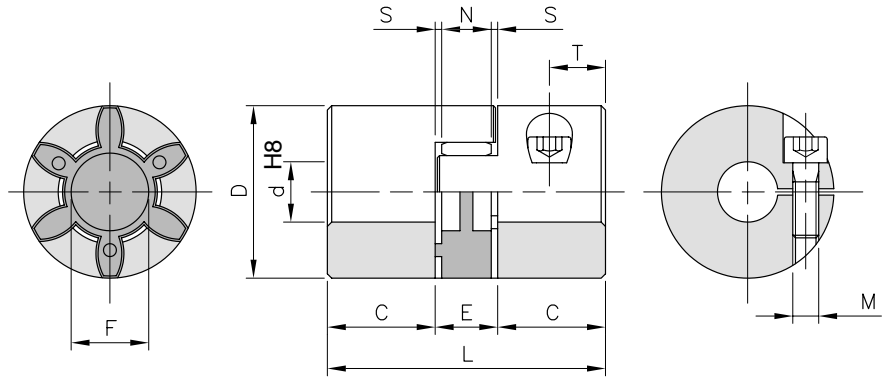

Materiale: Alluminio

descrizione	codice (+ Ø foro)	Foro (d)		DIMENSIONI MOZZO							viti di serraggio		
		min. mm	max mm	C mm	D mm	E ⁽¹⁾ mm	F mm	N mm	S mm	L mm	M	T mm	Ms Nm
GEB SG 9 FF	GEBSGFF0090--	4	10	10	20	10	7,2	8	1,0	30	M2,5x8	5	0,7
GEB SG 14 FF	GEBSGFF0140--	5	16	11	30	13	10,5	10	1,5	35	M3x14	5	1,4
GEB SG 19-24 FF	GEBSGFF0190--	8	20	25	40	16	18,0	12	2,0	66	M6x18	12	11,0

descrizione	COPPIA TRASMISSIBILE (Nm)																									
	DIAMETRO FORI PRODOTTI (d) H8																									
	04	05	06	07	08	09	10	11	12	14	15	16	18	19	20	22	24	25	28	30	32	35	38	40	42	45
GEB SG 9 FF	1,45	1,55	1,63	1,71	1,79	1,86	1,94																			
GEB SG 14 FF	3,32	3,43	3,55	3,67	3,79	3,91	4,02	4,14	4,38	4,5	4,6															
GEB SG 19-24 FF					18	19	19,5	20	21	21,5	22	22,5	23	24												

(1) Quote di montaggio

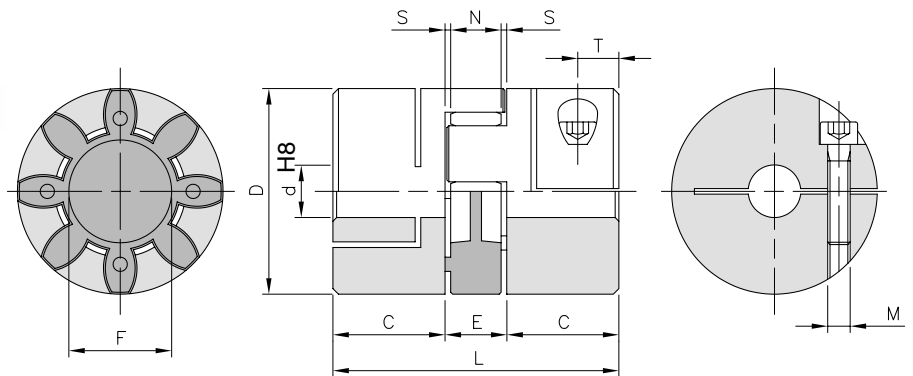

Materiale: Alluminio

descrizione	codice (+ Ø foro)	Foro (d)		DIMENSIONI MOZZO							viti di serraggio		
		min. mm	max mm	C mm	D mm	E ⁽¹⁾ mm	F mm	N mm	S mm	L mm	M	T mm	Ms Nm
GEB SG 24-28 FF	GEBSGFF0240--	10	28	30	55	18	27	14	2,0	78	M6x22	12	11,0
GEB SG 28-38 FF	GEBSGFF0280--	14	38	35	65	20	30	15	2,5	90	M8x25	13	25,0
GEB SG 38-45 FF	GEBSGFF0380--	15	45	45	80	24	38	18	3,0	114	M8x35	16	25,0

descrizione	COPPIA TRASMISSIBILE (Nm)																									
	DIAMETRO FORI PRODOTTI (d) H8																									
	04	05	06	07	08	09	10	11	12	14	15	16	18	19	20	22	24	25	28	30	32	35	38	40	42	45
GEB SG 24-28 FF						23	24	25	26	27	27,5	28	28,5	29	30	31	32	33								
GEB SG 28-38 FF										56	58	59	60	61	62	63	65	66	69	71	73	75	77			
GEB SG 38-45 FF											66	67	69	70	71	73	74	75	78	80	81	84	87	88	90	93

(1) Quote di montaggio



GIUNTI ELASTICI TORSIONALI - "GEB SG" TORSIONAL FLEXIBLE COUPLINGS - "GEB SG"

Elemento dentato elastico in poliuretano (colore BLU) - "80 Shore A"

descrizione	codice	Giri / 1' max	Momenti torcenti (Nm)		Kg.
			TK normale	TK max	
GEB SG 9	ELSGB009	28.000	1,8	3,6	0,002
GEB SG 14	ELSGB014	19.000	4,0	8,0	0,005
GEB SG 19-24	ELSGB019	14.000	4,9	9,8	0,007
GEB SG 24-28	ELSGB024	10.600	17,0	34,0	0,018
GEB SG 28-38	ELSGB028	8.500	46,0	92,0	0,029
GEB SG 38-45	ELSGB038	7.100	96,0	188,0	0,049



Elemento dentato elastico in poliuretano (colore GIALLO) - "92 Shore A"

descrizione	codice	Giri / 1' max	Momenti torcenti (Nm)		Kg.
			TK normale	TK max	
GEB SG 9	ELSGG009	28.000	3,0	6,0	0,002
GEB SG 14	ELSGG014	19.000	7,5	15,0	0,005
GEB SG 19-24	ELSGG019	14.000	10,0	20,0	0,007
GEB SG 24-28	ELSGG024	10.600	35,0	70,0	0,018
GEB SG 28-38	ELSGG028	8.500	95,0	190,0	0,029
GEB SG 38-45	ELSGG038	7.100	190,0	380,0	0,049

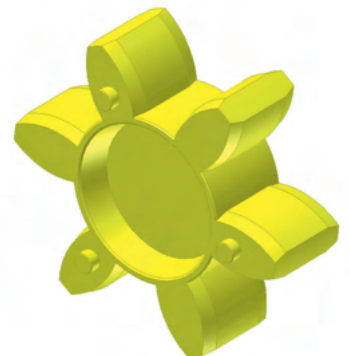

Elemento dentato elastico in poliuretano (colore ROSSO) - "98 Shore A"

descrizione	codice	Giri / 1' max	Momenti torcenti (Nm)		Kg.
			TK normale	TK max	
GEB SG 9	ELSGR009	28.000	5,0	10,0	0,002
GEB SG 14	ELSGR014	19.000	12,5	25,0	0,005
GEB SG 19-24	ELSGR019	14.000	17,0	34,0	0,007
GEB SG 24-28	ELSGR024	10.600	60,0	120,0	0,018
GEB SG 28-38	ELSGR028	8.500	160,0	320,0	0,029
GEB SG 38-45	ELSGR038	7.100	325,0	650,0	0,049

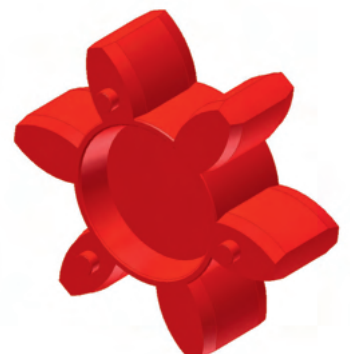



GIUNTI ELASTICI TORSIONALI - "GEB HRC" TORSIONAL FLEXIBLE COUPLINGS - "GEB HRC"

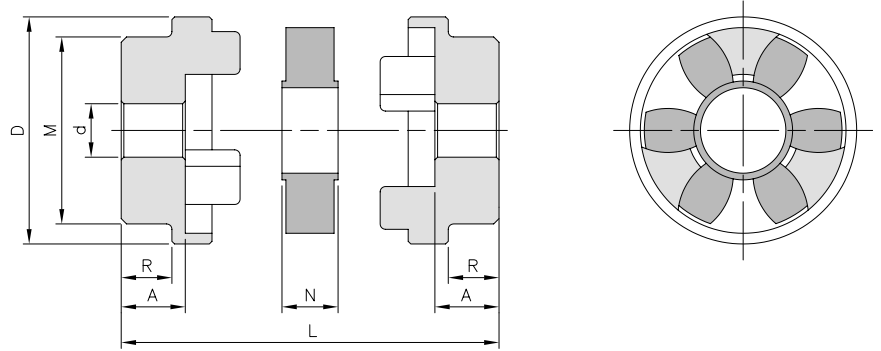

Materiale: Ghisa GG25

descrizione	codice	Preforo	Foro	DIMENSIONI						
		(d) mm	max mm	A mm	D mm	M mm	N mm	R mm	L mm	Kg.
GEB HRC 70	GEBHRC070	10	32	23,5	69	60	18,0	20,0	65,0	0,60
GEB HRC 90	GEBHRC090	10	42	30,0	85	70	22,5	26,0	82,5	1,07
GEB HRC 110	GEBHRC110	10	55	45,0	112	100	29,0	37,0	119,0	3,05
GEB HRC 130	GEBHRC130	20	60	47,5	130	105	35,0	39,0	130,0	4,45
GEB HRC 150	GEBHRC150	20	70	56,0	150	115	40,0	46,0	152,0	6,10
GEB HRC 180	GEBHRC180	28	80	70,0	180	125	46,0	58,0	186,0	9,20
GEB HRC 230	GEBHRC230	45	100	90,0	225	155	58,0	77,0	238,0	17,75
GEB HRC 280	GEBHRC280	55	115	105,5	275	206	72,0	90,0	283,0	35,75



GIUNTI ELASTICI TORSIONALI PER BUSSOLA CONICA - "GEB HRC TL" TORSIONAL FLEXIBLE COUPLINGS FOR TAPER BUSHES - "GEB HRC TL"

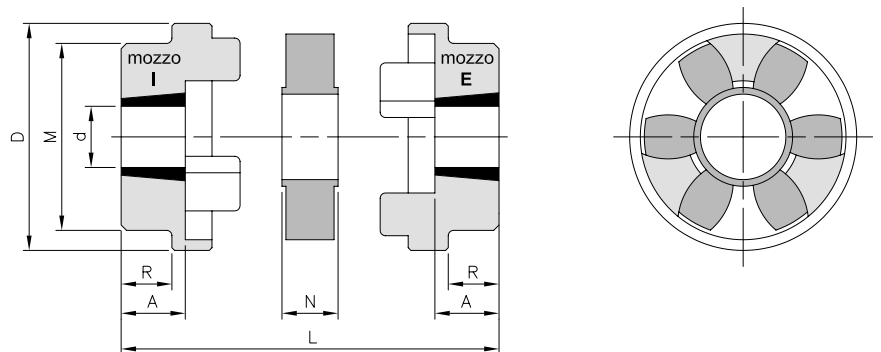

Materiale: Ghisa GG25

descrizione	codice		Bussola	Diametro Foro (d)		DIMENSIONI						
	mozzo E	mozzo I		min mm	max mm	A mm	D mm	M mm	N mm	R mm	L mm	Kg.
GEB HRC 70 TL	GEBHRCE070TL	GEBHRCI070TL	1008	11	25	23,5	69	60	18,0	20,0	65,0	0,44
GEB HRC 90 TL	GEBHRCE090TL	GEBHRCI090TL	1108	11	28	23,5	85	70	22,5	19,5	69,5	0,72
GEB HRC 110 TL	GEBHRCE110TL	GEBHRCI110TL	1610	12	42	26,5	112	100	29,0	18,5	82,0	1,60
GEB HRC 130 TL	GEBHRCE130TL	GEBHRCI130TL	1610	12	42	26,5	130	105	35,0	18,0	88,0	2,27
GEB HRC 150 TL	GEBHRCE150TL	GEBHRCI150TL	2012	15	50	33,5	150	115	40,0	23,5	107,0	3,30
GEB HRC 180 TL	GEBHRCE180TL	GEBHRCI180TL	2517	19	65	46,5	180	125	46,0	34,5	139,0	5,37
GEB HRC 230 TL	GEBHRCE230TL	GEBHRCI230TL	3020	25	75	52,5	225	155	58,0	39,5	163,0	9,53
GEB HRC 280 TL	GEBHRCE280TL	GEBHRCI280TL	3525	35	90	66,5	275	206	72,0	51,0	205,0	20,50



GIUNTI ELASTICI TORSIONALI - "GEB HRC" TORSIONAL FLEXIBLE COUPLINGS - "GEB HRC"

Elemento dentato elastico in gomma (colore NERO)

descrizione	codice	Giri / 1' max	Momenti torcenti (Nm)		Kg.
			TK normale	TK max	
GEB HRC 70	ELHRCN070	8.100	31	72	0,016
GEB HRC 90	ELHRCN090	6.500	80	180	0,050
GEB HRC 110	ELHRCN110	5.200	160	360	0,080
GEB HRC 130	ELHRCN130	4.100	315	720	0,150
GEB HRC 150	ELHRCN150	3.600	600	1.500	0,220
GEB HRC 180	ELHRCN180	3.000	950	2.350	0,380
GEB HRC 230	ELHRCN230	2.600	2.000	5.000	0,800
GEB HRC 280	ELHRCN280	2.200	3.150	7.200	1,530

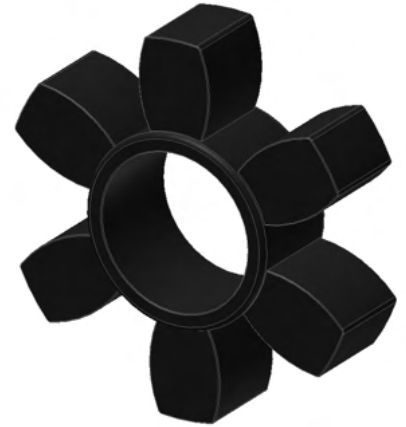

descrizione	disassamento ⁽¹⁾ massimo		spostamento assiale
	angolare ka (Δ)	radiale Kr (mm)	S (mm)
GEB HRC 70	1,0°	0,3	+0,2
GEB HRC 90	1,0°	0,3	+0,5
GEB HRC 110	1,0°	0,3	+0,6
GEB HRC 130	1,0°	0,4	+0,8
GEB HRC 150	1,0°	0,4	+0,9
GEB HRC 180	1,0°	0,4	+1,1
GEB HRC 230	1,0°	0,5	+1,3
GEB HRC 280	1,0°	0,5	+1,7

(1) Valori validi per n= 600 giri/min e considerati individualmente.

Per velocità superiori ai 600 giri /min si ha una riduzione dei valori di disassamento e spostamento.

≤ 0,8 601 - 1000 min-1, rpm

≤ 0,65 1001 - 1500 min-1, rpm

≤ 0,50 1501 - 3000 min-1, rpm

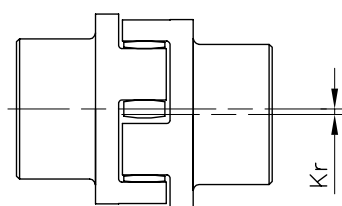

disassamento radiale

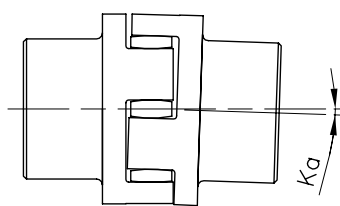

disassamento angolare

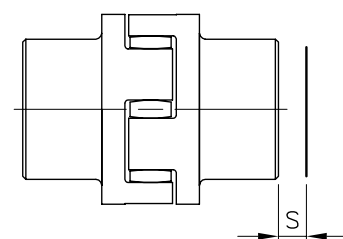

spostamento assiale



GIUNTI DENTATI - "GFB" GEAR COUPLINGS - "GFB"

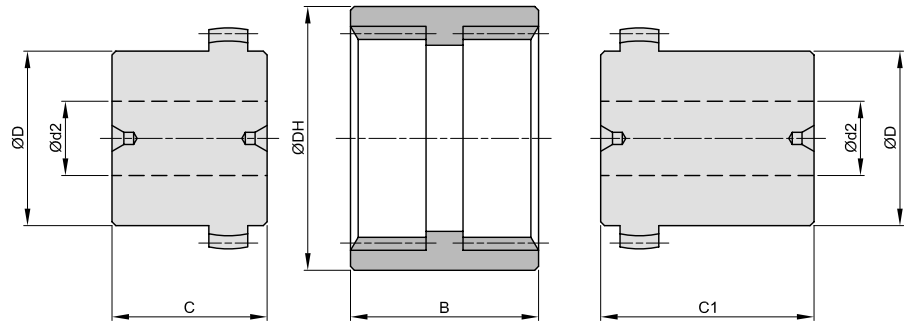
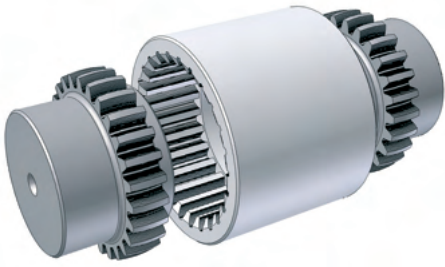

descrizione	foro Ød1 mm	foro MAX Ød2 mm	manicotto			mozzo standard				mozzo lungo				
			codice	ØDH mm	B mm	peso Kg.	codice	ØD mm	C mm	peso Kg.	codice	ØD mm	C1 mm	peso Kg.
GFB-14	-	15	550014000	40	37	0,02	550014100	24	23	0,09	550014200	24	40	0,15
GFB-19	-	20	550019000	48	37	0,03	550019100	30	25	0,15	550019200	30	40	0,23
GFB-24	-	24	550024000	52	41	0,04	550024100	36	26	0,22	550024200	36	50	0,40
GFB-28	-	28	550028000	66	46	0,07	550028100	44	40	0,50	550028200	44	55	0,69
GFB-32	-	32	550032000	76	48	0,09	550032100	50	40	0,67	550032200	50	55	0,90
GFB-38	-	38	550038000	83	48	0,11	550038100	58	40	0,80	550038200	58	60	1,30
GFB-42	-	42	550042000	92	50	0,14	550042100	65	42	1,17	550042200	65	60	1,60
GFB-48	-	48	550048000	95	50	0,16	550048100	67	50	1,43	550048200	67	60	1,70
GFB-65	23	65	550065000	132	68	0,37	550065100	96	55	3,20	550065200	96	70	4,05

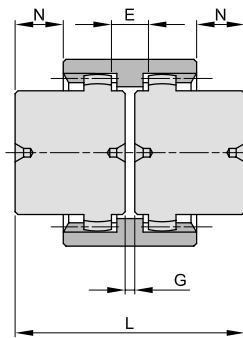

GFB-SS

2 mozzi standard

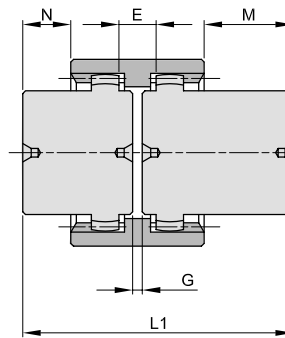

GFB-SL

1 mozzo standard
1 mozzo lungo

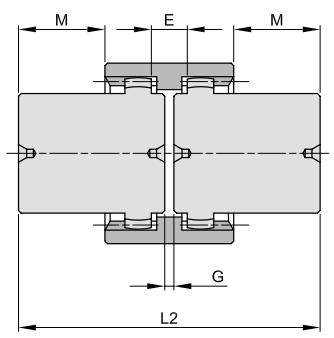

GFB-LL

2 mozzi lunghi

descrizione	G mm	E mm	M mm	N mm	GFB-SS		GFB-SL		GFB-LL	
					L mm	peso Kg.	L1 mm	peso Kg.	L2 mm	peso Kg.
GFB-14	4	15	23,5	6,5	50	0,20	67	0,26	84	0,32
GFB-19	4	20	23,5	8,5	54	0,33	69	0,41	84	0,49
GFB-24	4	24	31,5	7,5	56	0,48	80	0,66	104	0,84
GFB-28	4	28	34	19	84	1,07	99	1,26	114	1,45
GFB-32	4	32	33	18	84	1,43	99	1,66	114	1,89
GFB-38	4	38	38	18	84	1,71	104	2,21	124	2,71
GFB-42	4	42	37	19	88	2,48	106	2,91	124	3,34
GFB-48	4	48	37	27	104	3,02	114	3,29	124	3,56
GFB-65	4	65	38	23	114	6,77	129	7,62	144	8,47

Descrizione e caratteristiche

- Costituiti da due mozzi in acciaio ed un manicotto in resina poliammide dentato internamente;
- Permettono un'ottima compensazione negli spostamenti assiali, radiali ed angolari nel collegamento degli alberi;
- I giunti con dentatura bombata e l'accoppiamento acciaio-resina non richiedono alcuna manutenzione;
- Di facile montaggio sia in orizzontale che in verticale;
- Temperatura di impiego da -25° a +100°.



Characteristics

- Consist in two curved toothed hubs made in steel and one internally toothed sleeve made in polyamide;
- Able to compensate for axial, radial and angular misalignments of the connected shafts;
- Steel and polyamide combination makes maintenance-free;
- Easy to be mounted both in vertical and horizontal planes;
- Suitable for temperatures from -25° to +100°.

descrizione	coppia Nm		fattore di potenza $\frac{P}{n}$		potenza trasmissibile (KW giri/1')								giri/1'	J* Kg cm ²
	norm.	max	norm.	max	750		1000		1500		3000			
					norm.	max	norm.	max	norm.	max	norm.	max		
GFB-14	10	20	0,0010	0,0021	0,79	1,57	1,05	2,09	1,57	3,14	3,14	6,28	14000	0,3
GFB-19	16	32	0,0017	0,0034	1,26	2,51	1,68	3,35	2,51	5,03	5,03	10,05	11800	0,5
GFB-24	20	40	0,0021	0,0042	1,57	3,14	2,09	4,19	3,14	6,28	6,28	12,57	10600	1,0
GFB-28	45	90	0,0047	0,0094	3,53	7,07	4,71	9,42	7,07	14,14	14,14	28,27	8500	3,1
GFB-32	60	120	0,0063	0,0126	4,71	9,42	6,28	12,57	9,42	18,85	18,85	37,70	7500	5,5
GFB-38	80	160	0,0084	0,0168	6,28	12,57	8,38	16,75	12,57	25,13	25,13	50,26	6700	8,7
GFB-42	100	200	0,0105	0,0209	7,85	15,71	10,47	20,94	15,71	31,41	31,41	62,83	6000	14,3
GFB-48	140	280	0,0147	0,0293	10,99	21,99	14,66	29,32	21,99	43,98	43,98	87,96	5600	18,4
GFB-65	380	760	0,0398	0,0796	29,84	59,69	39,79	79,58	59,69	119,37	119,37	238,74	4000	109,0

*Momento d'inerzia riferito al giunto con mozzo standard con foro MAX (ϕd_2)

descrizione	disassamento massimo per ogni mozzo		spostamento assiale (mm)
	ka (Δ)	kr (mm)	
GFB-14	$\pm 2^\circ$	$\pm 0,3$	± 1
GFB-19	$\pm 2^\circ$	$\pm 0,4$	± 1
GFB-24	$\pm 2^\circ$	$\pm 0,4$	± 1
GFB-28	$\pm 2^\circ$	$\pm 0,5$	± 1
GFB-32	$\pm 2^\circ$	$\pm 0,5$	± 1
GFB-38	$\pm 2^\circ$	$\pm 0,5$	± 1
GFB-42	$\pm 2^\circ$	$\pm 0,5$	± 1
GFB-48	$\pm 2^\circ$	$\pm 0,5$	± 1
GFB-65	$\pm 2^\circ$	$\pm 0,6$	± 1

Norme di montaggio

- 1) Fissare i due mozzi agli alberi da accoppiare. La facciata interna del mozzo deve risultare a filo dell'estremità del rispettivo albero;
- 2) Infilare il manicotto sui due mozzi e regolare la distanza dei giunti come da quota "G";
- 3) Fissare in questa posizione i due alberi da accoppiare;
- 4) Accertarsi che il manicotto sia libero di spostarsi assialmente.

Mounting instructions

- 1) Fix the two hubs to the shafts. The inner sides of the hubs must be aligned with the shaft ends;
- 2) Insert the sleeve on the two hubs and adjust the distance of elements as per size "G";
- 3) Fix to this position the two elements to be coupled;
- 4) The sleeve must be free to move axially.

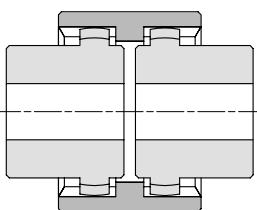

allineati

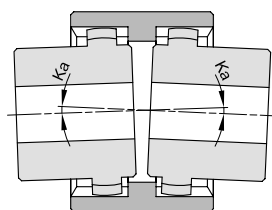

disassamento angolare

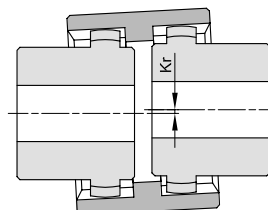

disassamento radiale

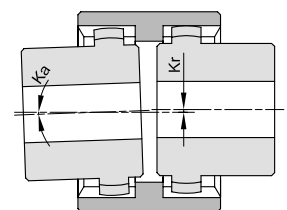

disassamento radiale/angolare



GIUNTI RIGIDI AD UNA SEZIONE CON CHIAVETTA - BRUNITI

RIGID COUPLING ONE SPLIT BORE AND KEYWAY - BLACK OXIDE

Momenti torcenti medio elevati

Tolleranza: albero h8

Superficie di contatto con rugosità: R_a max 16 μm

Montaggio e smontaggio rapido fra due alberi allineati

Massima velocità 4000 min^{-1}

Cave linguette secondo DIN 6885 / UNI 6604

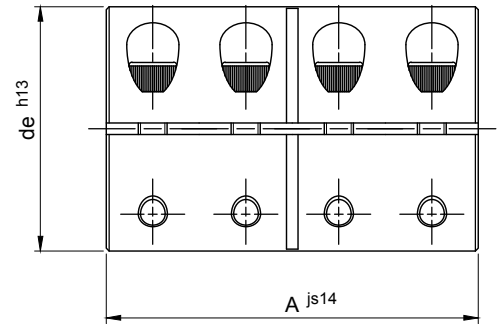
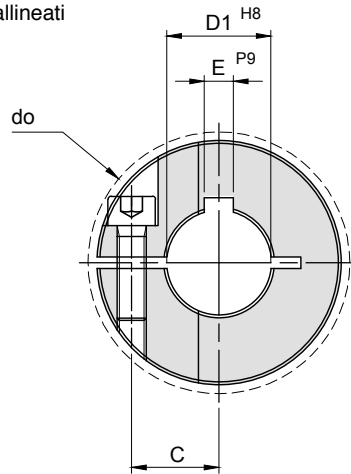

Materiale: Acciaio C-45

descrizione	codice	D1 mm	de mm	do mm	A mm	momento torcente Mt Nm	C mm	E mm	viti di serraggio			Kg.
									DIN 912 12,9 N°	coppia di serraggio Ms Nm tipo		
GBR 6	GBR006	6	18	21,5	30	30	5,9	2	4	M3 x 8	2,1	0,05
GBR 8	GBR008	8	24	27,1	35	50	9,0	2	4	M3 x 10	2,1	0,10
GBR 10	GBR010	10	29	33,0	45	100	10,6	3	4	M4 x 12	4,6	0,18
GBR 12	GBR012	12	29	33,0	45	100	10,6	4	4	M4 x 12	4,6	0,18
GBR 14	GBR014	14	34	39,4	50	190	12,0	5	4	M5 x 16	9,5	0,27
GBR 15	GBR015	15	34	39,4	50	190	12,0	5	4	M5 x 16	9,5	0,27
GBR 16	GBR016	16	34	39,4	50	190	12,0	5	4	M5 x 16	9,5	0,26
GBR 20	GBR020	20	42	48,9	65	350	15,4	6	4	M6 x 16	16,0	0,52
GBR 25	GBR025	25	45	51,5	75	390	16,9	8	4	M6 x 16	16,0	0,62
GBR 30	GBR030	30	53	58,7	83	475	20,9	8	4	M6 x 18	16,0	0,92
GBR 35	GBR035	35	67	74,7	95	1100	26,7	10	4	M8 x 25	39,0	1,88
GBR 40	GBR040	40	77	84,0	108	1325	31,8	12	4	M8 x 25	39,0	2,71
GBR 50	GBR050	50	85	94,2	124	2250	34,1	14	4	M10 x 25	77,0	3,52



GIUNTI RIGIDI A DUE SEZIONI CON CHIAVETTA - BRUNITI RIGID COUPLING TWO SPLIT BORE AND KEYWAY - BLACK OXIDE

Momenti torcenti medio elevati
Tolleranza: albero h8
Superficie di contatto con rugosità: R_a max 16 μm
Montaggio e smontaggio rapido fra due alberi allineati
Massima velocità 4000 min^{-1}
Cave linguette secondo DIN 6885 / UNI 6604

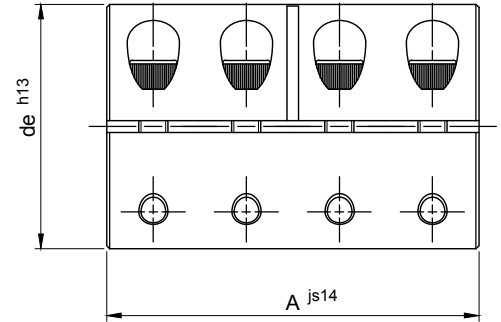
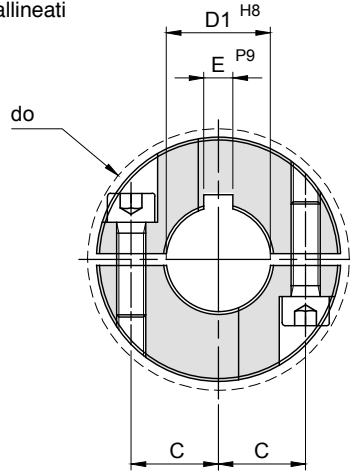

Materiale: Acciaio C-45

descrizione	codice	D1 mm	de mm	do mm	A mm	momento torcente Mt Nm	C mm	E mm	viti di serraggio			Kg.
									DIN 912 12,9		coppia di serraggio Ms Nm	
									N°	tipo		
GBRR 6	GBRR006	6	18	21,5	30	30	5,9	2	8	M3 x 8	2,1	0,05
GBRR 8	GBRR008	8	24	27,1	35	50	9,0	2	8	M3 x 10	2,1	0,10
GBRR 10	GBRR010	10	29	33,0	45	100	10,6	3	8	M4 x 12	4,6	0,18
GBRR 12	GBRR012	12	29	33,0	45	100	10,6	4	8	M4 x 12	4,6	0,18
GBRR 14	GBRR014	14	34	39,4	50	190	12,0	5	8	M5 x 16	9,5	0,27
GBRR 15	GBRR015	15	34	39,4	50	190	12,0	5	8	M5 x 16	9,5	0,27
GBRR 16	GBRR016	16	34	39,4	50	190	12,0	5	8	M5 x 16	9,5	0,26
GBRR 20	GBRR020	20	42	48,9	65	350	15,4	6	8	M6 x 16	16,0	0,52
GBRR 25	GBRR025	25	45	51,5	75	390	16,9	8	8	M6 x 16	16,0	0,62
GBRR 30	GBRR030	30	53	58,7	83	475	20,9	8	8	M6 x 18	16,0	0,92
GBRR 35	GBRR035	35	67	74,7	95	1100	26,7	10	8	M8 x 25	39,0	1,88
GBRR 40	GBRR040	40	77	84,0	108	1325	31,8	12	8	M8 x 25	39,0	2,71
GBRR 50	GBRR050	50	85	94,2	124	2250	34,1	14	8	M10 x 25	77,0	3,52



GIUNTI RIGIDI AD UNA SEZIONE CON CHIAVETTA - INOX

RIGID COUPLING ONE SPLIT BORE AND KEYWAY - STAINLESS STEEL

Momenti torcenti medio elevati

Tolleranza: albero h8

Superficie di contatto con rugosità: R_a max 16 μm

Montaggio e smontaggio rapido fra due alberi allineati

Massima velocità 4000 min^{-1}

Cave linguette secondo DIN 6885 / UNI 6604

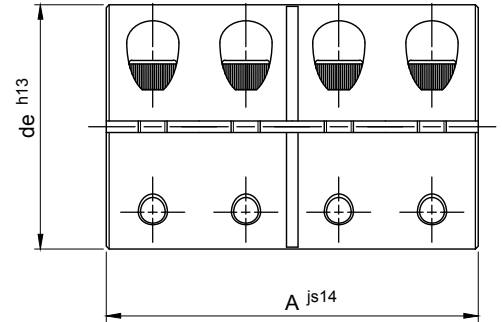
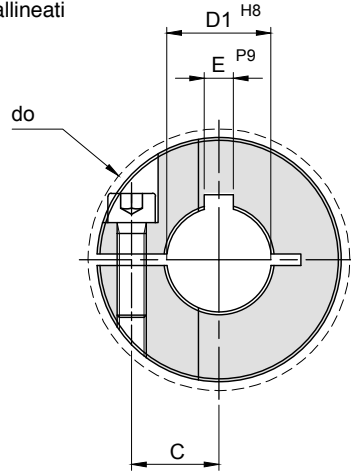

Materiale: INOX AISI 304

descrizione	codice	D1 mm	de mm	do mm	A mm	momento torcente Mt Nm	C mm	E mm	viti di serraggio			Kg.
									DIN 912 A2-70 N°	coppia di serraggio Ms Nm	tipo	
GBR 6	SSGBR006	6	18	21,5	30	25	5,9	2	4	M3 x 8	1,1	0,05
GBR 8	SSGBR008	8	24	27,1	35	40	9,0	2	4	M3 x 10	1,1	0,10
GBR 10	SSGBR010	10	29	33,0	45	90	10,6	3	4	M4 x 12	2,5	0,18
GBR 12	SSGBR012	12	29	33,0	45	90	10,6	4	4	M4 x 12	2,5	0,18
GBR 14	SSGBR014	14	34	39,4	50	160	12,0	5	4	M5 x 16	5,4	0,27
GBR 15	SSGBR015	15	34	39,4	50	160	12,0	5	4	M5 x 16	5,4	0,27
GBR 16	SSGBR016	16	34	39,4	50	160	12,0	5	4	M5 x 16	5,4	0,26
GBR 20	SSGBR020	20	42	48,9	65	300	15,4	6	4	M6 x 16	9,6	0,52
GBR 25	SSGBR025	25	45	51,5	75	325	16,9	8	4	M6 x 16	9,6	0,62
GBR 30	SSGBR030	30	53	58,7	83	400	20,9	8	4	M6 x 18	9,6	0,92
GBR 35	SSGBR035	35	67	74,7	95	925	26,7	10	4	M8 x 25	23,0	1,88
GBR 40	SSGBR040	40	77	84,0	108	1100	31,8	12	4	M8 x 25	23,0	2,71
GBR 50	SSGBR050	50	85	94,2	124	1875	34,1	14	4	M10 x 25	46,0	3,52



GIUNTI RIGIDI A DUE SEZIONI CON CHIAVETTA - INOX

RIGID COUPLING TWO SPLIT BORE AND KEYWAY - STAINLESS STEEL

Momenti torcenti medio elevati
 Tolleranza: albero h8
 Superficie di contatto con rugosità: R_a max 16 μm
 Montaggio e smontaggio rapido fra due alberi allineati
 Massima velocità 4000 min^{-1}
 Cave linguette secondo DIN 6885 / UNI 6604

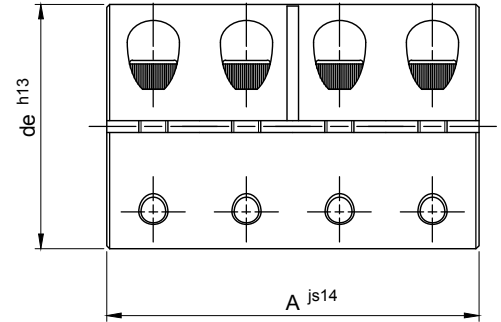
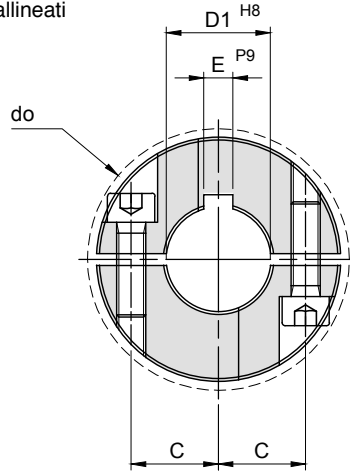

Materiale: INOX AISI 304

descrizione	codice	D1 mm	de mm	do mm	A mm	momento torcente Mt Nm	C mm	E mm	viti di serraggio			Kg.
									DIN 912 A2-70 N°	coppia di serraggio Ms Nm	tipo	
GBRR 6	SSGBRR006	6	18	21,5	30	25	5,9	2	8	M3 x 8	1,1	0,05
GBRR 8	SSGBRR008	8	24	27,1	35	40	9,0	2	8	M3 x 10	1,1	0,10
GBRR 10	SSGBRR010	10	29	33,0	45	90	10,6	3	8	M4 x 12	2,5	0,18
GBRR 12	SSGBRR012	12	29	33,0	45	90	10,6	4	8	M4 x 12	2,5	0,18
GBRR 14	SSGBRR014	14	34	39,4	50	160	12,0	5	8	M5 x 16	5,4	0,27
GBRR 15	SSGBRR015	15	34	39,4	50	160	12,0	5	8	M5 x 16	5,4	0,27
GBRR 16	SSGBRR016	16	34	39,4	50	160	12,0	5	8	M5 x 16	5,4	0,26
GBRR 20	SSGBRR020	20	42	48,9	65	300	15,4	6	8	M6 x 16	9,6	0,52
GBRR 25	SSGBRR025	25	45	51,5	75	325	16,9	8	8	M6 x 16	9,6	0,62
GBRR 30	SSGBRR030	30	53	58,7	83	400	20,9	8	8	M6 x 18	9,6	0,92
GBRR 35	SSGBRR035	35	67	74,7	95	925	26,7	10	8	M8 x 25	23,0	1,88
GBRR 40	SSGBRR040	40	77	84,0	108	1100	31,8	12	8	M8 x 25	23,0	2,71
GBRR 50	SSGBRR050	50	85	94,2	124	1875	34,1	14	8	M10 x 25	46,0	3,52



GIUNTI FLESSIBILI A CATENA - DIN 8187

CHAIN COUPLINGS - DIN 8187

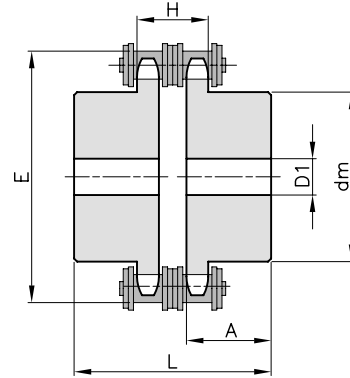

Materiale: Acciaio C45

descrizione	codice	catena		Z	dm mm	D1 mm	A mm	E mm	L mm	H mm	Kg.
		ISO	mm								
GC 06 14	GC109014	06B-2	9,525	14/14	31	8	25	51,0	55,0	15,6	0,42
GC 06 18	GC109018	06B-2	9,525	18/18	43	10	28	63,1	61,0	15,6	0,79
GC 08 14	GC112014	08B-2	12,7	14/14	41	10	28	68,9	62,7	21,1	0,88
GC 08 18	GC112018	08B-2	12,7	18/18	56	12	28	85,0	62,7	21,1	1,49
GC 10 18	GC115018	10B-2	15,875	18/18	70	14	30	106,2	67,5	25,7	2,52
GC 12 18	GC119018	12B-2	19,05	18/18	80	16	35	125,8	78,4	30,6	4,01
GC 12 24	GC119024	12B-2	19,05	24/24	90	20	40	162,1	88,4	30,6	6,39
GC 16 18	GC125018	16B-2	25,4	18/18	100	20	45	167,3	105,7	48,1	9,44
GC 16 24	GC125024	16B-2	25,4	24/24	110	20	50	215,6	115,7	48,1	14,82

Altri tipi di catene, numeri di denti e versioni con foro finito e tempera induzione sui denti fornibili su richiesta / Other types of chains, tooth numbers and versions with finished bore and hardened teeth on request

Fattori di carico dinamico (K)

tipo di carico	tipo di motore		
	motore elettrico	motore a combustione	
		4 cilindri o superiore	meno di 4 cilindri
regolare	1,0	1,5	2,0
irregolare	1,5	2,0	2,5
a strappi	2,0	2,5	3,0

Scelta del Giunto a Catena

Avendo la potenza del motore e il numero di giri, moltiplicare la potenza del motore (Nm) per il fattore di carico (K) per ottenere la potenza effettiva (kW). Ottenuta la potenza effettiva dividerla per il numero dei giri del motore (rpm) per ottenere il rapporto di trasmissione (P/n). Con il valore ottenuto tramite la tabella della potenza trasmissibile scegliere il giunto più adatto.

Choice of Chain Coupling

Having the engine power and the number of revolutions, multiply the engine power (Nm) to the load factor (K) to obtain the effective power (kW). Obtained the actual power divide it by the number of revolutions of the engine (rpm) to obtain the transmission ratio (P / n). With the value obtained using the table of power rating to choose the most suitable joint.

Esempio - Example

- Tipo di motore : Motore diesel a 4 cilindri
- Fattore di carico : Regolare (K) = 1,5
- Potenza motore : P = 110 kW
- Numero giri : n = 1400 rpm

$$P \text{ eff.} = P \times K = 110 \times 1,5 = 165 \text{ kW}$$

$$\frac{P}{n} = \frac{P \text{ eff.}}{\text{rpm}} = \frac{165}{1400} = 0,1178$$

Il Giunto a Catena successivo come dimensione è GC 1618
The coupling next in size is GC 1618

descrizione	Mt	$\frac{P}{n}$
	Nm	kW/rpm
GC 06 14	60	0,0062
GC 06 18	95	0,0097
GC 08 14	150	0,0154
GC 08 18	240	0,0246
GC 10 18	380	0,0246
GC 12 18	600	0,0616
GC 12 24	940	0,0965
GC 16 18	1480	0,1519
GC 16 24	2350	0,2413

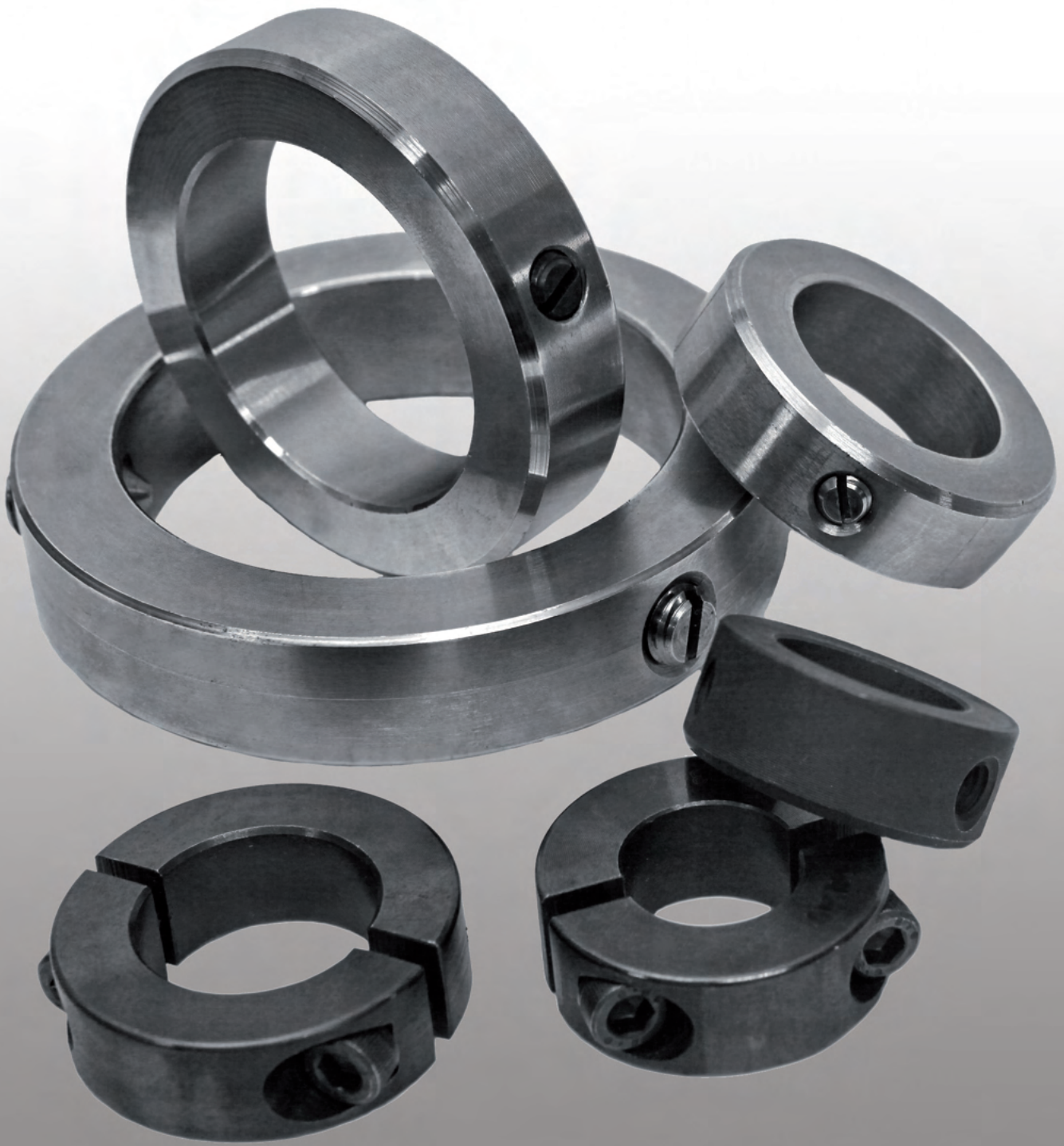



ANELLI DI BLOCCAGGIO SECONDO DIN 705 - BRUNITI

SHAFT COLLARS WITH SCREW DIN 705 - BLACK OXIDE

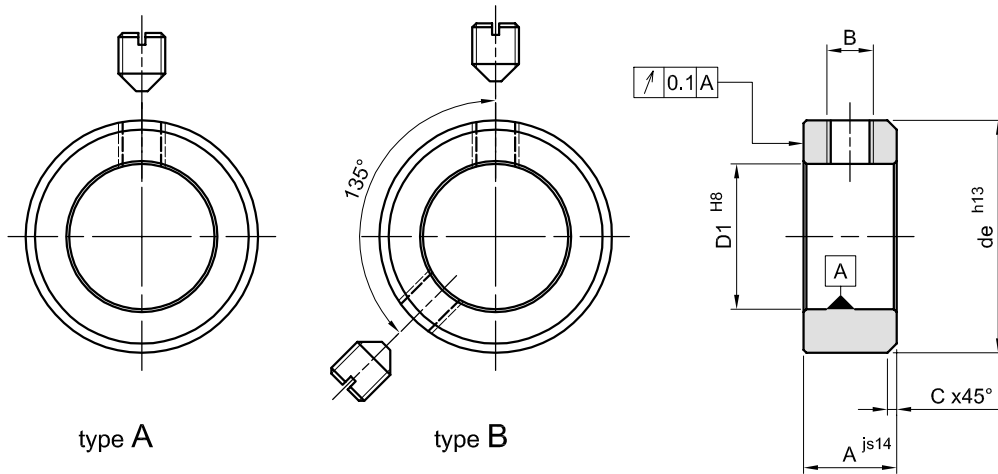

Con viti ad intaglio a punta conica - DIN 553
Slotted set screws with cone point - DIN 553

Materiale: Acciaio C-45

descrizione	codice	tipo	D1 mm	de mm	A mm	B mm	C mm	Kg./100 pcs
AB 3	AB003	A	3	7	5	M2 x 3	0,5	0,12
AB 4	AB004	A	4	8	5	M2,5 x 3	0,5	0,15
AB 5	AB005	A	5	10	6	M3 x 4	0,6	0,28
AB 6	AB006	A	6	12	8	M4 x 5	0,8	0,54
AB 7	AB007	A	7	12	8	M4 x 5	0,8	0,48
AB 8	AB008	A	8	16	8	M4 x 6	0,8	0,94
AB 9	AB009	A	9	18	10	M5 x 8	1,0	1,51
AB 10	AB010	A	10	20	10	M5 x 8	1,0	1,85
AB 12	AB012	A	12	22	12	M6 x 8	1,2	2,52
AB 14	AB014	A	14	25	12	M6 x 8	1,2	3,17
AB 15	AB015	A	15	25	12	M6 x 8	1,2	2,98
AB 16	AB016	A	16	28	12	M6 x 8	1,2	3,84
AB 17	AB017	A	17	28	12	M6 x 8	1,2	4,00
AB 18	AB018	A	18	32	14	M6 x 8	1,4	6,00
AB 20	AB020	A	20	32	14	M6 x 8	1,4	5,30
AB 22	AB022	A	22	36	14	M6 x 10	1,4	6,90
AB 25	AB025	A	25	40	16	M8 x 10	1,6	9,56
AB 30	AB030	A	30	45	16	M8 x 10	1,6	11,10
AB 35	AB035	A	35	56	16	M8 x 12	1,6	18,70
AB 40	AB040	A	40	63	18	M10 x 16	1,8	26,10
AB 45	AB045	A	45	70	18	M10 x 16	1,8	31,70
AB 50	AB050	A	50	80	18	M10 x 16	1,8	42,90
AB 55	AB055	A	55	80	18	M10 x 16	1,8	37,30
AB 60	AB060	A	60	90	20	M10 x 16	2,0	55,20
AB 65	AB065	A	65	100	20	M10 x 20	2,0	70,80
AB 70	AB070	A	70	100	20	M10 x 20	2,0	62,60
AB 80	AB080	B	80	110	22	M12 x 20	2,2	76,80
AB 90	AB090	B	90	125	22	M12 x 20	2,2	101,00
AB 100	AB100	B	100	140	25	M12 x 25	2,5	147,00



ANELLI DI BLOCCAGGIO CON COLLARE - BRUNITI

SHAFT COLLARS WITH ONE SIDE HUB - BLACK OXIDE

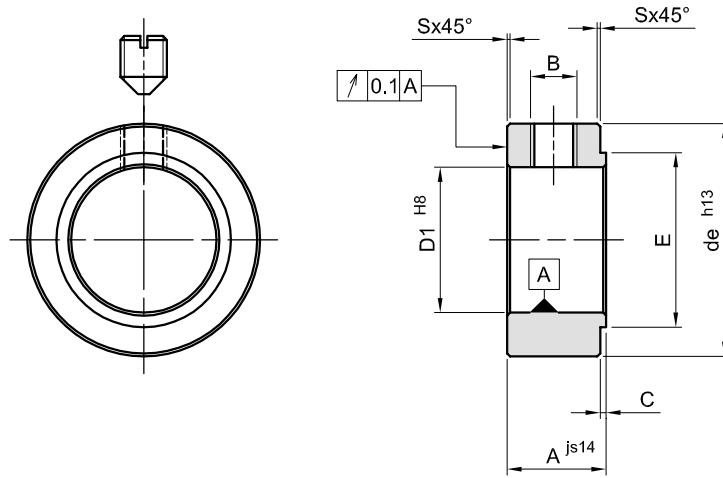

Con viti ad intaglio a punta conica - DIN 553
Slotted set screws with cone point - DIN 553

Materiale: Acciaio C-45

descrizione	codice	D1 mm	de mm	A mm	B mm	C mm	E mm	S mm	Kg./100 pcs
ABC 6	ABC006	6	12	8	M4 x 5	0,6	8	0,3	0,54
ABC 8	ABC008	8	16	8	M4 x 6	0,8	10	0,3	0,94
ABC 10	ABC010	10	20	10	M5 x 8	0,8	13	0,3	1,85
ABC 12	ABC012	12	22	12	M6 x 8	0,8	15	0,5	2,52
ABC 15	ABC015	15	25	12	M6 x 8	1,0	18	0,6	2,98
ABC 17	ABC017	17	28	12	M6 x 8	1,0	20	0,6	4,00
ABC 20	ABC020	20	32	14	M6 x 8	1,0	24	0,8	5,30
ABC 25	ABC025	25	40	16	M8 x 10	1,0	29	0,8	9,56
ABC 30	ABC030	30	45	16	M8 x 10	1,2	34	1,0	11,10
ABC 35	ABC035	35	56	16	M8 x 12	1,2	39	1,0	18,70
ABC 40	ABC040	40	63	18	M10 x 16	1,2	44	1,0	26,10



ANELLI A BLOCCAGGIO RADIALE AD UNA SEZIONE - BRUNITI

SHAFT COLLARS ONE SPLIT - BLACK OXIDE

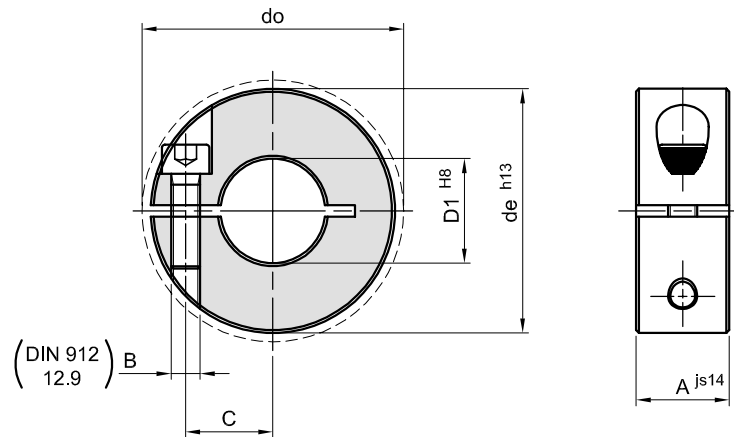

Materiale: Acciaio C-45

descrizione	codice	D1 mm	de mm	do mm	A mm	B mm	C mm	Kg.
ABR 4	ABR004	4	16	20,7	9	M3 x 8	5,5	0,011
ABR 5	ABR005	5	16	20,7	9	M3 x 8	5,5	0,010
ABR 6	ABR006	6	16	20,7	9	M3 x 8	5,5	0,010
ABR 8	ABR008	8	18	22,4	9	M3 x 8	6,5	0,012
ABR 10	ABR010	10	24	26,0	9	M3 x 8	8,5	0,022
ABR 12	ABR012	12	28	31,8	11	M4 x 12	10,0	0,038
ABR 14	ABR014	14	30	33,9	11	M4 x 12	11,0	0,042
ABR 15	ABR015	15	34	39,4	13	M5 x 14	12,5	0,065
ABR 16	ABR016	16	34	39,4	13	M5 x 14	12,5	0,063
ABR 18	ABR018	18	36	41,2	13	M5 x 14	13,5	0,069
ABR 19	ABR019	19	40	46,4	15	M6 x 16	14,7	0,100
ABR 20	ABR020	20	40	46,4	15	M6 x 16	14,7	0,097
ABR 22	ABR022	22	42	48,1	15	M6 x 16	16,0	0,103
ABR 23	ABR023	23	45	50,8	15	M6 x 16	17,5	0,122
ABR 24	ABR024	24	45	50,8	15	M6 x 16	17,5	0,117
ABR 25	ABR025	25	45	50,8	15	M6 x 16	17,5	0,114
ABR 26	ABR026	26	48	53,7	15	M6 x 18	19,0	0,133
ABR 28	ABR028	28	48	53,7	15	M6 x 18	19,0	0,123
ABR 30	ABR030	30	54	58,6	15	M6 x 18	21,5	0,163
ABR 32	ABR032	32	54	58,6	15	M6 x 18	21,5	0,156
ABR 35	ABR035	35	57	61,6	15	M6 x 18	23,2	0,171
ABR 36	ABR036	36	57	61,6	15	M6 x 18	23,2	0,163
ABR 38	ABR038	38	60	65,0	15	M6 x 18	25,0	0,178
ABR 40	ABR040	40	60	65,0	15	M6 x 18	25,0	0,163
ABR 45	ABR045	45	73	79,4	19	M8 x 25	29,5	0,344
ABR 48	ABR048	48	78	84,2	19	M8 x 25	32,0	0,392
ABR 50	ABR050	50	78	84,2	19	M8 x 25	32,0	0,370
ABR 55	ABR055	55	82	88,8	19	M8 x 25	34,2	0,380
ABR 60	ABR060	60	88	94,0	19	M8 x 25	37,0	0,425
ABR 70	ABR070	70	98	104,5	19	M8 x 25	42,0	0,480
ABR 80	ABR080	80	108	113,8	19	M8 x 25	47,0	0,535



ANELLI A BLOCCAGGIO RADIALE A DUE SEZIONI - BRUNITI

SHAFT COLLARS TWO SPLIT - BLACK OXIDE

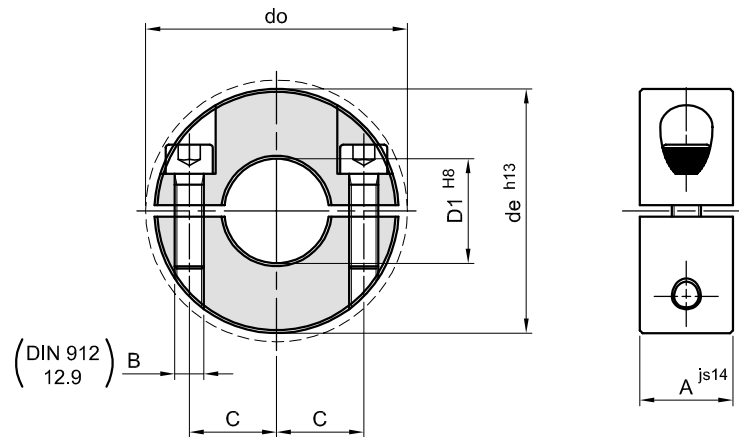

Materiale: Acciaio C-45

descrizione	codice	D1 mm	de mm	do mm	A mm	B mm	C mm	Kg.
ABRR 4	ABRR004	4	16	20,7	9	M3 x 8	5,5	0,011
ABRR 5	ABRR005	5	16	20,7	9	M3 x 8	5,5	0,011
ABRR 6	ABRR006	6	16	20,7	9	M3 x 8	5,5	0,010
ABRR 8	ABRR008	8	18	22,4	9	M3 x 8	6,5	0,012
ABRR 10	ABRR010	10	24	26,0	9	M3 x 8	8,5	0,024
ABRR 12	ABRR012	12	28	31,8	11	M4 x 12	10,0	0,039
ABRR 14	ABRR014	14	30	33,9	11	M4 x 12	11,0	0,043
ABRR 15	ABRR015	15	34	39,4	13	M5 x 14	12,5	0,068
ABRR 16	ABRR016	16	34	39,4	13	M5 x 14	12,5	0,065
ABRR 18	ABRR018	18	36	41,2	13	M5 x 14	13,5	0,071
ABRR 19	ABRR019	19	40	46,4	15	M6 x 16	14,7	0,104
ABRR 20	ABRR020	20	40	46,4	15	M6 x 16	14,7	0,101
ABRR 22	ABRR022	22	42	48,1	15	M6 x 16	16,0	0,107
ABRR 23	ABRR023	23	45	50,8	15	M6 x 16	17,5	0,127
ABRR 24	ABRR024	24	45	50,8	15	M6 x 16	17,5	0,122
ABRR 25	ABRR025	25	45	50,8	15	M6 x 16	17,5	0,120
ABRR 26	ABRR026	26	48	53,7	15	M6 x 18	19,0	0,139
ABRR 28	ABRR028	28	48	53,7	15	M6 x 18	19,0	0,128
ABRR 30	ABRR030	30	54	58,6	15	M6 x 18	21,5	0,171
ABRR 32	ABRR032	32	54	58,6	15	M6 x 18	21,5	0,161
ABRR 35	ABRR035	35	57	61,6	15	M6 x 18	23,2	0,172
ABRR 36	ABRR036	36	57	61,6	15	M6 x 18	23,2	0,169
ABRR 38	ABRR038	38	60	65,0	15	M6 x 18	25,0	0,183
ABRR 40	ABRR040	40	60	65,0	15	M6 x 18	25,0	0,172
ABRR 45	ABRR045	45	73	79,4	19	M8 x 25	29,5	0,360
ABRR 48	ABRR048	48	78	84,2	19	M8 x 25	32,0	0,414
ABRR 50	ABRR050	50	78	84,2	19	M8 x 25	32,0	0,386
ABRR 55	ABRR055	55	82	88,8	19	M8 x 25	34,2	0,395
ABRR 60	ABRR060	60	88	94,0	19	M8 x 25	37,0	0,440
ABRR 70	ABRR070	70	98	104,5	19	M8 x 25	42,0	0,495
ABRR 80	ABRR080	80	108	113,8	19	M8 x 25	47,0	0,550



ANELLI DI BLOCCAGGIO SECONDO DIN 705 - INOX

SHAFT COLLARS WITH SCREW DIN 705 - STAINLESS STEEL

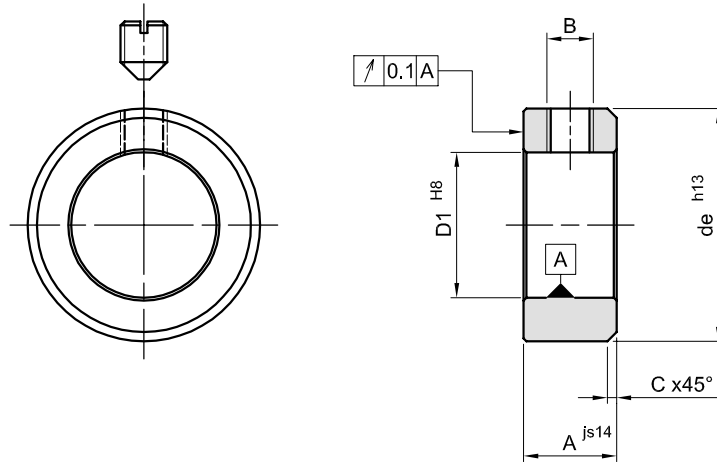

Con viti ad intaglio a punta conica - DIN 553 INOX
Slotted set screws with cone point - DIN 553 S.S.

Materiale: INOX AISI 304

descrizione	codice	tipo	D1 mm	de mm	A mm	B mm	C mm	Kg./100 pcs
AB 4	SSAB004	A	4	8	5	M2,5 x 3	0,5	0,15
AB 5	SSAB005	A	5	10	6	M3 x 4	0,6	0,28
AB 6	SSAB006	A	6	12	8	M4 x 5	0,8	0,54
AB 7	SSAB007	A	7	12	8	M4 x 5	0,8	0,48
AB 8	SSAB008	A	8	16	8	M4 x 6	0,8	0,94
AB 9	SSAB009	A	9	18	10	M5 x 8	1,0	1,51
AB 10	SSAB010	A	10	20	10	M5 x 8	1,0	1,85
AB 12	SSAB012	A	12	22	12	M6 x 8	1,2	2,52
AB 14	SSAB014	A	14	25	12	M6 x 8	1,2	3,17
AB 15	SSAB015	A	15	25	12	M6 x 8	1,2	2,98
AB 16	SSAB016	A	16	28	12	M6 x 8	1,2	3,84
AB 17	SSAB017	A	17	28	12	M6 x 8	1,2	4,00
AB 18	SSAB018	A	18	32	14	M6 x 8	1,4	6,00
AB 20	SSAB020	A	20	32	14	M6 x 8	1,4	5,30
AB 22	SSAB022	A	22	36	14	M6 x 10	1,4	6,90
AB 25	SSAB025	A	25	40	16	M8 x 10	1,6	9,56
AB 30	SSAB030	A	30	45	16	M8 x 10	1,6	11,10
AB 35	SSAB035	A	35	56	16	M8 x 12	1,6	18,70
AB 40	SSAB040	A	40	63	18	M10 x 16	1,8	26,10
AB 45	SSAB045	A	45	70	18	M10 x 16	1,8	31,70
AB 50	SSAB050	A	50	80	18	M10 x 16	1,8	42,90



ANELLI A BLOCCAGGIO RADIALE AD UNA SEZIONE - INOX

SHAFT COLLARS ONE SPLIT - STAINLESS STEEL

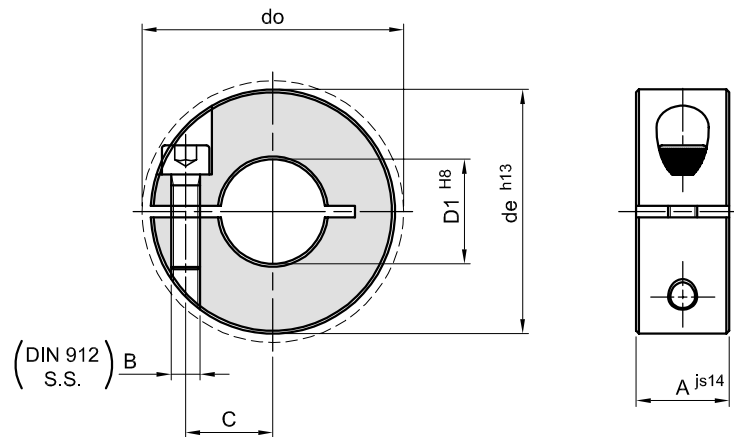

Materiale: INOX AISI 304

descrizione	codice	D1 mm	de mm	do mm	A mm	B mm	C mm	Kg.
ABR 4	SSABR004	4	16	20,7	9	M3 x 8	5,5	0,011
ABR 5	SSABR005	5	16	20,7	9	M3 x 8	5,5	0,010
ABR 6	SSABR006	6	16	20,7	9	M3 x 8	5,5	0,010
ABR 8	SSABR008	8	18	22,4	9	M3 x 8	6,5	0,012
ABR 10	SSABR010	10	24	26,0	9	M3 x 8	8,5	0,022
ABR 12	SSABR012	12	28	31,8	11	M4 x 12	10,0	0,038
ABR 14	SSABR014	14	30	33,9	11	M4 x 12	11,0	0,042
ABR 15	SSABR015	15	34	39,4	13	M5 x 14	12,5	0,065
ABR 16	SSABR016	16	34	39,4	13	M5 x 14	12,5	0,063
ABR 18	SSABR018	18	36	41,2	13	M5 x 14	13,5	0,069
ABR 19	SSABR019	19	40	46,4	15	M6 x 16	14,7	0,100
ABR 20	SSABR020	20	40	46,4	15	M6 x 16	14,7	0,097
ABR 22	SSABR022	22	42	48,1	15	M6 x 16	16,0	0,103
ABR 23	SSABR023	23	45	50,8	15	M6 x 16	17,5	0,122
ABR 24	SSABR024	24	45	50,8	15	M6 x 16	17,5	0,117
ABR 25	SSABR025	25	45	50,8	15	M6 x 16	17,5	0,114
ABR 26	SSABR026	26	48	53,7	15	M6 x 18	19,0	0,133
ABR 28	SSABR028	28	48	53,7	15	M6 x 18	19,0	0,123
ABR 30	SSABR030	30	54	58,6	15	M6 x 18	21,5	0,163
ABR 32	SSABR032	32	54	58,6	15	M6 x 18	21,5	0,156
ABR 35	SSABR035	35	57	61,6	15	M6 x 18	23,2	0,171
ABR 36	SSABR036	36	57	61,6	15	M6 x 18	23,2	0,163
ABR 38	SSABR038	38	60	65,0	15	M6 x 18	25,0	0,178
ABR 40	SSABR040	40	60	65,0	15	M6 x 18	25,0	0,163
ABR 45	SSABR045	45	73	79,4	19	M8 x 25	29,5	0,344
ABR 48	SSABR048	48	78	84,2	19	M8 x 25	32,0	0,392
ABR 50	SSABR050	50	78	84,2	19	M8 x 25	32,0	0,370
ABR 55	SSABR055	55	82	88,8	19	M8 x 25	34,2	0,380
ABR 60	SSABR060	60	88	94,0	19	M8 x 25	37,0	0,425
ABR 70	SSABR070	70	98	104,5	19	M8 x 25	42,0	0,480
ABR 80	SSABR080	80	108	113,8	19	M8 x 25	47,0	0,535



ANELLI A BLOCCAGGIO RADIALE A DUE SEZIONI - INOX

SHAFT COLLARS TWO SPLIT - STAINLESS STEEL

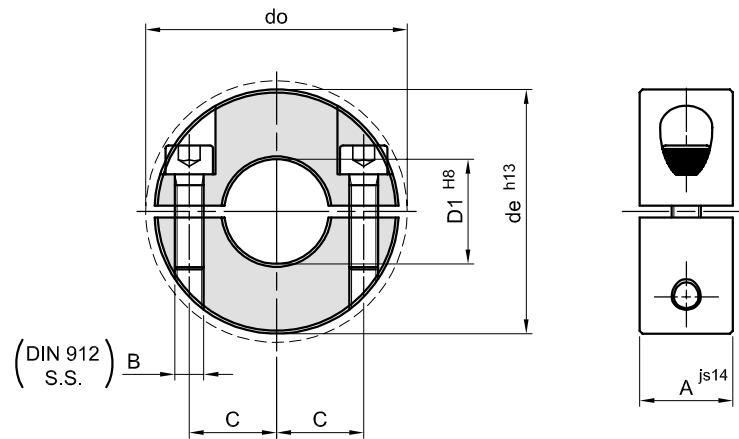

Materiale: INOX AISI 304

descrizione	codice	D1 mm	de mm	do mm	A mm	B mm	C mm	Kg.
ABRR 4	SSABRR004	4	16	20,7	9	M3 x 8	5,5	0,011
ABRR 5	SSABRR005	5	16	20,7	9	M3 x 8	5,5	0,011
ABRR 6	SSABRR006	6	16	20,7	9	M3 x 8	5,5	0,010
ABRR 8	SSABRR008	8	18	22,4	9	M3 x 8	6,5	0,012
ABRR 10	SSABRR010	10	24	26,0	9	M3 x 8	8,5	0,024
ABRR 12	SSABRR012	12	28	31,8	11	M4 x 12	10,0	0,039
ABRR 14	SSABRR014	14	30	33,9	11	M4 x 12	11,0	0,043
ABRR 15	SSABRR015	15	34	39,4	13	M5 x 14	12,5	0,068
ABRR 16	SSABRR016	16	34	39,4	13	M5 x 14	12,5	0,065
ABRR 18	SSABRR018	18	36	41,2	13	M5 x 14	13,5	0,071
ABRR 19	SSABRR019	19	40	46,4	15	M6 x 16	14,7	0,104
ABRR 20	SSABRR020	20	40	46,4	15	M6 x 16	14,7	0,101
ABRR 22	SSABRR022	22	42	48,1	15	M6 x 16	16,0	0,107
ABRR 23	SSABRR023	23	45	50,8	15	M6 x 16	17,5	0,127
ABRR 24	SSABRR024	24	45	50,8	15	M6 x 16	17,5	0,122
ABRR 25	SSABRR025	25	45	50,8	15	M6 x 16	17,5	0,120
ABRR 26	SSABRR026	26	48	53,7	15	M6 x 18	19,0	0,139
ABRR 28	SSABRR028	28	48	53,7	15	M6 x 18	19,0	0,128
ABRR 30	SSABRR030	30	54	58,6	15	M6 x 18	21,5	0,171
ABRR 32	SSABRR032	32	54	58,6	15	M6 x 18	21,5	0,161
ABRR 35	SSABRR035	35	57	61,6	15	M6 x 18	23,2	0,172
ABRR 36	SSABRR036	36	57	61,6	15	M6 x 18	23,2	0,169
ABRR 38	SSABRR038	38	60	65,0	15	M6 x 18	25,0	0,183
ABRR 40	SSABRR040	40	60	65,0	15	M6 x 18	25,0	0,172
ABRR 45	SSABRR045	45	73	79,4	19	M8 x 25	29,5	0,360
ABRR 48	SSABRR048	48	78	84,2	19	M8 x 25	32,0	0,414
ABRR 50	SSABRR050	50	78	84,2	19	M8 x 25	32,0	0,386
ABRR 55	SSABRR055	55	82	88,8	19	M8 x 25	34,2	0,395
ABRR 60	SSABRR060	60	88	94,0	19	M8 x 25	37,0	0,440
ABRR 70	SSABRR070	70	98	104,5	19	M8 x 25	42,0	0,495
ABRR 80	SSABRR080	80	108	113,8	19	M8 x 25	47,0	0,550





TESTE A SNODO DIN 648 - LUBRIFICABILI

ROD ENDS DIN 648 - WITH LUBRICATION

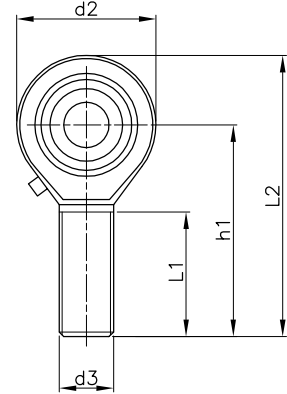
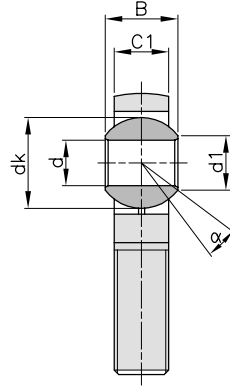

Materiale:

- Gambo: acciaio zincato
- Inserto: bronzo autolubrificante
- Anello interno: acciaio temprato, rettificato e lappato

descrizione	codice		d	d3	B	C1	L1	d2	L2	h1	d1	dk	α°	carico		Kg.
	filettatura destra	filettatura sinistra												din. C KN	st. C ₀ KN	
B-JAM 5	BJAM05R	BJAM05L	5	M5 x 0,8	8	6,0	20	18	42	33	7,7	11,1	13	3,3	3,1	0,013
B-JAM 6	BJAM06R	BJAM06L	6	M6 x 1	9	6,8	23	20	46	36	8,9	12,7	13	4,3	4,4	0,020
B-JAM 8	BJAM08R	BJAM08L	8	M8 x 1,25	12	9,0	25	24	54	42	10,3	15,9	14	7,2	8,0	0,030
B-JAM 10	BJAM10R	BJAM10L	10	M10 x 1,5	14	10,5	30	26	61	48	12,9	19,1	13	10,0	12,9	0,055
B-JAM 12	BJAM12R	BJAM12L	12	M12 x 1,75	16	12,0	34	30	69	54	15,4	22,2	13	13,4	17,0	0,085
B-JAM 14	BJAM14R	BJAM14L	14	M14 x 2	19	13,5	37	34	77	60	16,8	25,4	16	17,0	24,0	0,140
B-JAM 16	BJAM16R	BJAM16L	16	M16 x 2	21	15,0	41	40	86	66	19,3	28,6	15	21,6	28,5	0,210
B-JAM 18	BJAM18R	BJAM18L	18	M18 x 1,5	23	16,5	41	44	94	72	21,8	31,8	15	26,0	42,5	0,280
B-JAM 20	BJAM20R	BJAM20L	20	M20 x 1,5	25	18,0	45	48	102	78	24,3	34,9	14	31,5	42,5	0,380
B-JAM 22	BJAM22R	BJAM22L	22	M22 x 1,5	28	20,0	48	54	111	84	25,8	38,1	15	38,0	57,0	0,480
B-JAM 25	BJAM25R	BJAM25L	25	M24 x 2	31	22,0	55	60	124	94	29,5	42,9	15	47,5	68,0	0,640
B-JAM 28	BJAM28R	BJAM28L	28	M27 x 2	35	24,0	62	66	136	103	33,7	47,6	15	55,0	75,5	0,960
B-JAM 30	BJAM30R	BJAM30L	30	M30 x 2	37	25,0	66	70	145	110	34,8	50,8	17	64,0	88,0	1,100



TESTE A SNODO DIN 648 - LUBRIFICABILI

ROD ENDS DIN 648 - WITH LUBRICATION

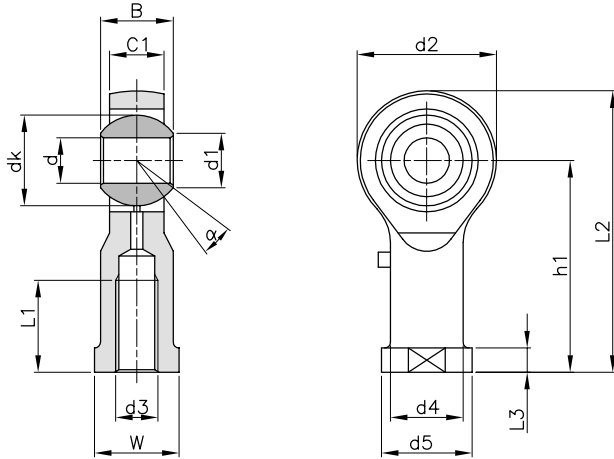

Materiale:

- Gambo: acciaio zincato
- Inserto: bronzo autolubrificante
- Anello interno: acciaio temprato, rettificato e lappato

descrizione	codice		d	d3	B	C1	L1	d2	L2	h1	L3	d4	d5	W	d1	dk	α°	carico		Kg.
	filettatura destra	filettatura sinistra																din. C KN	st. Co. KN	
B-JAF 5	BJAF05R	BJAF05L	5	M5 x 0,8	8	6,0	14	18	36	27	4,0	8,5	12	9	7,7	11,1	13	3,3	5,7	0,016
B-JAF 6	BJAF06R	BJAF06L	6	M6 x 1	9	6,8	14	20	40	30	5,0	10,0	13	11	8,9	12,7	13	4,3	7,2	0,022
B-JAF 8	BJAF08R	BJAF08L	8	M8 x 1,25	12	9,0	17	24	48	36	5,0	12,5	16	14	10,3	15,9	14	7,2	11,6	0,047
B-JAF 10	BJAF10R	BJAF10L	10	M10 x 1,5	14	10,5	21	26	56	43	6,5	15,0	19	17	12,9	19,1	13	10,0	14,5	0,077
B-JAF 12	BJAF12R	BJAF12L	12	M12 x 1,75	16	12,0	24	30	65	50	6,5	17,5	22	19	15,4	22,2	13	13,4	17,0	0,100
B-JAF 14	BJAF14R	BJAF14L	14	M14 x 2	19	13,5	27	34	74	57	8,0	20,0	26	22	16,8	25,4	16	17,0	24,0	0,160
B-JAF 16	BJAF16R	BJAF16L	16	M16 x 2	21	15,0	33	40	84	64	8,0	22,0	28	24	19,3	28,6	15	21,6	28,5	0,220
B-JAF 18	BJAF18R	BJAF18L	18	M18 x 1,5	23	16,5	36	44	93	71	10,0	25,0	31	27	21,8	31,7	15	26,0	42,5	0,320
B-JAF 20	BJAF20R	BJAF20L	20	M20 x 1,5	25	18,0	40	48	101	77	10,0	27,5	35	30	24,3	35,0	14	31,5	42,5	0,420
B-JAF 22	BJAF22R	BJAF22L	22	M22 x 1,5	28	20,0	43	54	111	84	12,0	30,0	38	32	25,8	38,1	15	38,0	57,0	0,540
B-JAF 25	BJAF25R	BJAF25L	25	M24 x 2	31	22,0	48	60	124	94	12,0	33,5	42	36	29,5	42,9	15	47,5	68,0	0,720
B-JAF 28	BJAF28R	BJAF28L	28	M27 x 2	35	24,0	53	66	136	103	14,0	37,0	46	41	33,7	47,6	15	55,0	75,0	0,820
B-JAF 30	BJAF30R	BJAF30L	30	M30 x 2	37	25,0	56	70	145	110	15,0	40,0	50	46	34,8	50,8	17	64,0	88,0	1,100



SUPPORTI PER CUSCINETTI IN LAMIERA - ZINCATI BALL FLANGE BEARING IN STEEL - ZINC PLATED

SUPPORTI IN LAMIERA "B-SBPF"

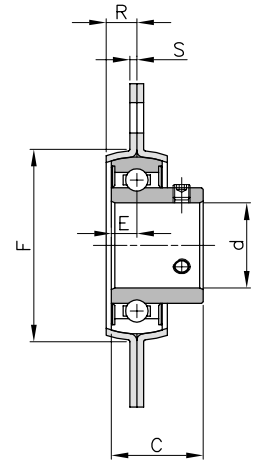
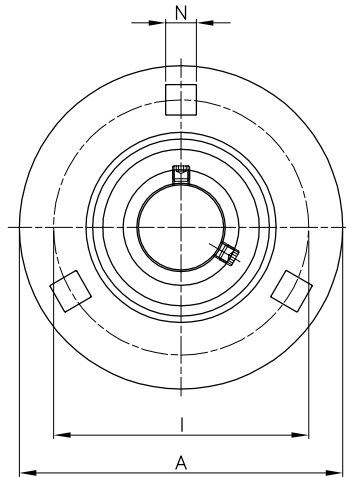

descrizione	codice	d mm	dimensioni (mm)								Kg.
			A	I	F	R	N	S	C	E	
B-SBPF201	BSBPF201	12	81	63,5	49	7	7	2	22	6	0,27
B-SBPF202	BSBPF202	15	81	63,5	49	7	7	2	22	6	0,27
B-SBPF203	BSBPF203	17	81	63,5	49	7	7	2	22	6	0,27
B-SBPF204	BSBPF204	20	90	71,5	56	8	8	2	25	7	0,33
B-SBPF205	BSBPF205	25	95	76	60	9	9	2	27	7,5	0,38
B-SBPF206	BSBPF206	30	113	90,5	71	9,5	10	2,6	30	8	0,62
B-SBPF207	BSBPF207	35	123	100	81	11	10,5	2,6	32	8,5	0,82
B-SBPF208	BSBPF208	40	148	119	90	11	13,5	3,4	34	9	1,10

SUPPORTI IN LAMIERA "B-SBPDF"

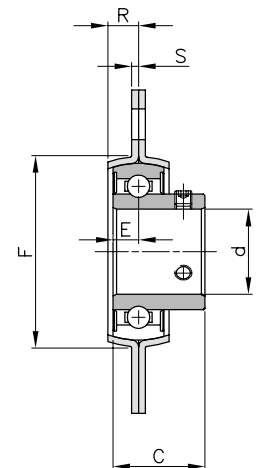
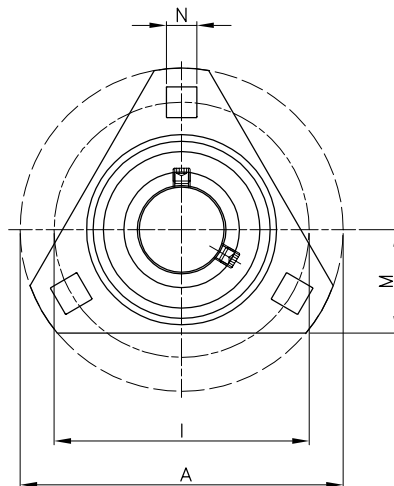

descrizione	codice	d mm	dimensioni (mm)								Kg.	
			A	I	M	F	R	N	S	C		E
B-SBPDF201	BSBPDF201	12	81	63,5	29	49	7	7,1	2	22	6	0,23
B-SBPDF202	BSBPDF202	15	81	63,5	29	49	7	7,1	2	22	6	0,23
B-SBPDF203	BSBPDF203	17	81	63,5	29	49	7	7,1	2	22	6	0,23
B-SBPDF204	BSBPDF204	20	90	71,5	33	56	8	9	2	25	7	0,28
B-SBPDF205	BSBPDF205	25	95	76	35	60	9	9	2	27	7,5	0,36
B-SBPDF206	BSBPDF206	30	113	90,5	38	71	9,5	11	2,6	30	8	0,55
B-SBPDF207	BSBPDF207	35	122	100	45	81	11	11	2,6	32	8,5	0,74



SUPPORTI PER CUSCINETTI IN LAMIERA - ZINCATI BALL FLANGE BEARING IN STEEL - ZINC PLATED

SUPPORTI IN LAMIERA "B-SBPFL"

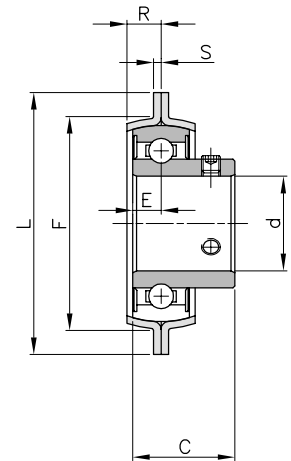
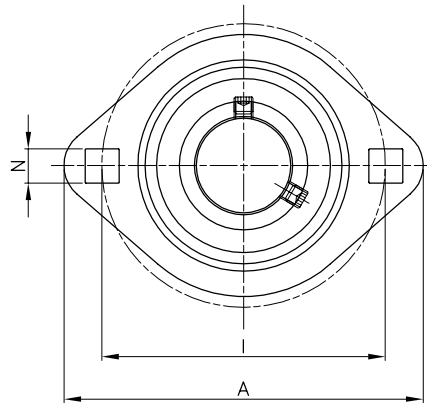

descrizione	codice	d mm	dimensioni (mm)									Kg.
			A	I	L	F	R	N	S	C	E	
B-SBPFL201	BSBPFL201	12	81	63,5	59	49	7	7,1	2	22	6	0,23
B-SBPFL202	BSBPFL202	15	81	63,5	59	49	7	7,1	2	22	6	0,23
B-SBPFL203	BSBPFL203	17	81	63,5	59	49	7	7,1	2	22	6	0,23
B-SBPFL204	BSBPFL204	20	91	71,5	67	56	8	8,7	2	25	7	0,28
B-SBPFL205	BSBPFL205	25	96	76	71	60	9	8,7	2	27	7,5	0,28
B-SBPFL206	BSBPFL206	30	113	90,5	84	71	9,5	11	2,6	30	8	0,38
B-SBPFL207	BSBPFL207	35	123	100	94	81	11	11	2,6	32	8,5	0,54
B-SBPFL208	BSBPFL208	40	148	119	100	90	11	13,5	6,8	34	9	0,80

SUPPORTI IN LAMIERA "B-SBPP"

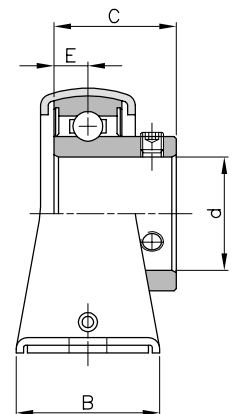
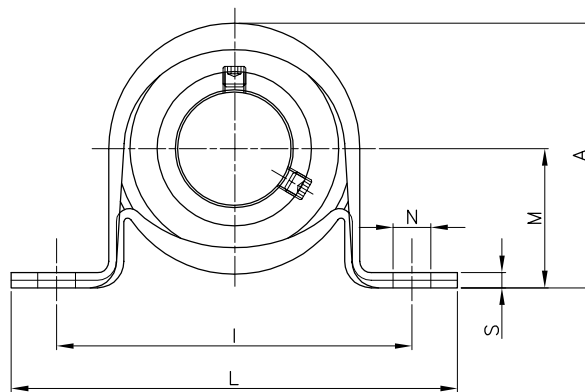

descrizione	codice	d mm	dimensioni (mm)									Kg.
			L	I	A	B	M	N	S	C	E	
B-SBPP201	BSBPP201	12	86	68	43,8	25	22,2	9,5	3,2	22	6	0,16
B-SBPP202	BSBPP202	15	86	68	43,8	25	22,2	9,5	3,2	22	6	0,16
B-SBPP203	BSBPP203	17	86	68	43,8	25	22,2	9,5	3,2	22	6	0,16
B-SBPP204	BSBPP204	20	98	76	50,5	32	25,4	9,5	3,2	25	7	0,23
B-SBPP205	BSBPP205	25	108	86	56,6	32	28,6	11,5	4	27	7,5	0,28
B-SBPP206	BSBPP206	30	118	95	66,3	38	33,3	11,5	4	30	8	0,47
B-SBPP207	BSBPP207	35	129	106	78	42	39,7	11,5	4,6	32	8,5	0,57



SUPPORTI PER CUSCINETTI IN GHISA BALL FLANGE BEARING IN CAST IRON

SUPPORTI IN GHISA "B-UCFA"

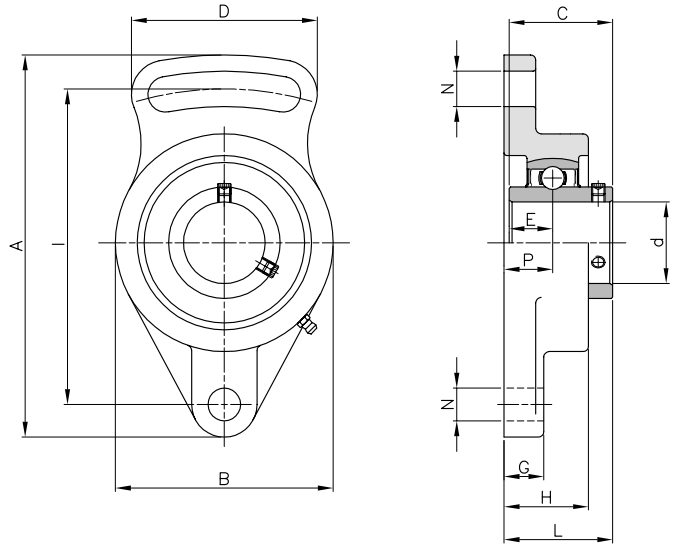

descrizione	codice	d mm	dimensioni (mm)											Kg.
			A	I	P	G	H	N	B	L	D	C	E	
B-UCFA204	BUCFA204	20	98	78	15	12	25,5	10	60	33,3	50	31	12,7	0,46
B-UCFA205	BUCFA205	25	124	98	16	14	27	13	70	36,8	65	34,1	14,3	0,66
B-UCFA206	BUCFA206	30	141	115	18	14	31	13	83	40,2	72	38,1	15,9	0,93
B-UCFA207	BUCFA207	35	155	128	19	16	34	15	96	44,4	82	42,9	17,5	1,46
B-UCFA208	BUCFA208	40	171	142	21	16	38	15	105	51,2	87	49,2	19	1,78
B-UCFA209	BUCFA209	45	179	146	22	18	40	17	111	52,2	90	49,2	19	2,03
B-UCFA210	BUCFA210	50	189	155	22	18	40	17	116	54,6	94	51,6	19	2,23

SUPPORTI IN GHISA "B-UCFB"

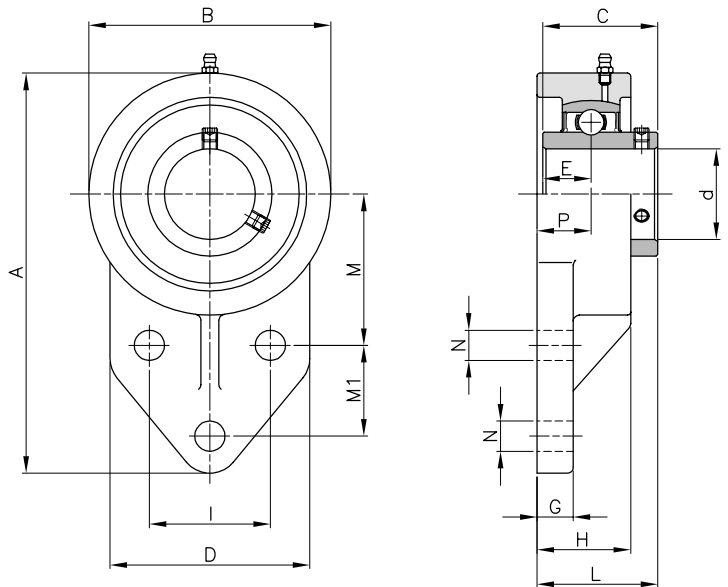
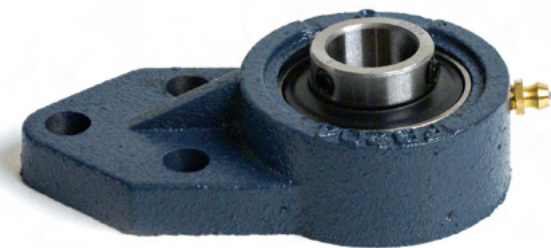

descrizione	codice	d mm	dimensioni (mm)											Kg.		
			A	B	D	H	N	G	M	M1	I	P	L		C	E
B-UCFB204	BUCFB204	20	110	62	52	25,5	10	13	42	27	32	15	33,3	31	12,7	0,54
B-UCFB205	BUCFB205	25	116	68	56	27	10	13	45	27	34	16	35,8	34,1	14,3	0,79
B-UCFB206	BUCFB206	30	130	78	65	31	10	13	50	29	40	18	40,2	38,1	15,9	0,95
B-UCFB207	BUCFB207	35	144	90	70	34	10	15	55	32	46	19	44,4	42,9	17,5	1,29
B-UCFB208	BUCFB208	40	164	100	78	36	12	16	60	41	50	21	51,2	49,2	19	1,78
B-UCFB209	BUCFB209	45	174	106	80	38	12	18	65	43	54	22	52,2	49,2	19	1,91
B-UCFB210	BUCFB210	50	184	112	86	40	12	18	68	46	58	22	54,6	51,6	19	2,36



SUPPORTI PER CUSCINETTI IN GHISA BALL FLANGE BEARING IN CAST IRON

SUPPORTI IN GHISA "B-UCFC"

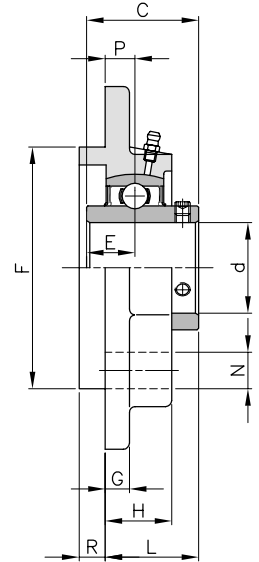
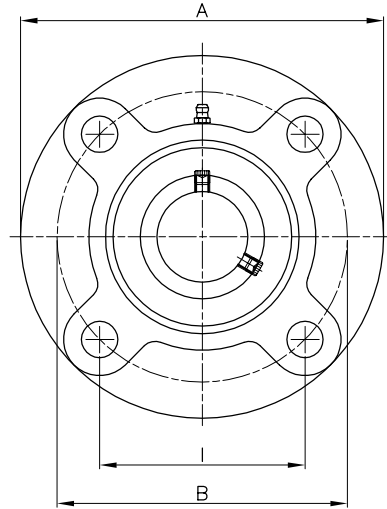

descrizione	codice	d mm	dimensioni (mm)												Kg.
			A	B	I	P	N	R	G	H	F	L	C	E	
B-UCFC204	BUCFC204	20	100	78	55,1	10	12	5	7	20,5	62	28,3	31	12,7	0,69
B-UCFC205	BUCFC205	25	115	90	63,6	10	12	6	7	21	70	29,8	34,1	14,3	1,00
B-UCFC206	BUCFC206	30	125	100	70,7	10	12	8	8	23	80	32,2	38,1	15,9	1,30
B-UCFC207	BUCFC207	35	136	110	77,8	11	14	8	9	26	90	36,4	42,9	17,5	1,81
B-UCFC208	BUCFC208	40	145	120	84,8	11	14	10	9	26	100	41,2	49,2	19	2,14
B-UCFC209	BUCFC209	45	160	132	93,3	12	16	12	14	26	105	40,2	49,2	19	2,68
B-UCFC210	BUCFC210	50	165	138	97,6	12	16	12	14	28	110	42,6	51,6	19	2,90
B-UCFC211	BUCFC211	55	185	150	106,1	13	19	12	15	31	125	46,4	55,6	22,2	4,01
B-UCFC212	BUCFC212	60	195	160	113,1	15	19	12	15	36	135	56,7	65,1	25,4	4,94
B-UCFC213	BUCFC213	65	205	170	120,2	16	19	14	15	36	145	55,7	65,1	25,4	5,65
B-UCFC214	BUCFC214	70	215	177	125,1	17	19	14	18	40	150	61,4	74,6	30,2	6,95
B-UCFC215	BUCFC215	75	220	184	130,1	18	19	16	18	40	160	62,5	77,8	30,3	7,56
B-UCFC216	BUCFC216	80	240	200	141	18	23	16	18	42	170	67,3	82,6	33,3	9,15



SUPPORTI PER CUSCINETTI IN GHISA BALL FLANGE BEARING IN CAST IRON

SUPPORTI IN GHISA "B-UCF"

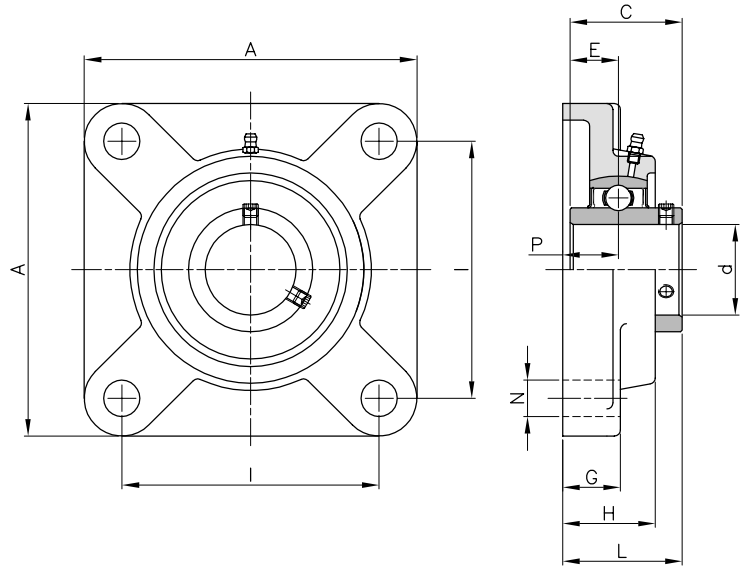

descrizione	codice	d mm	dimensioni (mm)									Kg.
			A	I	P	G	H	N	L	C	E	
B-UCF202	BUCF202	15	86	64	15	12	25,5	12	33,3	31	12,7	0,55
B-UCF203	BUCF203	17	86	64	15	12	25,5	12	33,3	31	12,7	0,56
B-UCF204	BUCF204	20	86	64	15	12	25,5	12	33,3	31	12,7	0,57
B-UCF205	BUCF205	25	95	70	16	13	27	12	35,7	34	14,3	0,83
B-UCF206	BUCF206	30	108	83	18	13	31	12	40,2	38,1	15,9	1,10
B-UCF207	BUCF207	35	117	92	19	15	34	14	44,4	42,9	17,5	1,50
B-UCF208	BUCF208	40	130	102	21	15	36	16	51,2	49,2	19	1,90
B-UCF209	BUCF209	45	137	105	22	16	38	16	52,2	49,2	19	2,20
B-UCF210	BUCF210	50	143	111	22	16	40	16	54,6	51,6	22,2	2,50
B-UCF211	BUCF211	55	162	130	25	18	43	19	58,4	55,6	25,4	3,40
B-UCF212	BUCF212	60	175	143	29	22	48	19	68,7	65,1	25,4	4,20
B-UCF213	BUCF213	65	187	149	30	22	50	19	69,7	65,1	30,2	5,20
B-UCF214	BUCF214	70	193	152	31	22	54	19	75,4	74,6	33,3	5,90
B-UCF215	BUCF215	75	200	159	34	22	56	19	78,5	77,8	33,3	6,40
B-UCF216	BUCF216	80	208	165	34	22	58	23	83,3	82,6	33,3	7,30
B-UCF217	BUCF217	85	220	175	36	24	63	23	87,6	85,7	34,1	8,90



SUPPORTI PER CUSCINETTI IN GHISA BALL FLANGE BEARING IN CAST IRON

SUPPORTI IN GHISA "B-UCFL"

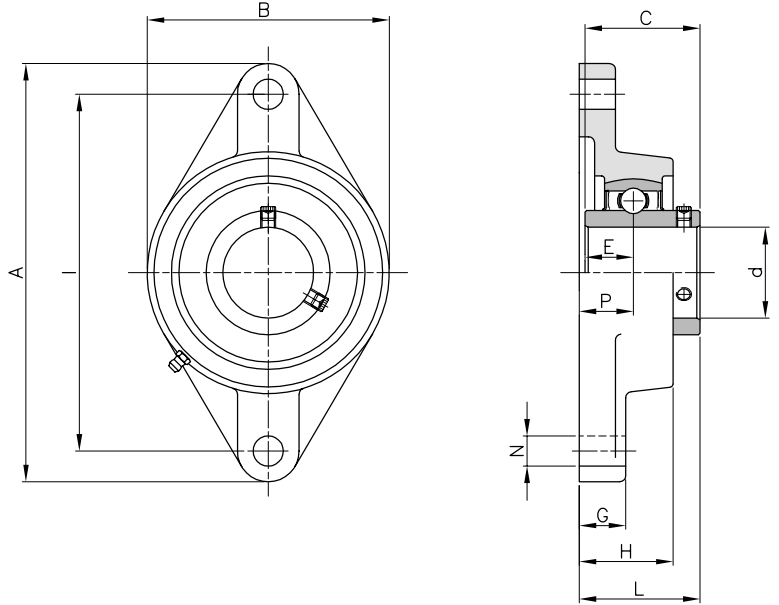

descrizione	codice	d mm	dimensioni (mm)										Kg.
			A	I	P	G	H	N	B	L	C	E	
B-UCFL202	BUCFL202	15	113	90	15	11	25,5	12	60	33,3	31	12,7	0,44
B-UCFL203	BUCFL203	17	113	90	15	11	25,5	12	60	33,3	31	12,7	0,43
B-UCFL204	BUCFL204	20	113	90	15	11	25,5	12	60	33,3	31	12,7	0,43
B-UCFL205	BUCFL205	25	130	99	16	13	27	16	68	35,8	34,1	14,3	0,58
B-UCFL206	BUCFL206	30	148	117	18	13	31	16	80	40,2	38,1	15,9	0,86
B-UCFL207	BUCFL207	35	161	130	19	14	34	16	90	44,4	42,9	17,5	1,08
B-UCFL208	BUCFL208	40	175	144	21	14	36	16	100	51,2	49,2	19	1,44
B-UCFL209	BUCFL209	45	188	148	22	15	38	19	108	52,2	49,2	19	1,74
B-UCFL210	BUCFL210	50	197	157	22	15	40	19	115	54,6	51,6	19	2,10
B-UCFL211	BUCFL211	55	224	184	25	18	43	19	130	58,4	55,6	22,2	2,91
B-UCFL212	BUCFL212	60	250	202	29	18	48	23	140	68,7	65,1	25,4	3,74
B-UCFL213	BUCFL213	65	258	210	30	22	50	23	155	69,7	65,1	25,4	4,57
B-UCFL214	BUCFL214	70	265	216	31	22	54	23	160	75,4	74,6	30,2	5,11



SUPPORTI PER CUSCINETTI IN GHISA BALL PILLOW BLOCK BEARING IN CAST IRON

SUPPORTI IN GHISA "B-UCHA"

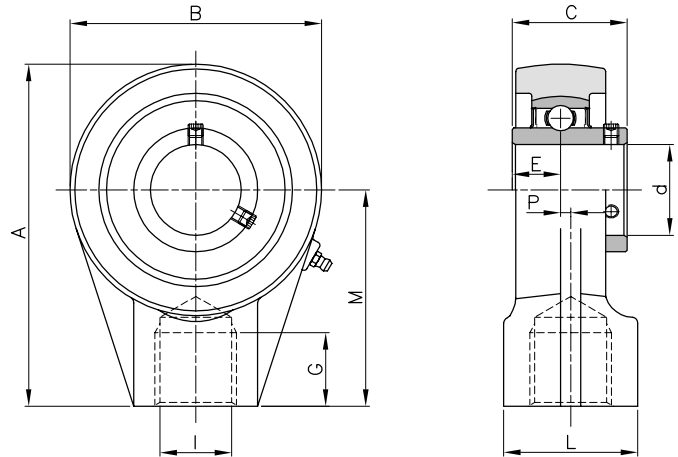

descrizione	codice	d mm	dimensioni (mm)									Kg.
			B	A	P	M	L	G	I	C	E	
B-UCHA204	BUCHA204	20	64	96		64	40	19	3/4"	31	12,7	0,73
B-UCHA205	BUCHA205	25	78	103		64	40	19	3/4"	34,1	14,3	0,83
B-UCHA206	BUCHA206	30	78	103		64	40	19	3/4"	38,1	15,9	0,83
B-UCHA207	BUCHA207	35	92	116		70	40	19	3/4"	42,9	17,5	1,16
B-UCHA208	BUCHA208	40	96	121	2	73	40	19	3/4"	49,2	19	1,32
B-UCHA209	BUCHA209	45	108	136	5	82	48	21	1"	49,2	19	1,72
B-UCHA210	BUCHA210	50	118	142	5	83	48	21	1"	51,6	19	1,90

SUPPORTI IN GHISA "B-UCPA"

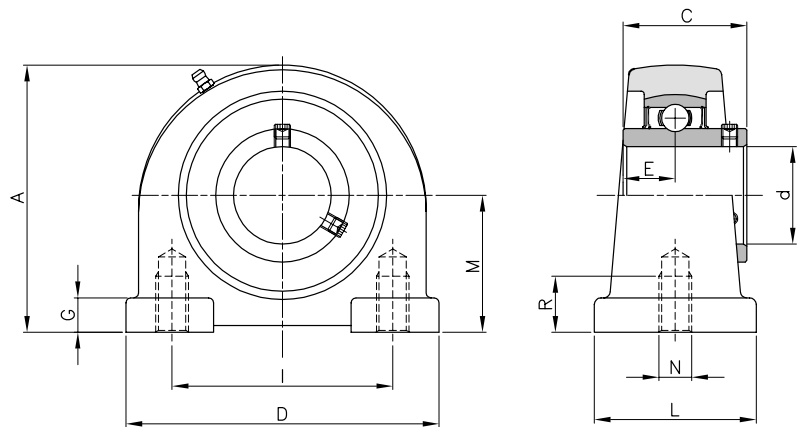
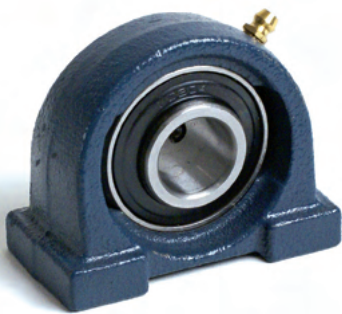

descrizione	codice	d mm	dimensioni (mm)										Kg.
			M	D	I	L	N	G	A	R	C	E	
B-UCPA204	BUCPA204	20	30,2	76	52	40	M10	11	62	13	31	12,7	0,60
B-UCPA205	BUCPA205	25	36,5	84	56	38	M10	12	72	13	34,1	14,3	0,83
B-UCPA206	BUCPA206	30	42,9	94	66	50	M14	12	84	18	38,1	15,9	1,12
B-UCPA207	BUCPA207	35	47,6	110	80	55	M14	13	95	20	42,9	17,5	1,48
B-UCPA208	BUCPA208	40	49,2	116	84	58	M14	13	100	20	49,2	19	1,89
B-UCPA209	BUCPA209	45	54,2	120	90	60	M14	13	108	25	49,2	19	1,98
B-UCPA210	BUCPA210	50	57,2	130	94	64	M16	14	116	25	51,6	19	2,16



SUPPORTI PER CUSCINETTI IN GHISA

BALL PILLOW BLOCK BEARING IN CAST IRON

SUPPORTI IN GHISA "B-UCP"

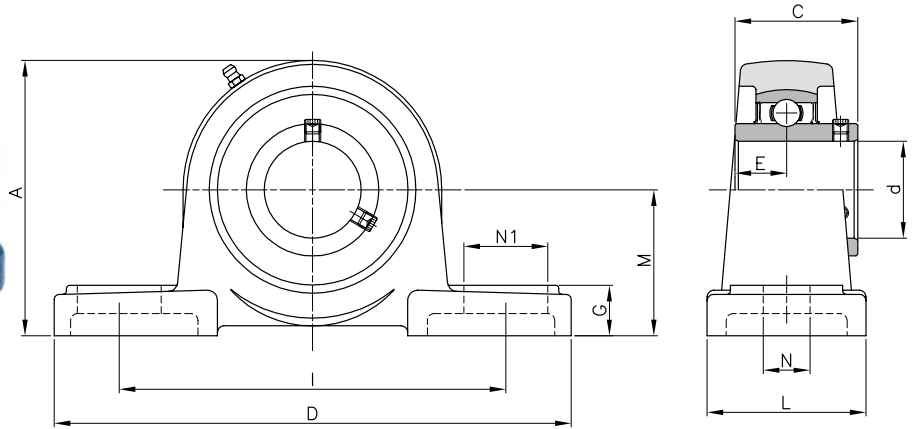
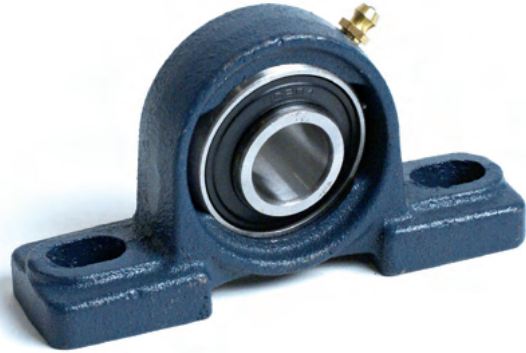

descrizione	codice	d mm	dimensioni (mm)										Kg.
			M	D	I	L	N1	N	G	A	C	E	
B-UCP201	BUCP201	12	33,3	127	95	38	19	13	14	65	31	12,7	0,69
B-UCP202	BUCP202	15	33,3	127	95	38	19	13	14	65	31	12,7	0,67
B-UCP203	BUCP203	17	33,3	127	95	38	19	13	14	65	31	12,7	0,67
B-UCP204	BUCP204	20	33,3	127	95	38	19	13	14	65	31	12,7	0,66
B-UCP205	BUCP205	25	36,5	140	105	38	19	13	15	71	34,1	14,3	0,81
B-UCP206	BUCP206	30	42,9	165	121	46	20	17	17	84	36,1	15,9	1,24
B-UCP207	BUCP207	35	47,6	167	127	48	20	17	18	93	42,9	17,5	1,58
B-UCP208	BUCP208	40	49,2	184	137	54	20	17	18	100	49,2	19	1,89
B-UCP209	BUCP209	45	54	190	146	54	20	17	20	106	49,2	19	2,14
B-UCP210	BUCP210	50	57,2	206	159	60	23	20	21	113	51,6	19	2,66
B-UCP211	BUCP211	55	63,5	219	171	60	23	20	23	125	55,6	22,2	3,31
B-UCP212	BUCP212	60	69,8	241	184	70	23	20	25	138	65,1	25,4	4,00
B-UCP213	BUCP213	65	76,2	265	203	70	28	25	27	150	65,1	25,4	5,15
B-UCP214	BUCP214	70	79,4	266	210	72	28	25	27	156	74,6	30,2	6,20
B-UCP215	BUCP215	75	82,6	275	217	74	28	25	28	162	77,8	33,3	7,16
B-UCP216	BUCP216	80	88,9	292	232	78	28	25	30	174	82,6	33,3	8,10



SUPPORTI PER CUSCINETTI IN GHISA BALL PILLOW BLOCK BEARING IN CAST IRON

SUPPORTI IN GHISA "B-UCT"

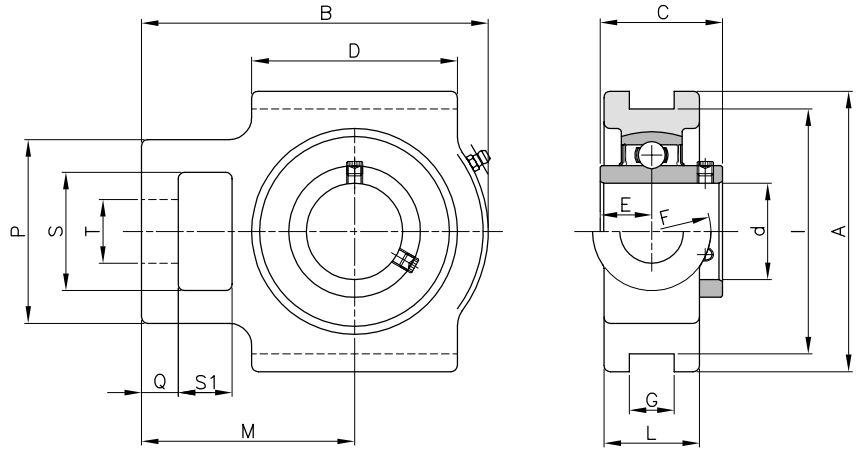

descrizione	codice	d mm	dimensioni (mm)															Kg.
			S1	Q	S	F	P	T	D	G	I	A	B	L	M	C	E	
B-UCT204	BUCT204	20	16	10	32	32	51	19	51	12	76	89	94	24	61	31	12,7	0,76
B-UCT205	BUCT205	25	16	10	32	32	51	19	51	12	76	89	97	24	62	34,1	14,3	0,81
B-UCT206	BUCT206	30	16	10	37	37	56	22	57	12	89	102	113	28	70	38,1	15,9	1,22
B-UCT207	BUCT207	35	16	13	37	37	64	22	64	12	89	102	129	30	78	42,9	17,5	1,44
B-UCT208	BUCT208	40	19	16	49	49	83	29	83	16	102	114	144	35	83	49,2	19	2,40
B-UCT209	BUCT209	45	19	16	49	49	83	29	83	16	102	117	144	35	87	49,2	19	2,36
B-UCT210	BUCT210	50	19	16	49	49	83	29	86	16	102	117	149	35	90	51,6	19	2,43
B-UCT211	BUCT211	55	25	19	64	64	102	35	95	22	130	146	171	38	106	55,6	22,2	4,11
B-UCT212	BUCT212	60	32	19	64	64	102	35	102	22	130	146	194	42	119	65,1	25,4	4,97
B-UCT213	BUCT213	65	32	21	70	70	111	41	121	26	151	167	224	44	137	65,1	25,4	6,65
B-UCT214	BUCT214	70	32	21	70	70	111	41	121	26	151	167	224	46	137	74,6	30,2	7,05
B-UCT215	BUCT215	75	32	21	70	70	111	41	121	26	151	167	232	48	140	77,8	33,3	7,41



SUPPORTI PER CUSCINETTI IN ACCIAIO INOX BALL FLANGE BEARING IN STAINLESS STEEL

SUPPORTI IN ACCIAIO INOX "B-UCF"

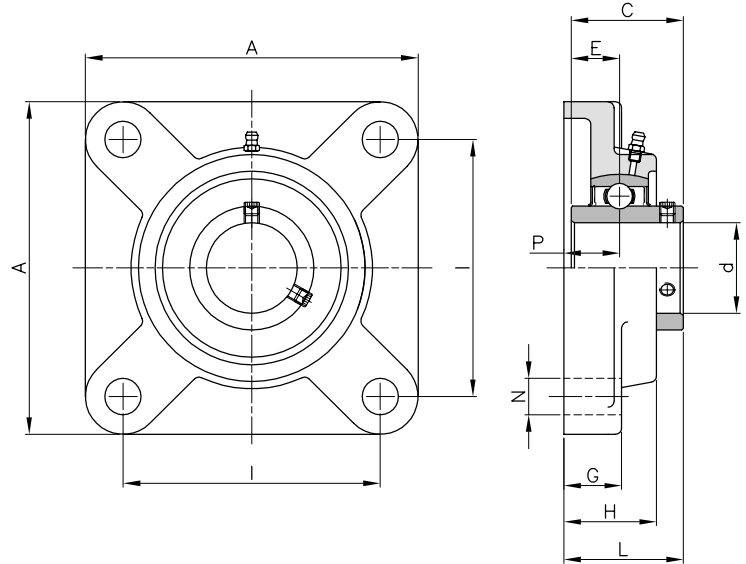
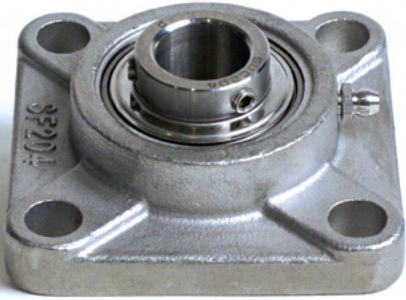

Materiale:
- Supporto: INOX AISI 304
- Cuscinetto: INOX AISI 440

descrizione	codice	d mm	dimensioni (mm)									cuscinetto		Kg.	
			A	I	P	G	H	N	L	C	E	codice	carico KN dinamo C statico C ₀		
B-UCF201	SSBUCF201	12	86	64	15	12	25,5	12	33,3	31	12,7	SSBUC201	9880	6200	0,64
◇ B-UCF202	SSBUCF202	15	86	64	15	12	25,5	12	33,3	31	12,7	SSBUC202	9880	6200	0,63
B-UCF203	SSBUCF203	17	86	64	15	12	25,5	12	33,3	31	12,7	SSBUC203	9880	6200	0,61
B-UCF204	SSBUCF204	20	86	64	15	12	25,5	12	33,3	31	12,7	SSBUC204	9880	6200	0,59
B-UCF205	SSBUCF205	25	95	70	16	14	27	12	35,7	34	14,3	SSBUC205	10780	6980	0,82
B-UCF206	SSBUCF206	30	108	83	18	14	31	12	40,2	38,1	15,9	SSBUC206	14970	10040	1,10
B-UCF207	SSBUCF207	35	117	92	19	16	34	14	44,4	42,9	17,5	SSBUC207	19750	13670	1,50
B-UCF208	SSBUCF208	40	130	102	21	16	36	16	51,2	49,2	19	SSBUC208	22710	15940	1,90
B-UCF209	SSBUCF209	45	137	105	22	18	38	16	52,2	49,2	19	SSBUC209	24360	17710	2,30
B-UCF210	SSBUCF210	50	143	111	22	18	40	16	54,6	51,6	19	SSBUC210	26980	19840	2,50



SUPPORTI PER CUSCINETTI IN ACCIAIO INOX BALL FLANGE BEARING IN STAINLESS STEEL

SUPPORTI IN ACCIAIO INOX "B-UCFL"

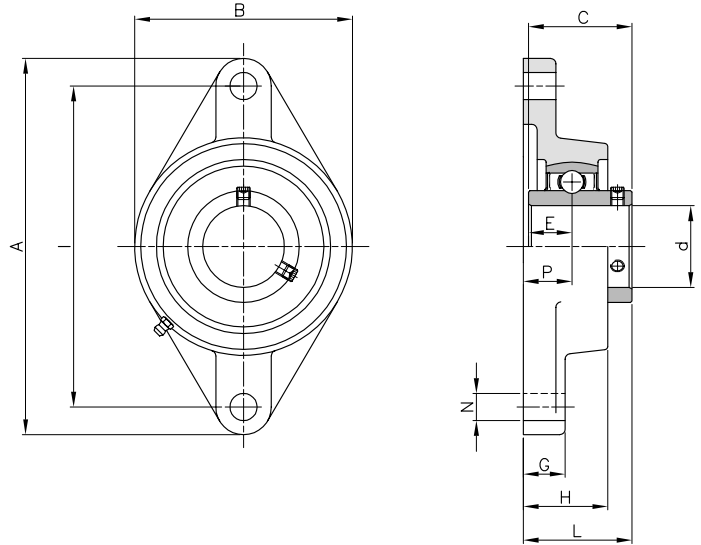

Materiale:

- Supporto: INOX AISI 304
- Cuscinetto: INOX AISI 440

descrizione	codice	d mm	dimensioni (mm)										cuscinetto		Kg.
			A	I	G	P	H	N	B	L	C	E	codice	carico KN dinamo C statico C ₀	
B-UCFL204	SSBUCFL204	20	113	90	10	15	25,5	12	60	33,3	31	12,7	SSBUC204	9880 6200	0,49
B-UCFL205	SSBUCFL205	25	130	99	10	16	27	16	68	35,7	34	14,3	SSBUC205	10780 6980	0,63
B-UCFL206	SSBUCFL206	30	148	117	10	18	31	16	80	40,2	38,1	15,9	SSBUC206	14970 10040	0,94
B-UCFL207	SSBUCFL207	35	161	130	11	19	34	16	90	44,4	42,9	17,5	SSBUC207	19750 13670	1,20
B-UCFL208	SSBUCFL208	40	175	144	11	21	36	16	100	51,2	49,2	19	SSBUC208	22710 15940	1,60
B-UCFL209	SSBUCFL209	45	188	148	13	22	38	19	108	52,2	49,2	19	SSBUC209	24360 17710	1,90
B-UCFL210	SSBUCFL210	50	197	157	13	22	40	19	115	54,6	51,6	19	SSBUC210	26980 19840	2,20

SUPPORTI IN ACCIAIO INOX "B-UCP"

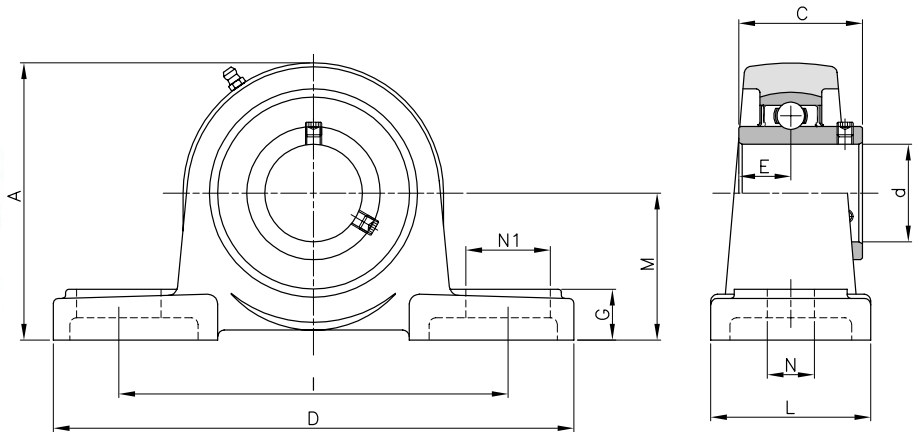
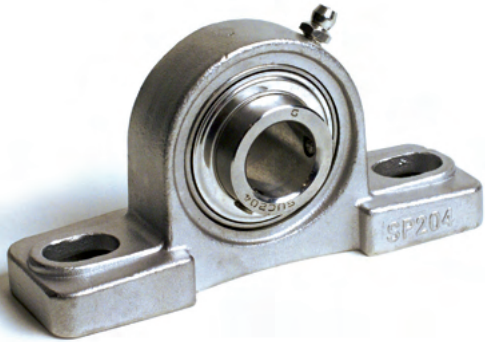

Materiale:

- Supporto: INOX AISI 304
- Cuscinetto: INOX AISI 440

descrizione	codice	d mm	dimensioni (mm)										cuscinetto		Kg.
			M	D	I	G	N	N1	A	L	C	E	codice	carico KN dinamo C statico C ₀	
B-UCP204	SSBUCP204	20	33,3	127	95	15	13	19	65	38	31	12,7	SSBUC204	9880 6200	0,65
B-UCP205	SSBUCP205	25	36,5	140	105	16	13	16	70	38	34	14,3	SSBUC205	10780 6980	0,79
B-UCP206	SSBUCP206	30	42,9	165	121	18	17	21	83	48	38,1	15,9	SSBUC206	14970 10040	1,30
B-UCP207	SSBUCP207	35	47,6	167	127	19	17	21	94	48	42,9	17,5	SSBUC207	19750 13670	1,60
B-UCP208	SSBUCP208	40	49,2	184	137	19	17	25	100	54	49,2	19	SSBUC208	22710 15940	2,00
B-UCP209	SSBUCP209	45	54	190	146	20	17	22	108	54	49,2	19	SSBUC209	24360 17710	2,20
B-UCP210	SSBUCP210	50	57,2	206	159	22	20	25	114	60	51,6	19	SSBUC210	26980 19840	2,80



CUSCINETTI INOX PER SUPPORTI BALL BEARING IN STAINLESS STEEL

CUSCINETTI INOX “B-UC” PER SUPPORTI

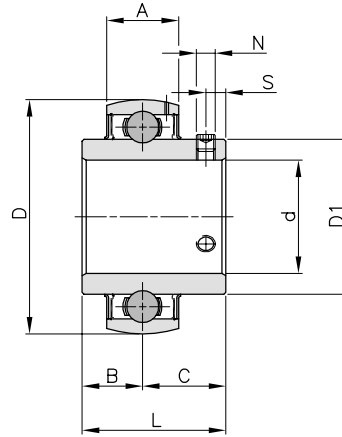

Materiale: INOX AISI 440

descrizione	codice	d mm	dimensioni (mm)								carico KN		Kg.
			D	D1	L	A	B	C	S	N	dinamo C	statico C ₀	
B-UC204	SSBUC204	20	47	29	31	17	12,7	18,3	4,5	M6 x 1	9880	6200	0,16
B-UC205	SSBUC205	25	52	34	34	17	14,3	19,7	5	M6 x 1	10780	6980	0,20
B-UC206	SSBUC206	30	62	40,5	38,1	19	15,9	22,2	5	M6 x 1	14970	10040	0,32
B-UC207	SSBUC207	35	72	48	42,9	20	17,5	25,4	6	M8 x 1	19750	13670	0,48
B-UC208	SSBUC208	40	80	53	49,2	21	19	30,2	8	M8 x 1	22710	15940	0,65
B-UC209	SSBUC209	45	85	57,3	49,2	22	19	30,2	8	M8 x 1	24360	17710	0,70
B-UC210	SSBUC210	50	90	63	51,6	23	19	32,6	9	M10 x 1	26980	19840	0,79



CUSCINETTI RADIALI AD UNA CORONA DI SFERE - SCHERMATI

SEALED RADIAL DEEP GROOVE BALL BEARINGS

I cuscinetti schermati ambo i lati sono identificati dal suffisso ZZ e sono destinati principalmente alle applicazioni dove ruota l'anello interno.
Gli schermi sono costruiti in lamiera di acciaio.
Temperatura di utilizzo da -40° a +120°.

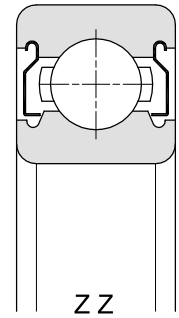
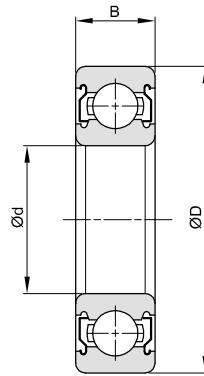

descrizione	codice	d	D	B	coefficiente di carico		numero di giri massimo min ⁻¹	Kg.
					dinamico C KN	statico C ₀ KN		
607 ZZ	BBZZ0607	7	19	6	2,34	0,89	36000	0,008
608 ZZ	BBZZ0608	8	22	7	3,3	1,37	34000	0,012
609 ZZ	BBZZ0609	9	24	7	3,35	1,43	32000	0,015
623 ZZ	BBZZ0623	3	10	4	0,63	0,22	50000	0,002
624 ZZ	BBZZ0624	4	13	5	1,3	0,49	40000	0,003
625 ZZ	BBZZ0625	5	16	5	1,73	0,67	36000	0,005
626 ZZ	BBZZ0626	6	19	6	2,34	0,89	32000	0,008
627 ZZ	BBZZ0627	7	22	7	3,3	1,37	30000	0,013
629 ZZ	BBZZ0629	9	26	8	4,55	1,97	28000	0,019
6000 ZZ	BBZZ06000	10	26	8	4,55	1,97	31000	0,019
6001 ZZ	BBZZ06001	12	28	8	5,1	2,84	27000	0,022
6002 ZZ	BBZZ06002	15	32	9	5,6	2,84	23000	0,030
6003 ZZ	BBZZ06003	17	35	10	6	3,25	21000	0,039
6004 ZZ	BBZZ06004	20	42	12	9,4	5,03	15000	0,069
6005 ZZ	BBZZ06005	25	47	12	10,1	5,85	13000	0,080
6006 ZZ	BBZZ06006	30	55	13	13,2	8,3	10000	0,120
6007 ZZ	BBZZ06007	35	62	14	16	10,4	9000	0,160
6008 ZZ	BBZZ06008	40	68	15	16,8	11,8	8500	0,190
6009 ZZ	BBZZ06009	45	75	16	21	14,8	8000	0,250
6010 ZZ	BBZZ06010	50	80	16	22	16,2	7000	0,260
6011 ZZ	BBZZ06011	55	90	18	28,3	21,3	7500	0,380
6012 ZZ	BBZZ06012	60	95	18	29,5	23,2	6700	0,418
6013 ZZ	BBZZ06013	65	100	18	30,5	25,2	6300	0,438
6014 ZZ	BBZZ06014	70	110	20	38	31	6000	0,607
6200 ZZ	BBZZ06200	10	30	9	5,1	2,39	24000	0,032
6201 ZZ	BBZZ06201	12	32	10	6,8	3,06	22000	0,037
6202 ZZ	BBZZ06202	15	35	11	7,65	3,72	20000	0,045
6203 ZZ	BBZZ06203	17	40	12	9,55	4,79	17000	0,065
6204 ZZ	BBZZ06204	20	47	14	12,8	6,65	14000	0,110
6205 ZZ	BBZZ06205	25	52	15	14	7,88	12000	0,130
6206 ZZ	BBZZ06206	30	62	16	19,5	11,3	9500	0,200
6207 ZZ	BBZZ06207	35	72	17	25,7	15,2	8500	0,290
6208 ZZ	BBZZ06208	40	80	18	29,5	18	8000	0,370
6209 ZZ	BBZZ06209	45	85	19	31,5	20,5	7000	0,410
6210 ZZ	BBZZ06210	50	90	20	35	23,2	6700	0,460
6211 ZZ	BBZZ06211	55	100	21	43,5	29,3	6300	0,610
6212 ZZ	BBZZ06212	60	110	22	52,5	36	6000	0,783
6213 ZZ	BBZZ06213	65	120	23	57	40	5300	0,990
6214 ZZ	BBZZ06214	70	125	24	62	44	5000	1,070
6300 ZZ	BBZZ06300	10	35	11	8,1	3,47	22000	0,053
6301 ZZ	BBZZ06301	12	37	12	9,7	5,09	20000	0,060
6302 ZZ	BBZZ06302	15	42	13	11,4	5,43	17000	0,082
6303 ZZ	BBZZ06303	17	47	14	13,6	6,58	15000	0,120



CUSCINETTI RADIALI AD UNA CORONA DI SFERE - SCHERMATI SEALED RADIAL DEEP GROOVE BALL BEARINGS

I cuscinetti schermati ambo i lati sono identificati dal suffisso ZZ e sono destinati principalmente alle applicazioni dove ruota l'anello interno. Gli schermi sono costruiti in lamiera di acciaio. Temperatura di utilizzo da -40° a +120°.

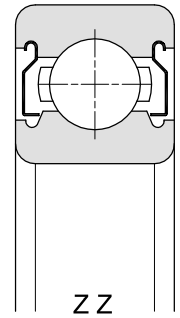
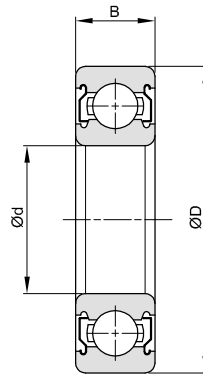

descrizione	codice	d	D	B	coefficiente di carico		numero di giri massimo min ⁻¹	Kg.
					dinamico C KN	statico C ₀ KN		
6304 ZZ	BBZZ06304	20	52	15	15,9	7,88	13000	0,140
6305 ZZ	BBZZ06305	25	62	17	20,6	11,5	10000	0,230
6306 ZZ	BBZZ06306	30	72	19	26,7	15	10400	0,346
6307 ZZ	BBZZ06307	35	80	21	33,5	19,1	9000	0,457
6308 ZZ	BBZZ06308	40	90	23	40,5	24,1	8100	0,633
6309 ZZ	BBZZ06309	45	100	25	52,8	31,8	6300	0,830
6310 ZZ	BBZZ06310	50	110	27	61,8	38,1	6000	1,050
6311 ZZ	BBZZ06311	55	120	29	71,5	44,5	5600	1,370
6312 ZZ	BBZZ06312	60	130	31	82	52	5000	1,700
6313 ZZ	BBZZ06313	65	140	33	92,5	59,5	4800	2,080
6314 ZZ	BBZZ06314	70	150	35	104	68	4500	2,520
61800 ZZ	BBZZ61800	10	19	5	1,72	0,84	24000	0,006
61801 ZZ	BBZZ61801	12	21	5	1,92	1,04	20000	0,006
61802 ZZ	BBZZ61802	15	24	5	2,07	1,26	17000	0,007
61803 ZZ	BBZZ61803	17	26	5	2,63	1,57	15000	0,008
61804 ZZ	BBZZ61804	20	32	7	4	2,47	13000	0,020
61805 ZZ	BBZZ61805	25	37	7	4,5	3,15	10000	0,020
61806 ZZ	BBZZ61806	30	42	7	4,7	3,65	9000	0,030
61900 ZZ	BBZZ61900	10	22	6	2,7	1,27	22000	0,010
61901 ZZ	BBZZ61901	12	24	6	2,89	1,46	20000	0,010
61902 ZZ	BBZZ61902	15	28	7	4,35	2,26	17000	0,020
61903 ZZ	BBZZ61903	17	30	7	4,6	2,55	15000	0,020
61904 ZZ	BBZZ61904	20	37	9	6,4	3,7	12000	0,040
61905 ZZ	BBZZ61905	25	42	9	7,05	4,55	10000	0,050
61906 ZZ	BBZZ61906	30	47	9	7,25	5	8500	0,050
61907 ZZ	BBZZ61907	35	55	10	10,6	7,25	7500	0,080
61908 ZZ	BBZZ61908	40	62	12	13,7	10	6300	0,120



CUSCINETTI RADIALI AD UNA CORONA DI SFERE - CON TENUTA SEALED RADIAL DEEP GROOVE BALL BEARINGS

I cuscinetti con tenuta ambo i lati sono identificati dal suffisso 2RS.

La tenuta è formata esternamente in gomma con un rinforzo interno in lamiera di acciaio.

Ottima resistenza all'olio e all'usura.

Temperatura di utilizzo da -40° a +120°.

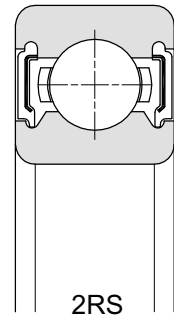
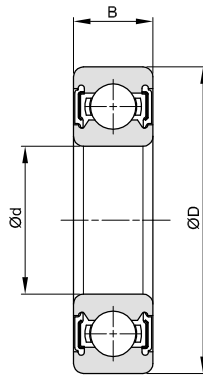

descrizione	codice	d	D	B	coefficiente di carico		numero di giri massimo min ⁻¹	Kg.
					dinamico C KN	statico C ₀ KN		
607 2RS	BB2RS00607	7	19	6	2,34	0,89	22000	0,008
608 2RS	BB2RS00608	8	22	7	3,3	1,37	20000	0,012
609 2RS	BB2RS00609	9	24	7	3,35	1,43	19000	0,015
625 2RS	BB2RS00625	5	16	5	1,73	0,67	25000	0,005
626 2RS	BB2RS00626	6	19	6	2,34	0,89	22000	0,008
627 2RS	BB2RS00627	7	22	7	3,3	1,37	20000	0,013
629 2RS	BB2RS00629	9	26	8	4,55	1,97	18000	0,019
6000 2RS	BB2RS06000	10	26	8	4,55	1,97	19000	0,019
6001 2RS	BB2RS06001	12	28	8	5,1	2,84	17000	0,022
6002 2RS	BB2RS06002	15	32	9	5,6	2,84	14000	0,030
6003 2RS	BB2RS06003	17	35	10	6	3,25	13000	0,039
6004 2RS	BB2RS06004	20	42	12	9,4	5,03	11000	0,069
6005 2RS	BB2RS06005	25	47	12	10,1	5,85	9500	0,080
6006 2RS	BB2RS06006	30	55	13	13,2	8,3	7000	0,120
6007 2RS	BB2RS06007	35	62	14	16	10,4	6300	0,160
6008 2RS	BB2RS06008	40	68	15	16,8	11,8	6300	0,190
6009 2RS	BB2RS06009	45	75	16	21	14,8	5600	0,250
6010 2RS	BB2RS06010	50	80	16	22	16,2	5000	0,260
6011 2RS	BB2RS06011	55	90	18	28,3	21,3	4500	0,380
6012 2RS	BB2RS06012	60	95	18	29,5	23,2	4300	0,418
6013 2RS	BB2RS06013	65	100	18	30,5	25,2	4000	0,438
6014 2RS	BB2RS06014	70	110	20	38	31	3600	0,607
6200 2RS	BB2RS06200	10	30	9	5,1	2,39	17000	0,032
6201 2RS	BB2RS06201	12	32	10	6,8	3,06	15000	0,037
6202 2RS	BB2RS06202	15	35	11	7,65	3,72	12000	0,045
6203 2RS	BB2RS06203	17	40	12	9,55	4,79	12000	0,065
6204 2RS	BB2RS06204	20	47	14	12,8	6,65	10000	0,110
6205 2RS	BB2RS06205	25	52	15	14	7,88	8400	0,130
6206 2RS	BB2RS06206	30	62	16	19,5	11,3	6500	0,200
6207 2RS	BB2RS06207	35	72	17	25,7	15,2	6000	0,290
6208 2RS	BB2RS06208	40	80	18	29,5	18	5600	0,370
6209 2RS	BB2RS06209	45	85	19	31,5	20,5	4900	0,410
6210 2RS	BB2RS06210	50	90	20	35	23,2	4700	0,460
6211 2RS	BB2RS06211	55	100	21	43,5	29,3	4300	0,610
6212 2RS	BB2RS06212	60	110	22	52,5	36	4000	0,783
6213 2RS	BB2RS06213	65	120	23	57	40	3600	0,990
6214 2RS	BB2RS06214	70	125	24	62	44	3400	1,070
6300 2RS	BB2RS06300	10	35	11	8,1	3,47	15000	0,053
6301 2RS	BB2RS06301	12	37	12	9,7	5,09	14000	0,060
6302 2RS	BB2RS06302	15	42	13	11,4	5,43	12000	0,082
6303 2RS	BB2RS06303	17	47	14	13,6	6,6	10500	0,115



CUSCINETTI RADIALI AD UNA CORONA DI SFERE - CON TENUTA

SEALED RADIAL DEEP GROOVE BALL BEARINGS

I cuscinetti con tenuta ambo i lati sono identificati dal suffisso 2RS.
La tenuta è formata esternamente in gomma con un rinforzo interno in lamiera di acciaio.
Ottima resistenza all'olio e all'usura.
Temperatura di utilizzo da -40° a +120°.

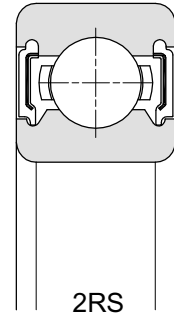
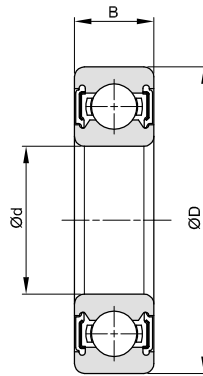

descrizione	codice	d	D	B	coefficiente di carico		numero di giri massimo min ⁻¹	Kg.
					dinamico C KN	statico C ₀ KN		
6304 2RS	BB2RS06304	20	52	15	15,9	7,88	9500	0,140
6305 2RS	BB2RS06305	25	62	17	20,6	11,5	7000	0,230
6306 2RS	BB2RS06306	30	72	19	26,7	15,2	6500	0,350
6307 2RS	BB2RS06307	35	80	21	33,5	19,2	6000	0,460
6308 2RS	BB2RS06308	40	90	23	40,8	24	4900	0,630
6309 2RS	BB2RS06309	45	100	25	52,8	31,8	4400	0,830
6310 2RS	BB2RS06310	50	110	27	61,8	38,1	4200	1,050
6311 2RS	BB2RS06311	55	120	29	71,5	44,5	3800	1,370
6312 2RS	BB2RS06312	60	130	31	82	52	3400	1,700
6313 2RS	BB2RS06313	65	140	33	92,5	59,5	3200	2,080
6314 2RS	BB2RS06314	70	150	35	104	68	3000	2,520
61800 2RS	BB2RS61800	10	19	5	1,72	0,84	17000	0,006
61801 2RS	BB2RS61801	12	21	5	1,92	1,04	14000	0,006
61802 2RS	BB2RS61802	15	24	5	2,07	1,26	12000	0,007
61803 2RS	BB2RS61803	17	26	5	2,63	1,57	10500	0,008
61804 2RS	BB2RS61804	20	32	7	4	2,47	9100	0,020
61805 2RS	BB2RS61805	25	37	7	4,5	3,15	7000	0,020
61806 2RS	BB2RS61806	30	42	7	4,7	3,65	6300	0,030
61900 2RS	BB2RS61900	10	22	6	2,7	1,27	15500	0,010
61901 2RS	BB2RS61901	12	24	6	2,89	1,46	14000	0,010
61902 2RS	BB2RS61902	15	28	7	4,35	2,26	12000	0,020
61903 2RS	BB2RS61903	17	30	7	4,6	2,55	10500	0,020
61904 2RS	BB2RS61904	20	37	9	6,4	3,7	8400	0,040
61905 2RS	BB2RS61905	25	42	9	7,05	4,55	7000	0,050
61906 2RS	BB2RS61906	30	47	9	7,25	5	6000	0,050
61907 2RS	BB2RS61907	35	55	10	10,6	7,25	5300	0,080
61908 2RS	BB2RS61908	40	62	12	13,7	10	4410	0,120

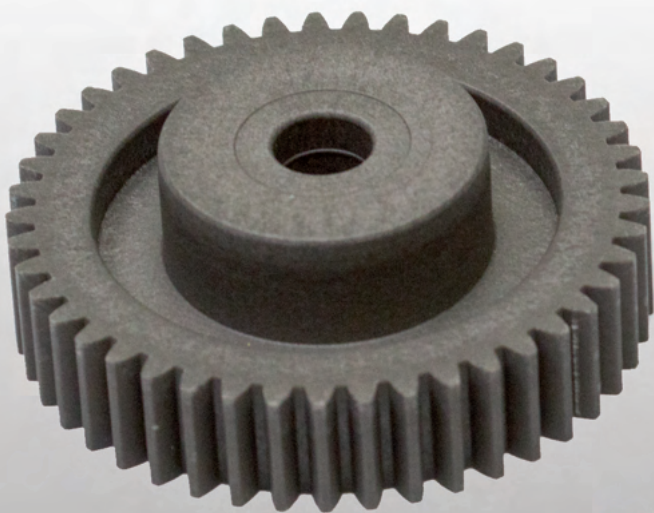

Tendicatena, ruote dentate cilindriche e coniche sono costruite in materiale termoplastico NYLON PA 6 al 30% fibra di vetro colore grigio.

Caratteristiche

- Elevata resistenza meccanica, rigidità, durezza e tenacia
- Elevata resistenza alla torsione
- Buona resistenza alla fatica
- Elevato smorzamento meccanico
- Buona capacità di scorrimento
- Eccellente resistenza all'usura e alle sostanze chimiche
- Buone proprietà di isolamento elettrico

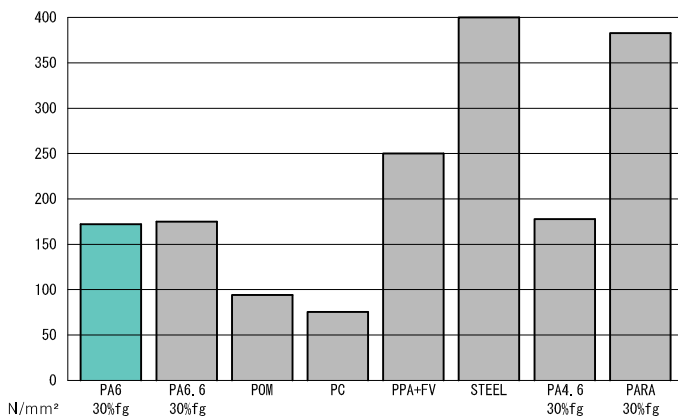
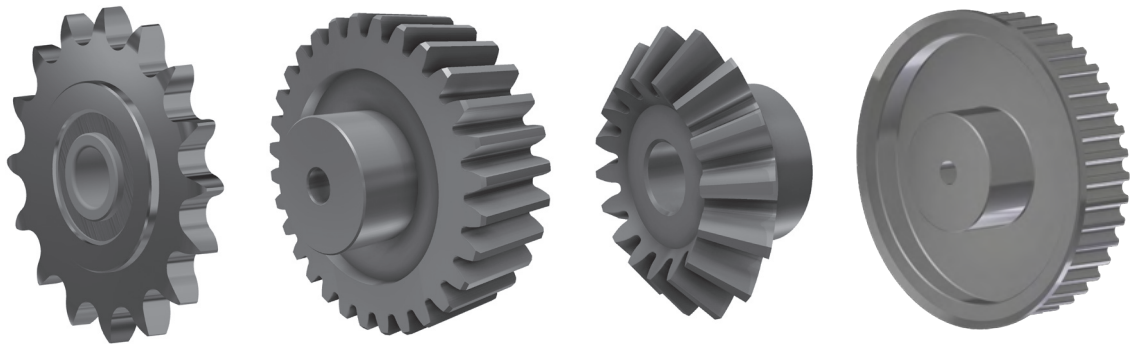

RESISTENZA ALLA FLESSIONE / FLEXING RESISTANCE

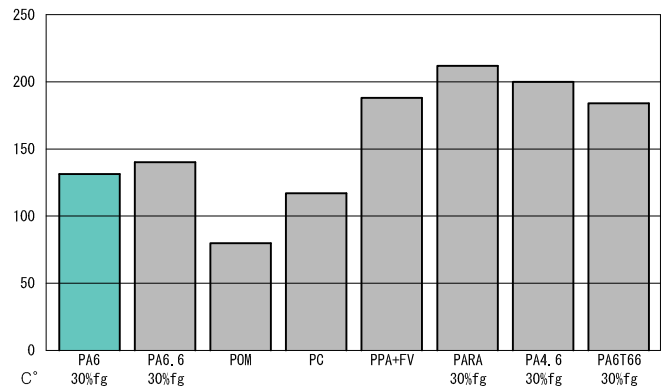

TEMPERATURA MASSIMA IN CONTINUO / MAXIMUM TEMPERATURE OF USE

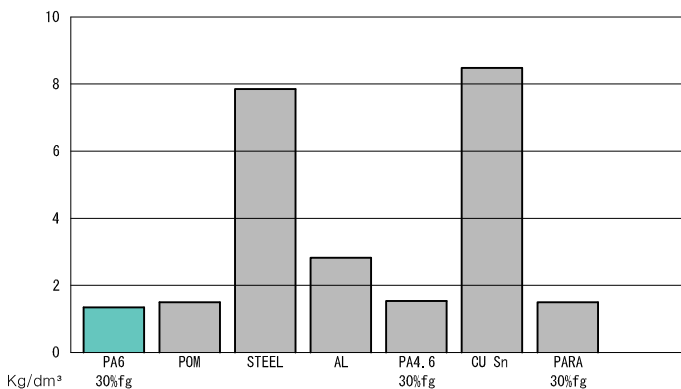

PESO SPECIFICO / SPECIFIC WEIGHT

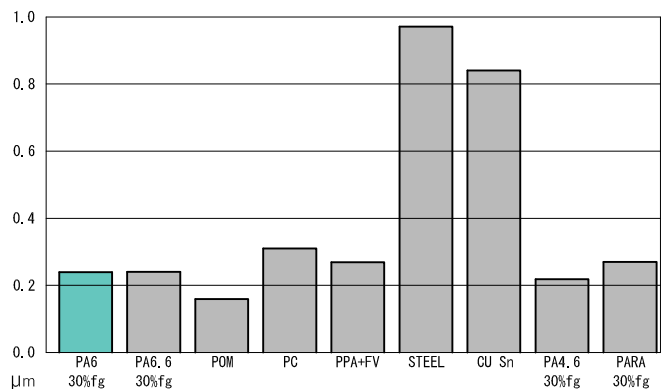

COEFFICIENTE D'ATTRITO / FRICTION COEFFICIENT



PIGNONI TENDICATENA - MATERIALE TERMOPLASTICO

CHAIN-STRETCHER SPROCKETS - THERMOPLASTIC MATERIAL

I pignoni tendicatena vengono forniti pronti per il montaggio.

Sono composti da una ruota in materiale termoplastico montata su un cuscinetto a sfere.

Our chain-stretcher sprockets with ball bearing are supplied "ready for mounting".

They consist of a toothed wheel in thermoplastic material mounted on a ball bearing.

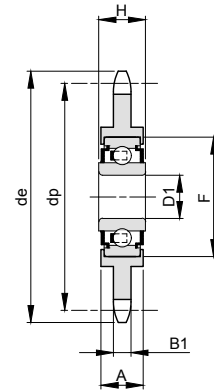
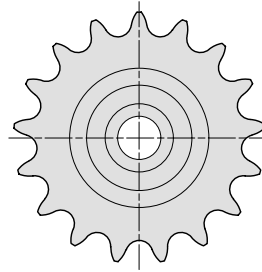

Materiale pignone: NYLON PA6+FV

Z	codice	passo	ISO	de	dp	B1	A	D1	F	H	Kg.	
21	PV364330021	3/8" x 7/32"	06B-1	67,6	63,91	5,3	16	16	+0,26 +0,13	40	18,3	0,10
16	PV364340016	1/2" x 5/16"	08B-1	69,9	65,10	7,2	16	16	+0,26 +0,13	40	18,3	0,10
18	PV364340018	1/2" x 5/16"	08B-1	78,0	73,14	7,2	16	16	+0,26 +0,13	40	18,3	0,11
15	PV364350015	5/8" x 3/8"	10B-1	83,2	76,36	9,1	16	16	+0,26 +0,13	40	18,3	0,13
17	PV364350017	5/8" x 3/8"	10B-1	93,3	86,39	9,1	16	16	+0,26 +0,13	40	18,3	0,14
13	PV364360013	3/4" x 7/16"	12B-1	87,8	79,59	11,1	16	16	+0,26 +0,13	40	18,3	0,12
15	PV364360015	3/4" x 7/16"	12B-1	99,8	91,63	11,1	16	16	+0,26 +0,13	40	18,3	0,13



RUOTE DENTATE CILINDRICHE - MATERIALE TERMOPLASTICO

CYLINDRICAL GEARS - THERMOPLASTIC MATERIAL

MODULO 1
ANGOLO DI PRESSIONE 20°

A	B
25	15

Materiale: **NYLON PA6+FV**

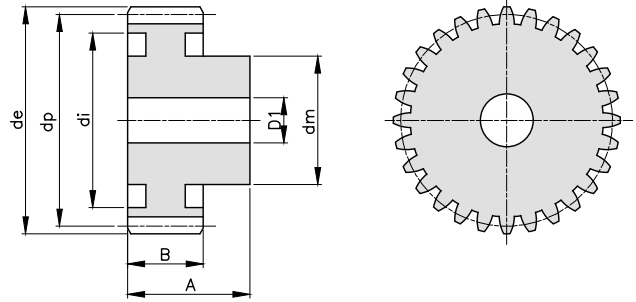

Z	codice	de	dp	di	dm	D1	Kg.
10	PV401010010	12	10		12		0,002
12	PV401010012	14	12		9	4	0,003
13	PV401010013	15	13		10	4	0,003
14	PV401010014	16	14		10	4	0,004
15	PV401010015	17	15		10	4	0,004
16	PV401010016	18	16		13	5	0,005
17	PV401010017	19	17		14	5	0,006
18	PV401010018	20	18		14	5	0,006
19	PV401010019	21	19		14	5	0,007
20	PV401010020	22	20		16	5	0,008
21	PV401010021	23	21		16	5	0,009
22	PV401010022	24	22		18	5	0,009
23	PV401010023	25	23		18	6	0,010
24	PV401010024	26	24		20	6	0,012
25	PV401010025	27	25		20	6	0,011
26	PV401010026	28	26		22	6	0,013
27	PV401010027	29	27		22	6	0,015
28	PV401010028	30	28		22	6	0,015
29	PV401010029	31	29		25	6	0,018
30	PV401010030	32	30		25	6	0,018
31	PV401010031	33	31		25	6	0,019
32	PV401010032	34	32		25	6	0,019
33	PV401010033	35	33		25	6	0,020
34	PV401010034	36	34		30	8	0,024
35	PV401010035	37	35		30	8	0,024
36	PV401010036	38	36		30	8	0,028
37	PV401010037	39	37		30	8	0,026
38	PV401010038	40	38		30	8	0,028
39	PV401010039	41	39		30	8	0,028
40	PV401010040	42	40		30	8	0,029
41	PV401010041	43	41		30	8	0,031
42	PV401010042	44	42		35	10	0,035
43	PV401010043	45	43		35	10	0,035
44	PV401010044	46	44		35	10	0,036
45	PV401010045	47	45		35	10	0,037
47	PV401010047	49	47		35	10	0,041
48	PV401010048	50	48		35	10	0,042
49	PV401010049	51	49		35	10	0,044
50	PV401010050	52	50		35	10	0,045
52	PV401010052	54	52	44	35	14	0,042
55	PV401010055	57	55	44	35	14	0,045
56	PV401010056	58	56	44	35	14	0,053
58	PV401010058	60	58	44	35	14	0,049

Z	codice	de	dp	di	dm	D1	Kg.
60	PV401010060	62	60	51	40	14	0,058
64	PV401010064	66	64	51	40	14	0,064
65	PV401010065	67	65	51	40	20	0,060
70	PV401010070	72	70	61	40	20	0,071
71	PV401010071	73	71	61	40	20	0,072
72	PV401010072	74	72	61	40	20	0,078
73	PV401010073	75	73	61	40	20	0,072
74	PV401010074	76	74	61	40	20	0,072
75	PV401010075	77	75	66	50	20	0,074
77	PV401010077	79	77	66	50	20	0,100
80	PV401010080	82	80	66	50	20	0,097
85	PV401010085	87	85	66	50	20	0,127
88	PV401010088	90	88	66	50	20	0,094
90	PV401010090	92	90	80	50	20	0,115
95	PV401010095	97	95	80	50	20	0,103
100	PV401010100	102	100	87	50	20	0,119
104	PV401010104	106	104	93	50	20	0,109
110	PV401010110	112	110	93	50	20	0,125
120	PV401010120	122	120	109	50	20	0,122



RUOTE DENTATE CILINDRICHE - MATERIALE TERMOPLASTICO

CYLINDRICAL GEARS - THERMOPLASTIC MATERIAL

MODULO 2
ANGOLO DI PRESSIONE 20°

A	B
35	20

Materiale: **NYLON PA6+FV**

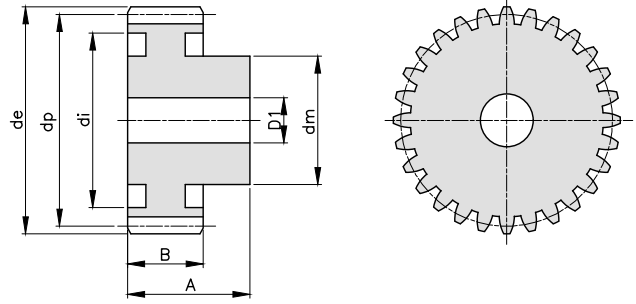

Z	codice	de	dp	di	dm	D1	Kg.
12	PV401020012	28	24		18	8	0,015
13	PV401020013	30	26		18	8	0,017
14	PV401020014	32	28		20	8	0,020
15	PV401020015	34	30		22	8	0,023
16	PV401020016	36	32		25	8	0,029
17	PV401020017	38	34		25	8	0,031
18	PV401020018	40	36		30	10	0,034
19	PV401020019	42	38		30	10	0,040
20	PV401020020	44	40		30	10	0,042
21	PV401020021	46	42		30	10	0,046
22	PV401020022	48	44		30	10	0,049
23	PV401020023	50	46		35	10	0,060
24	PV401020024	52	48		35	10	0,056
25	PV401020025	54	50		35	10	0,066
26	PV401020026	56	52		40	14	0,071
27	PV401020027	58	54		40	14	0,071
28	PV401020028	60	56		40	14	0,074
29	PV401020029	62	58		40	14	0,086
30	PV401020030	64	60		40	14	0,083
31	PV401020031	66	62	48	40	14	0,087
32	PV401020032	68	64	51	45	16	0,095
33	PV401020033	70	66	51	45	16	0,098
34	PV401020034	72	68	51	45	16	0,105
35	PV401020035	74	70	51	45	16	0,113
36	PV401020036	76	72	59	50	16	0,115
37	PV401020037	78	74	59	50	16	0,118
38	PV401020038	80	76	59	50	16	0,125
39	PV401020039	82	78	59	50	16	0,127
40	PV401020040	84	80	66	55	16	0,138
41	PV401020041	86	82	66	55	16	0,152
42	PV401020042	88	84	66	55	16	0,156
43	PV401020043	90	86	66	55	16	0,162
44	PV401020044	92	88	68	60	16	0,175
45	PV401020045	94	90	68	60	16	0,177
46	PV401020046	96	92	75	60	16	0,181
47	PV401020047	98	94	75	60	16	0,188
48	PV401020048	100	96	75	60	16	0,193
49	PV401020049	102	98	84	60	16	0,210
50	PV401020050	104	100	84	60	20	0,209
51	PV401020051	106	102	90	60	20	0,189
52	PV401020052	108	104	90	60	20	0,203
53	PV401020053	110	106	90	60	20	0,207
54	PV401020054	112	108	90	60	20	0,211

Z	codice	de	dp	di	dm	D1	Kg.
55	PV401020055	114	110	90	60	20	0,209
56	PV401020056	116	112	90	60	20	0,181
57	PV401020057	118	114	90	60	20	0,208
58	PV401020058	120	116	90	60	20	0,202
59	PV401020059	122	118	90	60	20	0,230
60	PV401020060	124	120	101	60	20	0,238
61	PV401020061	126	122	101	60	20	0,254
62	PV401020062	128	124	101	60	20	0,257
63	PV401020063	130	126	101	60	20	0,216
64	PV401020064	132	128	101	60	20	0,276
65	PV401020065	134	130	101	60	20	0,226
66	PV401020066	136	132	101	60	20	0,295
67	PV401020067	138	134	101	60	20	0,273
68	PV401020068	140	136	101	60	20	0,265
69	PV401020069	142	138	117	60	20	0,279
70	PV401020070	144	140	117	60	20	0,274
71	PV401020071	146	142	117	60	20	0,275
72	PV401020072	148	144	117	60	20	0,324
73	PV401020073	150	146	117	60	20	0,340
74	PV401020074	152	148	117	60	20	0,340
75	PV401020075	154	150	117	60	20	0,349
76	PV401020076	156	152	117	60	20	0,376
77	PV401020077	158	154	117	60	20	0,379
78	PV401020078	160	156	117	60	20	0,381
79	PV401020079	162	158	117	60	20	0,398
80	PV401020080	164	160	117	60	20	0,292
81	PV401020081	166	162	117	60	20	0,314
82	PV401020082	168	164	147	60	20	0,338
83	PV401020083	170	166	147	60	20	0,313
84	PV401020084	172	168	147	60	20	0,320
85	PV401020085	174	170	147	60	20	0,335
86	PV401020086	176	172	147	60	20	0,383
87	PV401020087	178	174	147	60	20	0,384
88	PV401020088	180	176	147	60	20	0,385
89	PV401020089	182	178	147	60	20	0,404
90	PV401020090	184	180	147	60	20	0,451



RUOTE DENTATE CONICHE DENTI DIRITTI - MATERIALE TERMOPLASTICO CONICAL STRAIGHT TOOTHED GEARS - THERMOPLASTIC MATERIAL

RAPPORTO 1:1

ANGOLO DI PRESSIONE 20°

ANGOLO FRA GLI ALBERI $\Sigma = 90^\circ$

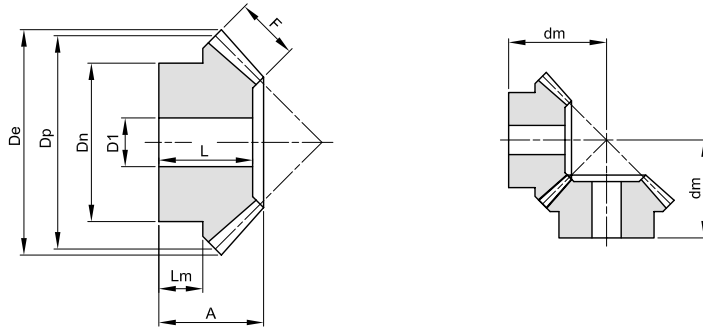

Materiale: NYLON PA6+FV

modulo	denti	codice	De	Dp	A	F	Dn	D1	dm	L	Lm	Kg.
1	16	PV421010016	17,4	16	14	4	13,5	5	18,6	14	9,5	0,002
1,5	16	PV421015016	26,1	24	18	5,5	20	8	25,1	18	12	0,006
1,5	20	PV421015020	32,1	30	20	10	22,5	6	28,7	20	8,5	0,011
1,5	30	PV421015030	47,1	45	25	10	34,5	12	39,7	25	13	0,030
2	16	PV421020016	34,8	32	20	9	25	9	28,8	20	9	0,012
2	20	PV421020020	42,8	40	27	13	32,5	9	35,7	27	13,5	0,028
2	30	PV421020030	62,8	60	30	16	50,5	12	47,8	30	12,8	0,074
2,5	16	PV421025016	43,5	40	28	10	30	12	37,3	28	15,5	0,025
2,5	20	PV421025020	53,5	50	30	12,5	38,5	12	45,9	26	16	0,043
2,5	30	PV421025030	78,5	75	35	18	51	14	59,1	31	15,5	0,107
3	16	PV421030016	52,2	48	31	13	38	11	44,2	31	16,2	0,043
3	20	PV421030020	64,2	60	35	18	43,5	14	51,1	35	15	0,071
3	30	PV421030030	94,2	90	40	22	61	20	68,1	36,5	18,5	0,178
3,5	20	PV421035020	74,9	70	39	22	56,5	14	58,6	35,5	16,5	0,117



RUOTE DENTATE CONICHE DENTI DIRITTI - MATERIALE TERMOPLASTICO CONICAL STRAIGHT TOOTHED GEARS - THERMOPLASTIC MATERIAL

RAPPORTO 1:2

ANGOLO DI PRESSIONE 20°

ANGOLO FRA GLI ALBERI $\Sigma = 90^\circ$

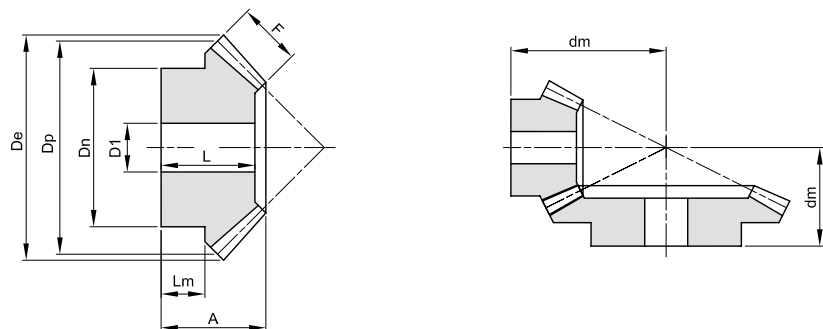

Materiale: NYLON PA6+FV

modulo	denti	codice	De	Dp	A	F	Dn	D1	dm	L	Lm	Kg.
1,5	16	PV422015016	26,7	24	20	8	17,5	8	36,4	20	10,5	0,006
1,5	32	PV422015032	49,3	48	19,5	8	33	12	27,5	19,5	11,5	0,026
2	16	PV422020016	35,6	32	23	10	23,5	10	45,4	23	11,5	0,013
2	32	PV422020032	65,8	64	25	12	40,5	12	35,2	25	10	0,055
2,5	16	PV422025016	44,4	40	27,5	12	30	12	56	27,5	13,5	0,026
2,5	32	PV422025032	82,2	80	31	13	50	15	43,5	25,5	15,5	0,101
3	16	PV422030016	53,4	48	28	15	40,5	12	61,6	28	12	0,043
3	32	PV422030032	98,7	96	34,5	18	61	16	50,4	34,5	16	0,182



PULEGGE DENTATE - MATERIALE TERMOPLASTICO

TIMING BELTS PULLEYS - THERMOPLASTIC MATERIAL

MXL 025

PASSO 0,80" (2,032 mm)

PER CINGHIE LARGHEZZA 1/4" (6,35 mm)

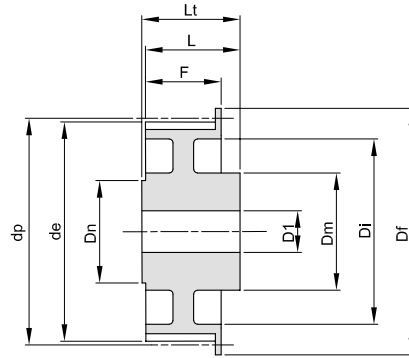

Materiale: NYLON PA6+FV

descrizione	codice	dent	dp	de	Df	Dm	Dn	Di	F	L	Lt	D1	Kg.
10 MXL 025	PV12025010	10	6,47	5,96	12	12	4		9,5	17,5	19	3	0,002
11 MXL 025	PV12025011	11	7,11	6,61	12	12	4		9,5	17,5	19	3	0,002
12 MXL 025	PV12025012	12	7,76	7,25	12	12	4		9,5	17,5	19	3	0,002
13 MXL 025	PV12025013	13	8,41	7,90	12	12	4		9,5	17,5	19	3	0,002
14 MXL 025	PV12025014	14	9,06	8,55	12	12	4		9,5	17,5	19	3	0,002
15 MXL 025	PV12025015	15	9,70	9,19	12	12	4		9,5	17,5	19	3	0,002
16 MXL 025	PV12025016	16	10,35	9,84	12	12	4		9,5	17,5	19	3	0,002
17 MXL 025	PV12025017	17	11,00	10,49	12	12	4		9,5	17,5	19	3	0,002
18 MXL 025	PV12025018	18	11,64	11,13	16	14	8		9,5	17,5	19	3	0,003
19 MXL 025	PV12025019	19	12,29	11,78	16	14	8		9,5	17,5	19	3	0,003
20 MXL 025	PV12025020	20	12,94	12,43	16	14	8		9,5	17,5	19	3	0,003
21 MXL 025	PV12025021	21	13,58	13,07	16	14	8		9,5	17,5	19	3	0,003
22 MXL 025	PV12025022	22	14,23	13,72	18	14	10		9,5	17,5	19	4	0,003
23 MXL 025	PV12025023	23	14,88	14,37	18	14	10		9,5	17,5	19	4	0,004
24 MXL 025	PV12025024	24	15,52	15,02	20	14	12		9,5	17,5	19	4	0,004
25 MXL 025	PV12025025	25	16,17	15,66	20	14	12		9,5	17,5	19	4	0,004
26 MXL 025	PV12025026	26	16,82	16,31	20	16	12		9,5	17,5	19	4	0,005
27 MXL 025	PV12025027	27	17,46	16,96	20	16	12		9,5	17,5	19	4	0,005
28 MXL 025	PV12025028	28	18,11	17,60	22	16	12		9,5	17,5	19	4	0,005
29 MXL 025	PV12025029	29	18,76	18,25	22	16	12		9,5	17,5	19	4	0,005
30 MXL 025	PV12025030	30	19,40	18,90	24	18	14		9,5	17,5	19	5	0,006



PULEGGE DENTATE - MATERIALE TERMOPLASTICO

TIMING BELTS PULLEYS - THERMOPLASTIC MATERIAL

XL 037

PASSO 1/5" (5,08 mm)

PER CINGHIE LARGHEZZA 3/8" (9,52 mm)

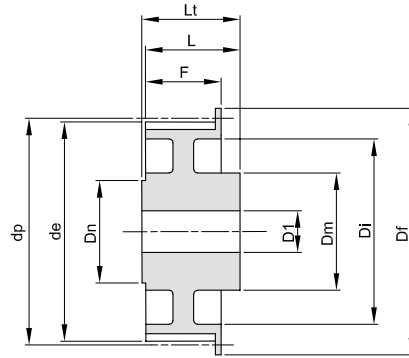

Materiale: NYLON PA6+FV

descrizione	codice	denti	dp	de	Df	Dm	Dn	Di	F	L	Lt	D1	Kg.
10 XL 037	PV13037010	10	16,17	15,66	22	16	12		15,3	23	25	3	0,006
11 XL 037	PV13037011	11	17,79	17,28	24	16	12		15,3	23	25	3	0,007
12 XL 037	PV13037012	12	19,40	18,90	28	16	12		15,3	23	25	3	0,008
13 XL 037	PV13037013	13	21,02	20,51	28	16	12		15,3	23	25	3	0,009
14 XL 037	PV13037014	14	22,64	22,13	28	16	12		15,3	23	25	3	0,010
15 XL 037	PV13037015	15	24,26	23,75	28	16	12		15,3	23	25	3	0,010
16 XL 037	PV13037016	16	25,87	25,36	30	16	12		15,3	23	25	5	0,012
17 XL 037	PV13037017	17	27,49	26,98	32	18	16		15,3	23	25	5	0,014
18 XL 037	PV13037018	18	29,11	28,60	36	20	16		15,3	23	25	6	0,016
19 XL 037	PV13037019	19	30,72	30,22	36	22	16		15,3	23	25	6	0,018
20 XL 037	PV13037020	20	32,34	31,83	38	22	18		15,3	23	25	6	0,020
21 XL 037	PV13037021	21	33,96	33,45	38	24	20		15,3	23	25	6	0,020
22 XL 037	PV13037022	22	35,57	35,07	42	24	20		15,3	23	25	6	0,024
23 XL 037	PV13037023	23	37,19	36,68	42	24	20		15,3	23	25	6	0,025
24 XL 037	PV13037024	24	38,81	38,30	44	25	24		15,3	23	25	8	0,028
25 XL 037	PV13037025	25	40,43	39,92	44	25	24		15,3	23	25	8	0,029
27 XL 037	PV13037027	27	43,66	43,15	50	28	26		15,3	23	25	8	0,033
28 XL 037	PV13037028	28	45,28	44,77	50	28	26		15,3	23	25	8	0,037
30 XL 037	PV13037030	30	48,51	48,00	54	30	24		15,3	23	25	10	0,042
32 XL 037	PV13037032	32	51,74	51,24	57	30	24		15,3	23	25	10	0,047
34 XL 037	PV13037034	34	54,98	54,47	60	30	24		15,3	23	25	10	0,052
35 XL 037	PV13037035	35	56,60	56,09	63	35	24	44	15,3	23	25	10	0,050
40 XL 037	PV13037040	40	64,68	64,17	74	35	30	50	15,3	23	25	10	0,062
42 XL 037	PV13037042	42	67,91	67,41	75	35	30	53	15,3	23	25	10	0,064
48 XL 037	PV13037048	48	77,62	77,11	85	36	30	64	15,3	23	25	10	0,072
60 XL 037	PV13037060	60	97,02	96,51	103	50	34	84	15,3	23	25	20	0,112
72 XL 037	PV13037072	72	116,43	115,92	122	50	40	104	15,3	23	25	20	0,132



PULEGGE DENTATE - MATERIALE TERMOPLASTICO

TIMING BELTS PULLEYS - THERMOPLASTIC MATERIAL

3M

PASSO 3 mm

PER CINGHIE LARGHEZZA 9 mm

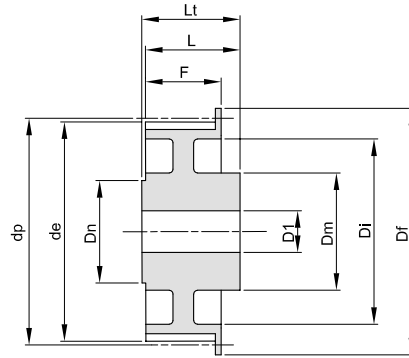

Materiale: NYLON PA6+FV

descrizione	codice	denti	dp	de	Df	Dm	Dn	Di	F	L	Lt	D1	Kg.
10 3M 09	PV40009010	10	9,55	8,79	12	12	4		15,5	23,5	25	3	0,002
11 3M 09	PV40009011	11	10,50	9,74	12	12	4		15,5	23,5	25	3	0,002
12 3M 09	PV40009012	12	11,46	10,70	16	14	4		15,5	23,5	25	3	0,003
13 3M 09	PV40009013	13	12,41	11,65	16	14	4		15,5	23,5	25	3	0,004
14 3M 09	PV40009014	14	13,37	12,61	18	14	4		15,5	23,5	25	3	0,004
15 3M 09	PV40009015	15	14,32	13,56	18	14	4		15,5	23,5	25	3	0,004
16 3M 09	PV40009016	16	15,28	14,52	20	14	8		15,5	23,5	25	3	0,005
17 3M 09	PV40009017	17	16,23	15,47	20	14	8		15,5	23,5	25	3	0,005
18 3M 09	PV40009018	18	17,19	16,43	22	14	12		15,5	23,5	25	3	0,005
19 3M 09	PV40009019	19	18,14	17,38	22	14	12		15,5	23,5	25	3	0,006
20 3M 09	PV40009020	20	19,10	18,34	24	16	14		15,5	23,5	25	3	0,007
21 3M 09	PV40009021	21	20,05	19,29	24	16	14		15,5	23,5	25	3	0,008
22 3M 09	PV40009022	22	21,01	20,25	26	16	16		15,5	23,5	25	4	0,008
23 3M 09	PV40009023	23	21,96	21,20	26	16	16		15,5	23,5	25	4	0,009
24 3M 09	PV40009024	24	22,92	22,16	28	18	18		15,5	23,5	25	4	0,010
25 3M 09	PV40009025	25	23,87	23,11	28	18	18		15,5	23,5	25	4	0,011
26 3M 09	PV40009026	26	24,83	24,07	30	22	18		15,5	23,5	25	5	0,013
27 3M 09	PV40009027	27	25,78	25,02	30	22	18		15,5	23,5	25	5	0,013
28 3M 09	PV40009028	28	26,74	25,98	32	22	18		15,5	23,5	25	5	0,013
29 3M 09	PV40009029	29	27,69	26,93	32	22	18		15,5	23,5	25	5	0,015
30 3M 09	PV40009030	30	28,65	27,89	32	24	18		15,5	23,5	25	5	0,016
31 3M 09	PV40009031	31	29,60	28,84	32	24	18		15,5	23,5	25	5	0,017
32 3M 09	PV40009032	32	30,56	29,80	34	26	18		15,5	23,5	25	6	0,018
33 3M 09	PV40009033	33	31,51	30,75	34	26	18		15,5	23,0	25	6	0,019
35 3M 09	PV40009035	35	33,42	32,66	38	26	20		15,5	23,0	25	8	0,021
40 3M 09	PV40009040	40	38,20	37,44	42	26	20		15,5	23,0	25	8	0,023



PULEGGE DENTATE - MATERIALE TERMOPLASTICO

TIMING BELTS PULLEYS - THERMOPLASTIC MATERIAL

5M

PASSO 5 mm

PER CINGHIE LARGHEZZA 9 mm

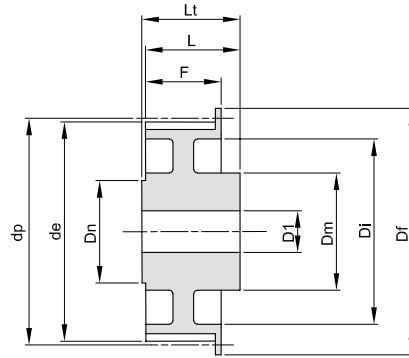

Materiale: NYLON PA6+FV

descrizione	codice	denti	dp	de	Df	Dm	Dn	Di	F	L	Lt	D1	Kg.
12 5M 09	PV41009012	12	19,10	17,95	22	18	12		15,3	23,5	25,5	6	0,007
14 5M 09	PV41009014	14	22,28	21,14	24	18	12		15,3	23,5	25,5	6	0,009
15 5M 09	PV41009015	15	23,87	22,73	28	18	12		15,3	23,5	25,5	6	0,010
16 5M 09	PV41009016	16	25,46	24,32	28	18	12		15,3	23,5	25,5	6	0,011
18 5M 09	PV41009018	18	28,65	27,50	32	18	16		15,3	23,5	25,5	6	0,014
20 5M 09	PV41009020	20	31,83	30,69	36	25	16		15,3	23,5	25,5	6	0,018
21 5M 09	PV41009021	21	33,42	32,28	36	25	16		15,3	23,5	25,5	6	0,020
22 5M 09	PV41009022	22	35,01	33,87	38	25	20		15,3	23,5	25,5	6	0,022
24 5M 09	PV41009024	24	38,20	37,05	42	25	20		15,3	23,5	25,5	6	0,026
26 5M 09	PV41009026	26	41,38	40,24	44	26	24	31	15,3	23,5	25,5	6	0,028
28 5M 09	PV41009028	28	44,56	43,42	48	26	24	31	15,3	23,5	25,5	6	0,032
30 5M 09	PV41009030	30	47,75	46,60	54	26	24	31	15,3	23,5	25,5	6	0,035
32 5M 09	PV41009032	32	50,93	49,79	57	34	30	40	15,3	23,5	25,5	8	0,044
36 5M 09	PV41009036	36	57,30	56,15	60	34	30	40	15,3	23,5	25,5	8	0,053
40 5M 09	PV41009040	40	63,66	62,52	71	34	30	40	15,3	23,5	25,5	8	0,066
44 5M 09	PV41009044	44	70,03	68,88	75	34	30	59	15,3	23,5	25,5	8	0,056
48 5M 09	PV41009048	48	76,39	75,25	84	34	30	59	15,3	23,5	25,5	8	0,072
60 5M 09	PV41009060	60	95,49	94,35	99	45	40	84	15,3	23,5	25,5	8	0,100
72 5M 09	PV41009072	72	114,59	113,45	122	45	40	84	15,3	23,5	25,5	8	0,160



PULEGGE DENTATE - MATERIALE TERMOPLASTICO

TIMING BELTS PULLEYS - THERMOPLASTIC MATERIAL

5M

PASSO 5 mm

PER CINGHIE LARGHEZZA 15 mm

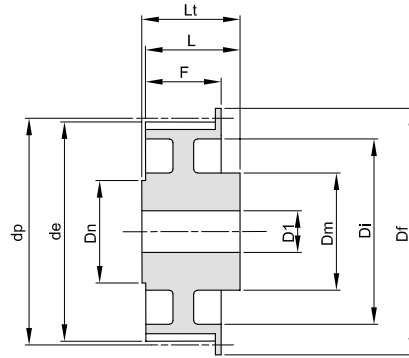

Materiale: NYLON PA6+FV

descrizione	codice	denti	dp	de	Df	Dm	Dn	Di	F	L	Lt	D1	Kg.
12 5M 15	PV41015012	12	19,10	17,95	22	18	12		21	28	30	6	0,008
14 5M 15	PV41015014	14	22,28	21,14	24	18	12		21	28	30	6	0,010
15 5M 15	PV41015015	15	23,87	22,73	28	18	12		21	28	30	6	0,012
16 5M 15	PV41015016	16	25,46	24,32	28	18	12		21	28	30	6	0,013
18 5M 15	PV41015018	18	28,65	27,50	32	18	16		21	28	30	6	0,017
20 5M 15	PV41015020	20	31,83	30,69	36	25	16		21	28	30	6	0,023
21 5M 15	PV41015021	21	33,42	32,28	36	25	16		21	28	30	6	0,025
22 5M 15	PV41015022	22	35,01	33,87	38	25	20		21	28	30	6	0,027
24 5M 15	PV41015024	24	38,20	37,05	42	25	20		21	28	30	6	0,032
26 5M 15	PV41015026	26	41,38	40,24	44	26	24	31	21	28	30	6	0,034
28 5M 15	PV41015028	28	44,56	43,42	48	26	24	31	21	28	30	6	0,040
30 5M 15	PV41015030	30	47,75	46,60	54	26	24	31	21	28	30	6	0,046
32 5M 15	PV41015032	32	50,93	49,79	57	34	30	40	21	28	30	8	0,053
36 5M 15	PV41015036	36	57,30	56,15	60	34	30	40	21	28	30	8	0,066
40 5M 15	PV41015040	40	63,66	62,52	71	34	30	40	21	28	30	8	0,081
44 5M 15	PV41015044	44	70,03	68,88	75	34	30	59	21	28	30	8	0,070
48 5M 15	PV41015048	48	76,39	75,25	84	34	30	59	21	28	30	8	0,090
60 5M 15	PV41015060	60	95,49	94,35	99	45	40	84	21	28	30	8	0,120
72 5M 15	PV41015072	72	114,59	113,45	122	45	40	84	21	28	30	8	0,200



PULEGGE DENTATE - MATERIALE TERMOPLASTICO

TIMING BELTS PULLEYS - THERMOPLASTIC MATERIAL

5M

PASSO 5 mm

PER CINGHIE LARGHEZZA 25 mm

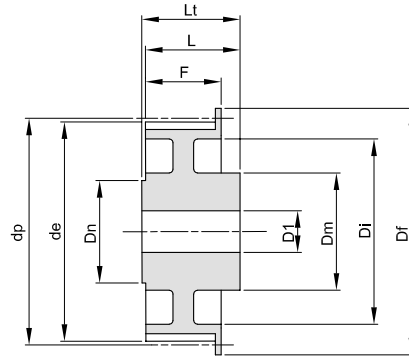

Materiale: NYLON PA6+FV

descrizione	codice	denti	dp	de	Df	Dm	Dn	Di	F	L	Lt	D1	Kg.
12 5M 25	PV41025012	12	19,10	17,95	22	18	12		31	38	40	6	0,010
14 5M 25	PV41025014	14	22,28	21,14	24	18	12		31	38	40	6	0,013
15 5M 25	PV41025015	15	23,87	22,73	28	18	12		31	38	40	6	0,016
16 5M 25	PV41025016	16	25,46	24,32	28	18	12		31	38	40	6	0,018
18 5M 25	PV41025018	18	28,65	27,50	32	25	16		31	38	40	6	0,023
20 5M 25	PV41025020	20	31,83	30,69	36	25	16		31	38	40	6	0,030
21 5M 25	PV41025021	21	33,42	32,28	36	25	16		31	38	40	6	0,033
22 5M 25	PV41025022	22	35,01	33,87	38	25	20		31	38	40	6	0,036
24 5M 25	PV41025024	24	38,20	37,05	42	25	20		31	38	40	6	0,043
26 5M 25	PV41025026	26	41,38	40,24	44	26	24	31	31	38	40	8	0,046
28 5M 25	PV41025028	28	44,56	43,42	48	26	24	31	31	38	40	8	0,054
30 5M 25	PV41025030	30	47,75	46,60	54	26	24	31	31	38	40	8	0,063
32 5M 25	PV41025032	32	50,93	49,79	57	34	30	40	31	38	40	8	0,072
36 5M 25	PV41025036	36	57,30	56,15	60	34	30	40	31	38	40	8	0,090
40 5M 25	PV41025040	40	63,66	62,52	71	34	30	40	31	38	40	8	0,116
44 5M 25	PV41025044	44	70,03	68,88	75	34	30	57	31	38	40	10	0,100
48 5M 25	PV41025048	48	76,39	75,25	84	34	30	57	31	38	40	10	0,130
60 5M 25	PV41025060	60	95,49	94,35	99	45	40	83	31	38	40	10	0,160
72 5M 25	PV41025072	72	114,59	113,45	122	45	40	83	31	38	40	10	0,280



PULEGGE DENTATE - MATERIALE TERMOPLASTICO

TIMING BELTS PULLEYS - THERMOPLASTIC MATERIAL

8M

PASSO 8 mm

PER CINGHIE LARGHEZZA 20 mm

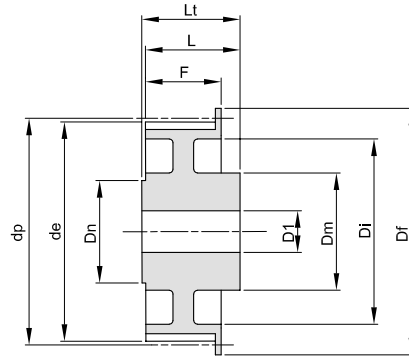

Materiale: NYLON PA6+FV

descrizione	codice	denti	dp	de	Df	Dm	Dn	Di	F	L	Lt	D1	Kg.
16 8M 20	PV42020016	16	40,74	39,37	44	35	24		28	38	40	8	0,048
18 8M 20	PV42020018	18	45,84	44,46	48	35	24		28	38	40	8	0,060
20 8M 20	PV42020020	20	50,93	49,56	54	35	24		28	38	40	8	0,073
22 8M 20	PV42020022	22	56,02	54,65	57	35	30		28	38	40	8	0,087
24 8M 20	PV42020024	24	61,12	59,74	67	35	30		28	38	40	8	0,100
26 8M 20	PV42020026	26	66,21	64,84	71	48	30	49	28	38	40	10	0,120
28 8M 20	PV42020028	28	71,30	69,93	75	48	30	49	28	38	40	10	0,140
30 8M 20	PV42020030	30	76,39	75,02	83	48	40	59	28	38	40	10	0,150
32 8M 20	PV42020032	32	81,49	80,12	87	48	40	59	28	38	40	10	0,170
34 8M 20	PV42020034	34	86,58	85,21	91	48	40	59	28	38	40	10	0,189
36 8M 20	PV42020036	36	91,67	90,30	94	48	40	59	28	38	40	10	0,215
38 8M 20	PV42020038	38	96,77	95,39	99	55	40	80	28	38	40	14	0,200
40 8M 20	PV42020040	40	101,86	100,49	106	55	40	80	28	38	40	14	0,220
44 8M 20	PV42020044	44	112,05	110,67	122	55	40	80	28	38	40	14	0,280
48 8M 20	PV42020048	48	122,23	120,86	125	55	40	105	28	38	40	14	0,240
56 8M 20	PV42020056	56	142,60	141,23	145	55	40	105	28	38	40	14	0,380



PULEGGE DENTATE - MATERIALE TERMOPLASTICO

TIMING BELTS PULLEYS - THERMOPLASTIC MATERIAL

T 2,5

PASSO 2,5 mm

PER CINGHIE LARGHEZZA 6 mm

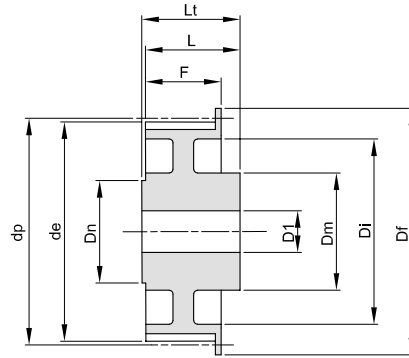

Materiale: NYLON PA6+FV

descrizione	codice	denti	dp	de	Df	Dm	Dn	Di	F	L	Lt	D1	Kg.
19 T 2,5 10	PV26006010	10	7,96	7,36	12	12	4		9,5	17,5	19	3	0,002
19 T 2,5 11	PV26006011	11	8,75	8,15	12	12	4		9,5	17,5	19	3	0,002
19 T 2,5 12	PV26006012	12	9,55	8,95	12	12	4		9,5	17,5	19	3	0,002
19 T 2,5 13	PV26006013	13	10,35	9,75	12	12	4		9,5	17,5	19	3	0,002
19 T 2,5 14	PV26006014	14	11,14	10,54	15	12	4		9,5	17,5	19	3	0,002
19 T 2,5 15	PV26006015	15	11,94	11,34	15	12	4		9,5	17,5	19	3	0,002
19 T 2,5 16	PV26006016	16	12,73	12,13	16	12	8		9,5	17,5	19	3	0,003
19 T 2,5 17	PV26006017	17	13,53	12,93	16	12	8		9,5	17,5	19	3	0,003
19 T 2,5 18	PV26006018	18	14,32	13,72	18	14	8		9,5	17,5	19	3	0,003
19 T 2,5 19	PV26006019	19	15,12	14,52	18	14	8		9,5	17,5	19	3	0,004
19 T 2,5 20	PV26006020	20	15,92	15,32	20	14	10		9,5	17,5	19	3	0,004
19 T 2,5 21	PV26006021	21	16,71	16,11	20	14	10		9,5	17,5	19	3	0,004
19 T 2,5 22	PV26006022	22	17,51	16,91	22	14	12		9,5	17,5	19	4	0,004
19 T 2,5 23	PV26006023	23	18,30	17,70	22	14	12		9,5	17,5	19	4	0,005
19 T 2,5 24	PV26006024	24	19,10	18,50	24	14	12		9,5	17,5	19	4	0,005
19 T 2,5 25	PV26006025	25	19,89	19,29	24	14	12		9,5	17,5	19	4	0,005
19 T 2,5 26	PV26006026	26	20,69	20,09	26	16	16		9,5	17,5	19	4	0,006
19 T 2,5 27	PV26006027	27	21,49	20,89	26	16	16		9,5	17,5	19	4	0,006
19 T 2,5 28	PV26006028	28	22,28	21,68	28	16	18		9,5	17,5	19	4	0,007
19 T 2,5 29	PV26006029	29	23,08	22,48	28	16	18		9,5	17,5	19	4	0,007
19 T 2,5 30	PV26006030	30	23,87	23,27	30	18	18		9,5	17,5	19	5	0,008
19 T 2,5 31	PV26006031	31	24,67	24,07	30	18	18		9,5	17,5	19	5	0,008
19 T 2,5 32	PV26006032	32	25,46	24,86	32	18	18		9,5	17,5	19	5	0,009
19 T 2,5 33	PV26006033	33	26,26	25,66	32	18	18		11,0	17,5	19	5	0,009
19 T 2,5 34	PV26006034	34	27,06	26,46	33	20	20		11,0	17,0	19	5	0,011
19 T 2,5 35	PV26006035	35	27,85	27,25	33	20	20		11,0	17,0	19	5	0,012
19 T 2,5 36	PV26006036	36	28,65	28,05	36	20	20		11,0	17,0	19	5	0,012
19 T 2,5 48	PV26006048	48	38,20	37,60	44	25	26		11,0	17,0	19	5	0,021
19 T 2,5 60	PV26006060	60	47,75	47,15	54	25	26		11,0	17,0	19	5	0,030

CONDIZIONI GENERALI DI VENDITA

1) ORDINI - Gli ordini per materiali standard e speciale devono essere sempre riferiti alle offerte della BEA INGRANAGGI S.p.A. Le ordinazioni sono impegnative per il cliente. Una volta iniziata la lavorazione non si accettano annullamenti o riduzioni dell'ordine salvo il risarcimento da parte del cliente dei costi di materiale e di lavorazione sostenuti fino al momento della sospensione. La quantità spedita può variare del \pm 5% rispetto alla quantità ordinata.

2) PREZZI - Si intendono quelli in vigore alla data dell'ordine. Tutti i prezzi sono per merce resa franco Premezzo, imballo escluso. Qualora nel corso della fornitura si verificassero aumenti nel materiale o negli altri costi di produzione è facoltà della BEA INGRANAGGI S.p.A. di adeguare i prezzi, anche per gli ordini in corso, agli aumenti verificatisi.

3) TERMINI DI CONSEGNA - Sono da considerarsi validi solo i termini di consegna indicati dalla BEA INGRANAGGI S.p.A. Essi sono da considerarsi comunque solo indicativi. Nei casi di difficoltà nell'approvvigionamento dei materiali, di sciopero o comunque in tutti i casi di forza maggiore, i termini di consegna vengono automaticamente prorogati senza che la BEA INGRANAGGI S.p.A. sia tenuta a corrispondere indennizzi di sorta. Il cliente ha in ogni caso l'obbligo del ritiro del materiale speciale ordinato all'approntamento.

4) SPEDIZIONI - Le spedizioni si intendono a carico del committente ed eseguite a suo rischio e pericolo anche quelle franco di porto. I reclami per eventuali ammanchi devono presentarsi entro 8 gg. dal ricevimento della merce. Qualora venga pattuito che il costo del trasporto sia a carico, anche solo in parte, della BEA INGRANAGGI S.p.A., questa si riserva il diritto di scegliere il mezzo di spedizione più economico.

5) L'imballo è fatturato al prezzo di costo.

6) GARANZIA - La ditta BEA INGRANAGGI S.p.A. si impegna a riparare o sostituire gratuitamente quei pezzi da essa riconosciuti difettosi. La merce contestata dev'essere resa alla sede della BEA INGRANAGGI S.p.A. franco di ogni spesa. La garanzia decade qualora i pezzi resi come difettosi siano stati riparati o manomessi. Le riparazioni di pezzi difettosi eseguite dal committente saranno riconosciute solamente dietro autorizzazione della BEA INGRANAGGI S.p.A. e dopo approvazione di essa al preventivo di spesa. La BEA INGRANAGGI S.p.A. non assume responsabilità nè riconosce indennizzi di sorta per i danni che si verificassero durante l'impiego dei suoi prodotti anche se difettosi.

7) PAGAMENTI - Saranno riconosciuti validi solo i pagamenti effettuati nei modi e nei termini pattuiti. Trascorso il termine di pagamento la BEA INGRANAGGI S.p.A. conteggerà gli interessi di mora al tasso del 3% superiore a quello legale, fermo il diritto di esigere il pagamento. In caso di ritardato o mancato pagamento da parte del committente la ditta BEA INGRANAGGI S.p.A. si riserva il diritto di sospendere le consegne degli ordini in corso o di pretendere il pagamento anticipato senza riconoscere al committente indennizzi di sorta o risarcimenti. Qualsiasi contestazione dei materiali in corso di fabbricazione o già in possesso del committente non libera quest'ultimo dall'effettuare il pagamento alla scadenza stabilita e per l'intero ammontare della fattura senza alcuna detrazione.

8) PROPRIETÀ - Tutta la merce spedita rimane sempre di proprietà della Ditta BEA INGRANAGGI S.p.A. fino al pagamento completo delle sue fatture.

9) FORO COMPETENTE - Qualsiasi controversia inerente ai rapporti commerciali con la BEA INGRANAGGI S.p.A. sarà di competenza del Tribunale di Busto Arsizio.

GENERAL TERMS OF SALE

1) ORDERS - Orders for standard and special materials or to drawing must always refer to messrs BEA's offer. Orders are compelling for client and from starting of production, cancellation or reductions, even if partial, won't be accepted, excepting indemnity of manufacturing and material costs met up to cancellation. We reserve the right to supply plus/minus 5% of the quantity ordered.

2) PRICES - Prices are the effective ones at order-date. All prices have to be understood Ex-factory, excluding packing. Should increases in manufacturing costs, materials and so on, take place between the date of our order-confirmation and completion of order, our prices will be amended accordingly without prior notice being given.

3) DELIVERY TERMS - Only the deliverytime stated by Messrs BEA INGRANAGGI S.p.A. must be considered valid. The quoted terms of delivery are without engagement, i.e. not legally binding. Indemnification claims for non-fulfilment of/or belated deliveries are not accepted. The purchaser is not entitled to refuse part deliveries. The purchaser is forced to accept the deliveries to our normal working. Unforeseen events such as force majeure, breakdown, transportation delays, difficulties in supply of raw material, strikes, lockouts in our or in the plants of our suppliers, likewise wastage involving extra production, entitle us to postpone delivery for the period of the handicap and an appropriate new start or to cancel the uncompleted part.

4) DESPATCHES - The despatch of goods, including freight free deliveries is effected to the best judgement but without obligation, and at sole risk of the purchaser. Claims for eventual shortage must be produced within eight (8) days from receipt of goods. If transport freight, even if partially, are paved by Messrs BEA INGRANAGGI S.p.A. they reserve the right to choose the means of conveyance.

5) PACKING - Packing cases are charged at cost.

6) WARRANTY - Messrs BEA INGRANAGGI S.p.A. engage themselves to repair or replace, free of charge, pcs they recognize faulty. Said goods have to be returned free our warehouse, packing and customs included. Warranty decay when pcs returned as wanting, have been repaired or with. Reworking of defective pcs made by the buyer will be recognized only if entitled by Messrs BEA INGRANAGGI S.p.A. after their approval of estimate Messrs BEA INGRANAGGI S.p.A. do not take responsibility upon eventual damages involved in the use of their products, even if defective.

7) PAYMENTS - Will be considered valid on only the payments effected according to terms agreed. When exceeding our payment terms, interest at 3% above the bank interest we have to pay is imposed without formal notice of detention. Non-observance of the payment terms, or circumstances becoming known to us after the conclusion of the contract which are apt to diminish the credit worthiness of the buyer, immediately cause all debts to have matured. In addition, this entitles us to make further deliveries only against payment in advance, or to retire from the contract and claim compensation for non-fulfilment thereof. Withholding or compensation offset is not accepted.

8) PROPERTY - All the goods delivered remain always of property of Messrs. BEA INGRANAGGI S.p.A. up to the time of complete payment of the invoices.

9) COURT OF JUSTICE - In the event of debate the Court of Busto Arsizio (Va) have exclusive jurisdiction for purchaser and seller.

ALLEGEMEINE VERKAUFSBEDINGUNGEN

1) BESTELLUNGEN - Die Bestellungen für Standard- oder Spezial-Ausführung müssen sich auf Offerten der BEA INGRANAGGI S.p.A. beziehen. Die Bestellungen sind für den Kunden verbindlich. Wenn die Arbeit begonnen hat, werden Annullationen oder Reduzierungen nicht mehr angenommen, ausser, dass der Kunde die Kosten für Material und Arbeit bis zur Aufhebung des Auftrages bezahlt. Die Toleranz der gelieferten Ware kann gegenüber der bestellten Menge +/-5% betragen.

2) PREISE - Es gelten diejenigen Preise, die am Tage der Bestellung gültig sind. Die Preise verstehen sich ab Werk Premezzo, ohne Verpackung. Falls während der Lieferzeit sich berechnete Preiserhöhungen für Material und Arbeitskosten einstellen, hat die BEA INGRANAGGI S.p.A. das Recht, die Preise entsprechend anzugleichen, auch für laufende Bestellungen.

3) LIEFERFRIST - Nur die von der BEA INGRANAGGI S.p.A. bestätigten Liefertermine sind gültig, aber nur unverbindlich. Im Falle von Schwierigkeiten in der Materialbeschaffung, Streiks oder andere Fälle von hoher Macht, werden die Liefertermine automatisch verlängert, ohne dass die BEA INGRANAGGI S.p.A. für Schadenansprüche irgendwelcher Art belangt werden kann. Der Kunde ist in jedem Fall verpflichtet, bei Fertigstellung von Spezialanfertigungen die Ware zu beziehen.

4) SPEDITIONEN - Die Speditionen verstehen sich zu Lasten des Auftraggebers und ausgeführt auf dessen Risiko und Gefahr, auch diejenigen franko Haus. Reklamationen wegen eventuellen Mankos müssen innert 8 Tagen nach Erhalt der Sendung gemeldet werden. Wenn vereinbart wird, dass die Transportkosten zu Lasten von BEA INGRANAGGI S.p.A. gehen, auch nur teilweise, so kann diese den günstigsten Speditionsweg wählen.

5) VERPACKUNG - Die Verpackung wird zu Selbstkosten verrechnet.

6) GARANTIE - Die Firma BEA INGRANAGGI S.p.A. verpflichtet sich gratis jene Stücke zu reparieren oder zu ersetzen, welche von ihr als defekt anerkannt werden. Die beanstandete Ware muss frei von allen Spesen der BEA INGRANAGGI S.p.A. zugestellt werden. Die Garantie verfällt, wenn die als defekt retournierten Stücke vom Kunden repariert oder bearbeitet worden sind. Die vom Kunden durchgeführten Reparaturen von defekten Stücken werden von der BEA INGRANAGGI S.p.A. erst nach Prüfung der mitgeteilten Spesen anerkannt. Die BEA INGRANAGGI S.p.A. übernimmt keine Verantwortung, noch anerkennt sie Schäden jeglicher Art, die sich während dem Gebrauch seiner Artikel ergeben, auch wenn diese defekt sind.

7) ZAHLUNGEN - Es werden Zahlungen anerkannt, welche zum vereinbarten Termin erfolgen. Wenn der Zahlungstermin abgelaufen ist, berechnet die BEA INGRANAGGI S.p.A. Verzugszinsen von 3% über dem normalen Zins, behält sich das Recht vor die Zahlung zu verlangen. Bei verspäteter oder Nichtzahlung des Kunden, behält sich die BEA INGRANAGGI S.p.A. das Recht vor, Lieferungen von laufenden Aufträgen einzustellen oder Vorauszahlung zu verlangen, ohne Schadenansprüche oder Entschädigungen aller Art zu gewähren. Jede Anfechtung der Materialien in Fabrikation oder schon im Besitze des Kunden, befreit diesen nicht zur Zahlung auf den festgesetzten Termin und zwar für die ganze Summe der Faktura, ohne jeglichen Abzug.

8) EINGENTUMSVORBEHALT - Alle gelieferten Waren bleiben Eigentum der BEA INGRANAGGI S.p.A. bis zur vollständigen Bezahlung der Fakturen

9) Gerichtsstand und Erfüllungsort - Bei allen sich aus den Geschäftsbeziehungen ergebenden Streitigkeiten ist das Gericht von BUSTO ARSIZIO zuständig.

CONDITIONS GENERALES DE VENTE

1) COMMANDES - Les commandes pour du matériel standard ou spécial se réfèrent toujours aux offres de Prix de la BEA INGRANAGGI S.p.A. Les commandes sont fermes et définitives. Une fois que l'usinage des articles est commencé nous n'acceptons plus les annulations ni les réductions de commande à moins que le client nous règle les coûts des matériaux et de l'usinage réalisé au moment de la suspension. La quantité expédiée peut varier de ±5% par rapport à la quantité commandée.

2) PRIX - Ils sont ceux en vigueur à la date de la commande. Tous les prix s'entendent pour marchandise départ PREMEZZO. Emballage exclu. Si pendant la livraison il se vérifie des augmentations de matière première où dans les autres coûts de production la BEA INGRANAGGI S.p.A. aura la faculté d'adapter ses prix, même pour les commandes en cours.

3) DELAIS DE LIVRAISON - Sont seules valables les délais de livraison confirmés par la BEA INGRANAGGI S.p.A. Ils s'entendent toutefois indicatifs. En cas de force majeure (difficulté d'approvisionnement les matériaux, grèves etc.), les délais seront automatiquement prorogés sans que la BEA INGRANAGGI S.p.A. soit tenue de verser des intérêts ou de pénalités de toute sorte.

4) EXPEDITIONS - Les expéditions sont à la charge du client à ses risques et périls même en envoi Franco de Port. Les réclamations pour des manques éventuels doivent parvenir 8 jours francs à réception de marchandise. Au cas où la BEA INGRANAGGI S.p.A. prend en charge, même partiellement le coût du transport, elle se réserve le droit de choisir le moyen du transport le plus économique.

5) EMBALLAGE - Il est facturé au coût. Nous n'acceptons pas de retour.

6) GARANTIE - La BEA INGRANAGGI S.p.A. s'engage à réparer ou substituer gratuitement les pièces reconnues défectueuses. La marchandise contestée doit être rendue au siège Franco de toute dépense. La garantie n'est pas applicable si les pièces ont été retouchées. Leur réparation est acceptée uniquement si une autorisation est accordée par la BEA INGRANAGGI S.p.A. La garantie ne couvre pas l'usage qui est fait de nos produits.

7) PAIEMENTS - Ne seront reconnus valables que les règlements effectués dans les modes et termes accordés. En cas de délais de règlement dépassés la BEA INGRANAGGI S.p.A. comptera les intérêts de retard au taux de 3% supérieur à celui légal. De même elle suspendra les livraisons des commandes en cours et prétendra le règlement anticipé sans reconnaître au client aucune indemnité. Aucun prétexte que ce soit même litigieux ne peut retarder ou modifier les termes de paiement.

8) PROPRIETE - Toute marchandise expédiée reste la propriété de la BEA INGRANAGGI S.p.A. jusqu'à son paiement complet.

9) JURIDICTION - En cas de contestations seules seront compétentes les juridictions de notre Siège Social. Le Tribunal compétent est celui de BUSTO ARSIZIO (I).



BEA INGRANAGGI S.p.A.

21044 Cavaria con Premezzo (VA) - ITALY - Via Tito Minniti, 158
Tel. +39 0331 214.111 - Fax +39 0331 214.222
bea@beaingranaggi.com
www.beaingranaggi.com



BEA INGRANAGGI S.p.A. - Padova

35010 Villafranca Padovana (PD) - Viale delle Industrie, 9
Tel. +39 049 907.0422 - +39 049 761.699
Fax +39 049 761.997
padova@beaingranaggi.com



LUFRA S.A.

26740 Montboucher sur Jabron - FRANCE
Z.A Fontgrave - 50 Rue Denis Papin
Tel. +33 475 468.811
Fax +33 475 468.606
commercial@lufra.fr
www.lufra.fr



BEA ANTRIEBSTECHNIK GmbH

72666 Neckartailfingen - GERMANY
Neckarstraße, 14
Tel. +49 7127 980.120
Fax +49 7127 980.1222
info@bea-antriebstechnik.de
www.bea-antriebstechnik.de



BEA TRANSMISION 98 S.L.

20829 Itziar - Deba (Guipúzcoa) - SPAIN
Parque Empresarial Itziar, Parcela 4, Sector F-2, Naves 2-3
Tel. +34 943 199.464
Fax +34 943 199.458
comercial@beatransmision.com
www.beatransmision.com

DAN-BELT TRANSMISION INDUSTRIAL S.L.

08980 Sant Feliu De Llobregat (Barcelona) - SPAIN
Calle Agricultura 17, Poligono El Pla, Naves 6-8-10
Tel. +34 936 327 300
danbelt@danbelt.com
www.danbelt.com

DAN-BELT

