



Pressure regulating valve

Size 1

Pressure supply at both ends

RB 11

G 1/4

0.1 to 3 bar

0.2 to 6 bar

0.5 to 10 bar

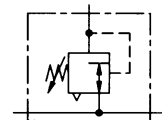

Characteristics

Type	RB 11
Port	G 1/4
p₁	G 1/4
p₂	G 1/4
Pressure gauge port	G 1/8
Type of construction	Diaphragm pressure regulator with self-relieving design Lockable adjusting knob on request
Max. input pressure p ₁	16 bar
Control range p ₂	0.1 to 3 bar / 0.2 to 6 bar 0.5 to 10 bar / 0.5 to 16 bar on request
Mounting position	Any
Mounting type	Panel mounting, hole Ø30.5 Mounting bracket
Medium temperature	Max. 60°C
Ambient temperature	Max. 60°C
Weight [g]	330 / 415 with pressure gauge

Typical application

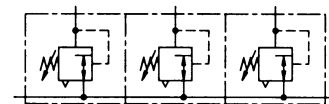

Ordering information

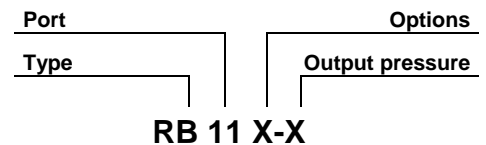

Port	
11	G 1/4
Options	
K	Lockable adjusting knob

Order example: RB 11 K-10

Materials

Part	Material
Head piece (body)	Z 410
Spring bonnet	POM-brass
Diaphragm	→ NBR-brass
Pressure spring	Galvanised steel
Valve cone with plastic pressure pin	→ NBR-brass-POM
Counter-pressure spring	Stainless steel
O-ring 30 x 2	→ NBR
Bottom screw	POM
Spring bonnet, lockable	POM-Al
Lock cylinder	Brass

Description

- Simple block mounting without tools using conical clamps
- Joiner sets (**KP 11**) required for block mounting
- Pressure setting can be locked by pushing the knob down
- Flow direction indicated by arrows
- **Entry in direction of arrow**
- **Independent of inlet pressure**
- Pressure gauge Ø40 included
- Lockable adjusting knob (**on request**)

Main spare parts

Part	Part No.
→ Set of wearing parts	22.1811.4
- Diaphragm, compl.	
- Valve cone, compl.	
- O-ring 30 x 2	
Pr. gauge Ø40, G 1/8	
0 to 4 bar	110.44-KD
0 to 10 bar	110.46-KD
0 to 16 bar	110.47-KD
0 to 25 bar	110.37-KDB

Accessories

Designation	Order No.
Nut M 30 x 1.5	R 11-55
Mounting bracket with nut R 11-55	MV 30
Mounting bracket with two screws	ZW 11
Joiner set for block mounting with other devices	KP 11
Joiner set for narrow diverter block	KP 11 Z

Dimensions [mm]

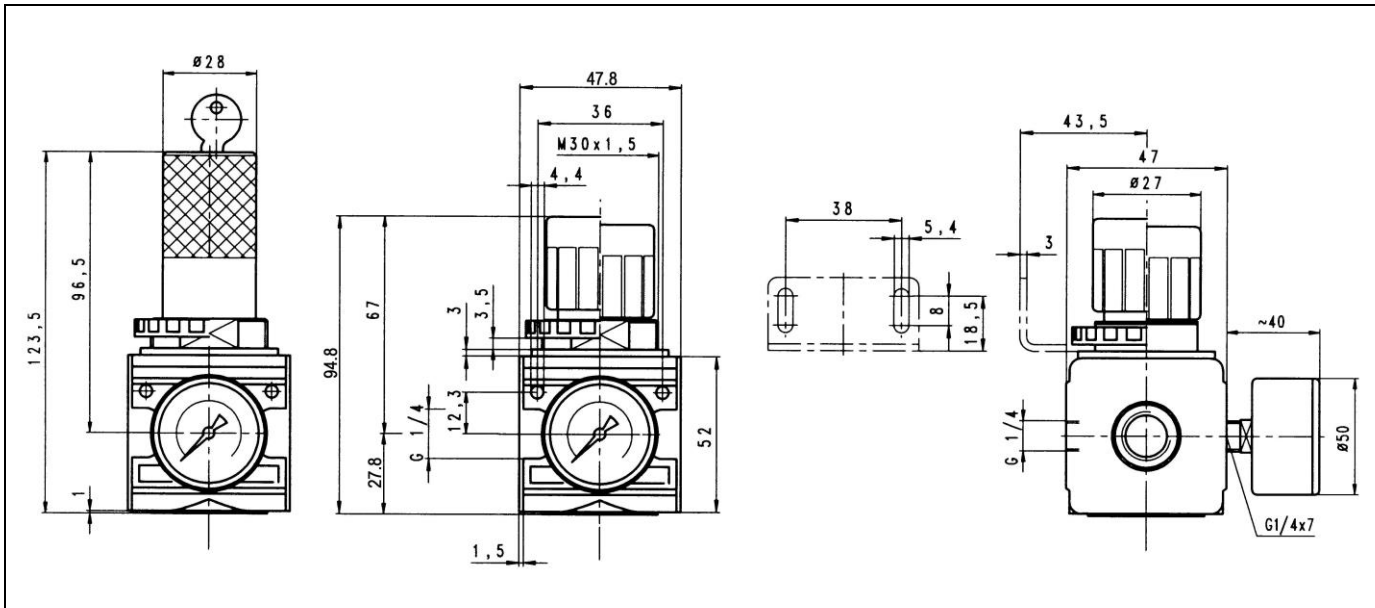

Hysteresis

Hysteresis of p_2 as a function of rising (falling) p_1 at a constant draw-off rate Q_N 20 l/min
 Basic setting (starting point): p_1 : 7.0 bar
 p_2 : 2.0 bar

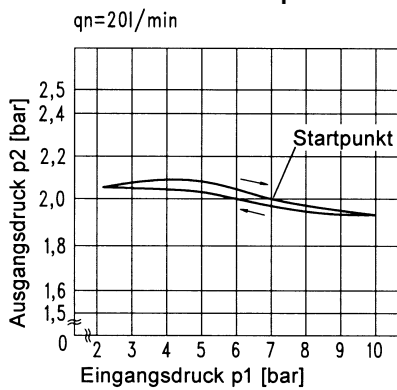

Flow characteristic

Control range 0.5 to 10 bar

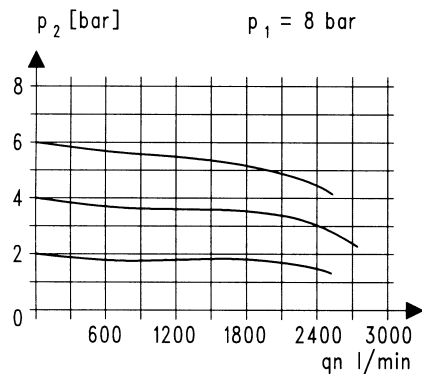

Flow rates

Flow rates at $p_1 = 8$ bar

Art. No.		RB 11-3	RB 11-6	RB 11-10
Output pressure $p_2 = 6$ [bar]	Q_N m ³ /h	120	120	120
Nominal flow ($\Delta p = 1$ bar)	l/min	2000	2000	2000

Typical application

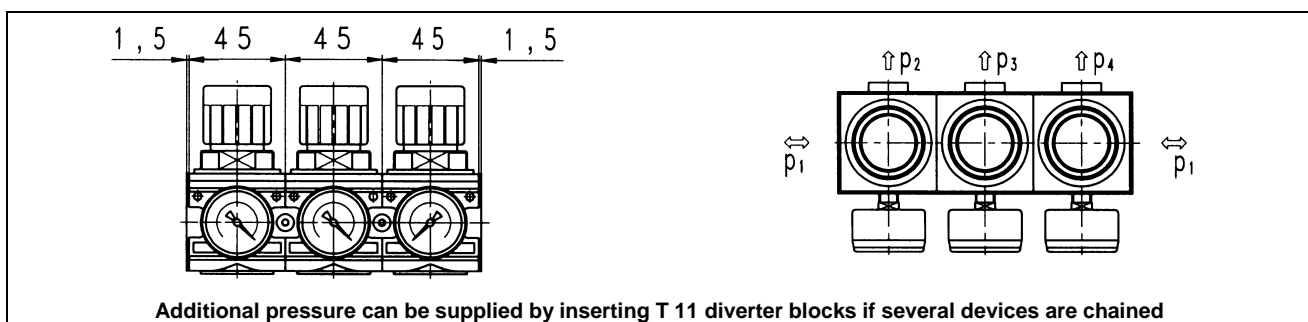

Additional pressure can be supplied by inserting T 11 diverter blocks if several devices are chained